

## OPERATING MANUAL

### AC speed control motor

#### SCM Motor

Right Angle Shaft  
Hypoid Gear JH/JL Gearhead



### Introduction

#### Before using the motor

Only qualified personnel should work with the product. Use the product correctly after thoroughly reading the section "Safety precautions." In addition, be sure to observe the contents described in warning, caution, and note in this manual. The product described in this manual has been designed and manufactured to be incorporated in general industrial equipment. Do not use for any other purpose. Oriental Motor Co., Ltd. is not responsible for any damage caused through failure to observe this warning.

#### Related operating manuals

Operating manuals for this product are listed below. Operating manuals are not included with the product. Download from Oriental Motor Website Download Page or contact your nearest Oriental Motor sales office.

	Operating manual name
Motor	SCM Motor Right Angle Shaft Hypoid Gear JH/JL Gearhead OPERATING MANUAL (this document)
Speed controller	DSC Series OPERATING MANUAL US2 Series OPERATING MANUAL

Refer to the operating manuals of the speed controller for details about connections and operations.

### Safety precautions

The precautions described below are intended to prevent danger or injury to the user and other personnel through safe, correct use of the product. Use the product only after carefully reading and fully understanding these instructions.

<b>WARNING</b>	Handling the product without observing the instructions that accompany a "WARNING" symbol may result in serious injury or death.
<b>CAUTION</b>	Handling the product without observing the instructions that accompany a "CAUTION" symbol may result in injury or property damage.
<b>Note</b>	The items under this heading contain important handling instructions that the user should observe to ensure safe use of the product.

**Description of graphic symbols**

- Indicates "prohibited" actions that must not be performed.
- Indicates "compulsory" actions that must be performed.

<b>WARNING</b>	
	<ul style="list-style-type: none"> <li>Do not use the product in explosive or corrosive environments, in the presence of flammable gases, in places subjected to splashing water, or near combustibles. Doing so may result in fire, electric shock or injury.</li> <li>Do not transport, install the product, perform connections or inspections when the power is on. Always turn the power off before carrying out these operations. Failure to do so may result in electric shock or equipment damage.</li> <li>Do not use the brake mechanism of the electromagnetic brake motor as a safety brake. Doing so may result in injury or damage to equipment.</li> <li>Do not machine or modify the cable. Doing so may result in fire, electric shock or damage to equipment.</li> <li>Do not forcibly bend, pull or pinch the cables. Doing so may result in fire, electric shock or damage to equipment.</li> <li>Do not touch the motor when conducting insulation resistance measurement or dielectric strength test. Accidental contact may result in electric shock.</li> <li>Do not disassemble or modify the motor. This may cause electric shock, injury or damage to equipment.</li> </ul>
	<ul style="list-style-type: none"> <li>Only qualified and educated personnel should be allowed to perform installation, connection, operation and inspection/troubleshooting of the product. Handling by unqualified and uneducated personnel may result in fire, electric shock, injury or equipment damage.</li> <li>Use an electromagnetic brake motor in an application of vertical drive such as elevating equipment. If a motor without an electromagnetic brake is used, the moving part may drop. This may result in injury or damage to equipment.</li> </ul>

Thank you for purchasing an Oriental Motor product.

This Operating Manual describes product handling procedures and safety precautions.

- Please read it thoroughly to ensure safe operation.
- Always keep the manual where it is readily available.

### **WARNING**

	<ul style="list-style-type: none"> <li>The motor is Class I equipment. When installing the motor, ground the Protective Earth Terminal of the motor. Failure to do so may result in electric shock.</li> <li>Keep the input power voltage within the specified range. Failure to do so may result in fire or electric shock.</li> <li>Use a motor and speed controller only in the specified combination. An incorrect combination may cause in fire, electric shock or equipment damage.</li> <li>Always turn off the power before performing maintenance/inspection. Failure to do so may result in electric shock.</li> </ul>
--	--

### **CAUTION**

	<ul style="list-style-type: none"> <li>Do not use the motor beyond its specifications. Doing so may result in electric shock, injury or damage to equipment.</li> <li>Do not touch the motor during operation or immediately after stopping. The surface is hot and may cause a skin burn(s).</li> <li>Keep the area around the motor free of combustible materials. Failure to do so may result in fire or a skin burn(s).</li> <li>Do not leave anything around the motor that would obstruct ventilation. Doing so may result in damage to equipment.</li> <li>Do not lift up the product by holding the output shaft or the cable. Doing so may result in injury.</li> <li>Do not touch the motor output shaft end with bare hands. Doing so may result in injury.</li> <li>When assembling the motor with the gearhead, exercise caution not to pinch your fingers or other parts of your body between the motor and gearhead. Injury may result.</li> <li>When installing the motor in the equipment, exercise caution not to pinch your fingers or other parts of your body between the equipment and motor. Injury may result.</li> <li>Do not touch the rotating part (output shaft) while operating the motor. Doing so may result in injury.</li> </ul>
	<ul style="list-style-type: none"> <li>When an abnormality is noted, turn off the power immediately. Failure to do so may result in fire, electric shock or injury.</li> <li>Securely install the motor to the mounting plate. Inappropriate installation may cause the motor to detach and fall, resulting in injury or equipment damage.</li> <li>Provide a cover on the rotating part (output shaft). Failure to do so may result in injury.</li> <li>Securely install the load on the output shaft. Inappropriate installation may result in injury.</li> <li>Be sure to ground the motor to prevent it from being damaged by static electricity. Failure to do so may result in fire or damage to equipment.</li> <li>The motor surface temperature may exceed 70 °C (158 °F) even under normal operating conditions. If the operator is allowed to approach a running motor, attach a warning label as shown in the figure in a conspicuous position.</li> </ul>



### Precautions for use

This section covers restrictions and requirements the user should consider when using the product.

#### • Be sure to match the output power and power supply voltage when combining a motor and speed controller

#### • Connecting the motor and speed controller

Use a connection cable (sold separately) when extending the wiring distance between the motor and the speed controller.

#### • Use an electromagnetic brake motor in an application of vertical drive such as elevating equipment

When the motor is used in an application of vertical drive such as elevating equipment (lifting and lowering device), use an electromagnetic brake motor so that the load can be held in position.

#### • Caution when using under low temperature environment

When an ambient temperature is low, since the load torque may increase by the viscosity increment of the oil seal or grease, the motor starting may take a long time or the motor rotation speed may fall. However, if the operation is continued for a while, the oil seal or grease will be warmed up, and the motor can be driven at the normal rotation speed.

● **Do not forcibly stop the shaft rotation of gearhead by an external force**  
Stopping in such a way may cause impact, leading to damage to the gearhead.

● **Rotation direction of the output shaft**

The rotation direction of the gearhead output shaft with respect to the motor output shaft is shown in the figure below. (As viewed from the gear flange side)

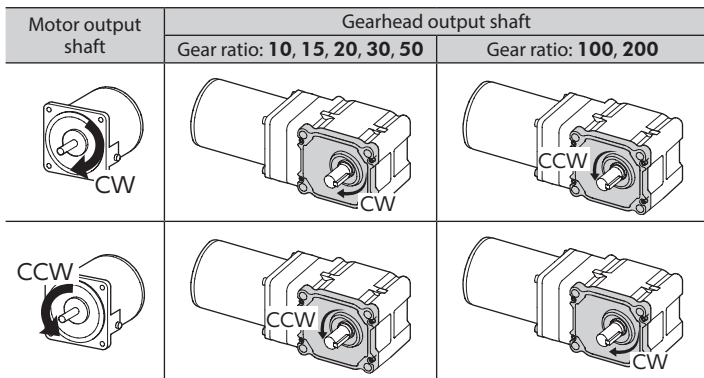

For the hollow shaft type:

When viewing from the opposite side of the gear flange side, the gearhead output shaft rotates in the opposite direction to the above figure.

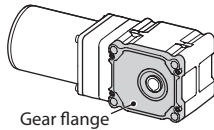

**About gear ratio**

● **Gear ratio and actual reduction ratio**

The gear ratio in the model name differs from the actual reduction ratio of the gearhead. Check the actual reduction ratio in the table below.

Gear ratio	10	15	20	30	50	100	200
Actual reduction ratio	10.25	15.38	20.50	30.75	51.25	102.5	205.0

**Preparation**

■ **Checking the product**

Verify that the items listed below are included. Report any missing or damaged items to the branch or sales office from which you purchased the product.

- |  |   |
|--|---|
| <input type="checkbox"/> Motor.....1 unit<br>Pre-assembled with a gearhead   | <b>Hollow shaft JH Gearhead</b>   |
| <input type="checkbox"/> Mounting screw set.....1 set<br>Hexagonal socket head screw, plain washer, spring washer 4 pieces each<br>Material: Stainless steel | <input type="checkbox"/> Safety cover.....1 piece<br><input type="checkbox"/> Parallel key.....1 piece<br>Material: Stainless steel |
| <input type="checkbox"/> Instructions and Precautions for Safe Use ...1 copy   | <b>Solid shaft JL Gearhead</b>  |
|  | <input type="checkbox"/> Parallel key.....1 piece<br>(Secured to the output shaft)<br>Material: Iron                                |

■ **Checking the model name**

Check the model names of the motor and the gearhead against the model name described on each nameplate.

Tell us the model name, product serial number, and manufacturing date when you contact us. For the information about the nameplate, check the operating manual of the speed controller. The figures show the Hollow shaft.

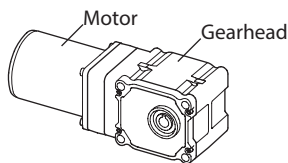

- Enter the code representing the power supply voltage in the box ■ within the model name.  
**JA:** Single-phase 100 V 50/60 Hz    **JC:** Single-phase 200 V 50/60 Hz  
**UA:** Single-phase 110/115 V 60 Hz    **EC:** Single-phase 220/230 V 50/60 Hz
- Enter the number representing the gear ratio of the gearhead in the box □ within the model name.
- In the case of the an electromagnetic brake motor, enter "M" in the box ◇ within the model name.

● **Hollow shaft JH Gearhead**

Output power	Model	Motor model	Gearhead model
25 W	SCM425K■◇-4H□B	SCM425K■◇	4H□B
40 W	SCM540K■◇-5H□B	SCM540K■◇	5H□B
90 W	SCM590K■◇-5H□B	SCM590K■◇	

● **Solid shaft JL Gearhead**

Output power	Model	Motor model	Gearhead model
25 W	SCM425K■◇-4L□B	SCM425K■◇	4L□B
40 W	SCM540K■◇-5L□B	SCM540K■◇	5L□B
90 W	SCM590K■◇-5L□B	SCM590K■◇	

**Installation**

This section explains the installation method of a load in addition to the installation location and installation method of the product.

■ **Installation location**

Install the product in a well-ventilated location that provides easy access for inspection.

- Indoors
- Operating ambient temperature 0 to +40 °C [+32 to +104 °F] (non-freezing)
- Operating ambient humidity 85% or less (non-condensing)
- Area that is free from an explosive atmosphere or toxic gas (such as sulfuric gas) or liquid
- Area not exposed to direct sun
- Area free of excessive amount dust, iron particles or the like
- Area not subject to splashing water (storms, water droplets), oil (oil droplets) or other liquids
- Area free of excessive salt
- Area not subject to continuous vibration or excessive shocks
- Area free of excessive electromagnetic noise (from welders, power machinery, etc.)
- Area free of radioactive materials, magnetic fields or vacuum
- Altitude Up to 1000 m (3300 ft.) above sea level

**Note**

On rare occasions, grease may ooze out from the gearhead. If there is a concern over possible environmental damage resulting from the leakage of grease, provide an oil tray or similar oil catching mechanism in order not to cause a secondary damage. Grease leakage may lead to problems in the customer's equipment or products.

■ **Installation method**

Secure the motor with mounting screw set (included) through the four mounting holes provided. Do not leave a gap between the motor and mounting plate. The figures show the Hollow shaft.

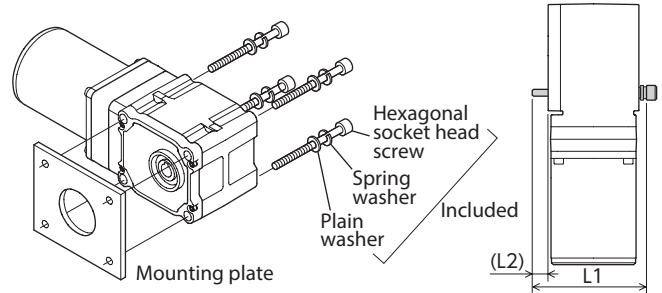

Model	Hexagonal socket head screw		L2	Tightening torque
	Screw size	L1		
SCM425	M6	95 mm (3.74 in.)	11 mm (0.43 in.)	5.0 N·m (44 lb·in)
SCM540, SCM590	M8	110 mm (4.33 in.)	10 mm (0.39 in.)	12.0 N·m (106 lb·in)

**Note**

When the motor is installed to equipment using the mounting surface of the gearhead, proper alignment between the hollow shaft inside dimension and the load shaft is necessary. Keep the alignment tolerance within 0.02 mm (0.0008 in.). Insufficient alignment may result in damage to the gearhead internal bearings.

**Removing and assembling the gearhead**

This is the procedure for when the gearhead is removed and replaced.

● **Removing the gearhead from the motor**

Remove the hexagonal socket head screws (4 pieces) assembling the motor and gearhead, and detach the gearhead from the motor.

The figures show the Hollow shaft.

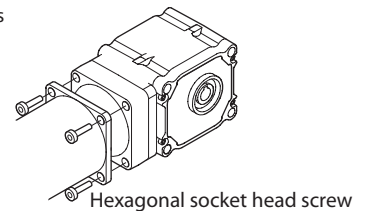

● **Assembling the gearhead to the motor**

Combine the gearhead with the motor and tighten the hexagonal socket head screws. Check the key is fitted to the motor output shaft before assembling them. When assembling, apply anti-seizing agent such as molybdenum disulfide grease on the surface of the motor shaft and on the bore of the motor shaft input part in the gearhead. Also, confirm that no gaps remain on the mating face of the motor and gearhead.

Model	Screw size	Material	Tightening torque
SCM425	M5	Stainless steel	3.0 N·m (26 lb·in)
SCM540, SCM590	M6		5.0 N·m (44 lb·in)

**Note**

- Do not forcibly assemble the motor and gearhead. The motor output shaft or the gearhead input part may be damaged, resulting in noise or shorter service life.
- Do not allow dust to attach to the pilot sections of the motor and gearhead.
- The hexagonal socket head screws assembling the motor and gearhead are used to attach the motor and gearhead temporarily. Be sure to use the included mounting screw set to install the motor.

**Motor with cooling fan**

When installing a motor with cooling fan onto a device, leave 10 mm (0.39 in.) or more behind the fan cover or open a ventilation hole so that the cooling inlet on the back of the motor cover is not blocked.

**Installing a load to the hollow shaft type**

Mounting method of the load varies depending on the load shaft conditions. See the following figures.

The hollow output shaft inside dimension is processed to a tolerance of H8, and incorporates a key slot for load shaft attachment. A load shaft tolerance of h7 is recommended. Also, apply anti-seizing agent such as molybdenum disulfide grease, on the surface of the load shaft and the bore of the hollow output shaft in order to prevent seizure.

A load can be installed to the hollow output shaft from either right face or left face in the following figure.

**Stepped load shaft**

**Mounting method using end plate**

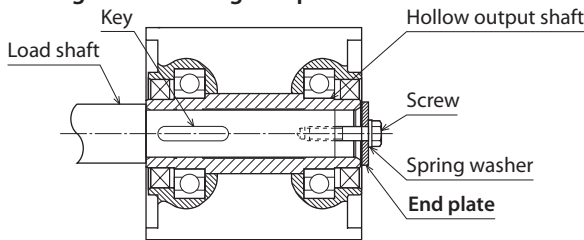

**Mounting method using retaining ring**

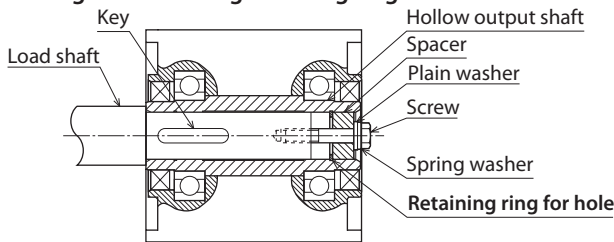

**Non-stepped load shaft**

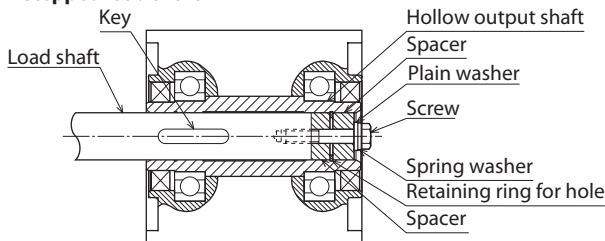

**Note**

Do not apply excessive or abrupt force to the hollow output shaft when inserting a load shaft into the hollow output shaft. Excessive or abrupt force may damage the gearhead internal bearings.

**Recommended load shaft installation dimensions**

Unit : mm (in.)

Model	SCM425	SCM540, SCM590
Inner Diameter of Hollow Shaft (H8)	$\varnothing 12^{+0.027}_0$ ( $\varnothing 0.4724^{+0.0011}$ )	$\varnothing 15^{+0.027}_0$ ( $\varnothing 0.5906^{+0.0011}$ )
Shaft Diameter of Load Shaft (h7)	$\varnothing 12^{-0.018}_0$ ( $\varnothing 0.4724^{-0.0007}$ )	$\varnothing 15^{-0.018}_0$ ( $\varnothing 0.5906^{-0.0007}$ )
Length of Stepped Shaft La	55 (2.17)	72 (2.83)
Screw size	M5	M6
Spacer dimension	Outer diameter	$\varnothing 11.5$ ( $\varnothing 0.45$ )
	Inner diameter	$\varnothing 6$ ( $\varnothing 0.24$ )
	Width	3 (0.12)
Nominal diameter of retaining ring (C-type retaining ring)	$\varnothing 12$ ( $\varnothing 0.47$ )	$\varnothing 15$ ( $\varnothing 0.59$ )
End plate thickness	3 (0.12)	3 (0.12)

- Retaining rings for holes, spacers, screws and other parts used to install the load shaft are not included. They are to be supplied by the customer.

**Recommended load shaft length**

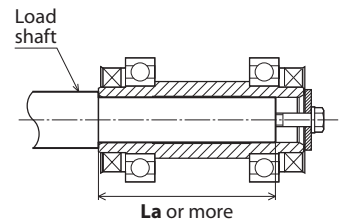

**Installing the safety cover**

After installing the load, attach the included safety cover.

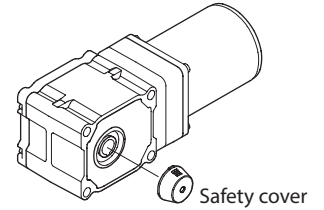

**Installing a load to the solid shaft type**

The gearhead output shaft has been machined to an outer diameter tolerance of h7 and provided with a key slot for connecting the transmission parts.

When connecting the transmission parts, ensure that the shaft and parts have a clearance fit, and always fix the parallel key to the output shaft with a screw to prevent the parts from rattling or spinning.

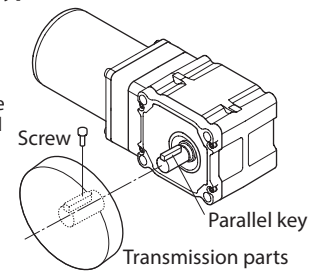

**Note**

Do not apply excessive force onto the output shaft of the gearhead using a hammer or other tools. Doing so may cause damage to the output shaft or bearings.

**Permissible radial load and permissible axial load**

The radial load and the axial load on the gearhead output shaft must be kept under the permissible values listed below.

**Note**

Failure due to fatigue may occur when the gearhead bearings and output shaft are subject to repeated loading by a radial or axial load that is in excess of the permissible limit.

**Hollow shaft JH Gearhead**

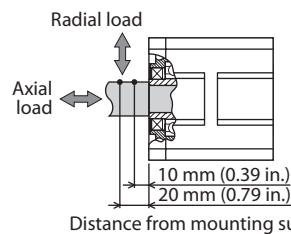

**Solid shaft JL Gearhead**

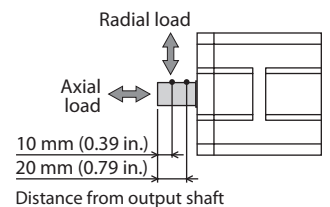

Model	Hollow shaft JH Gearhead		Solid shaft JL Gearhead		Permissible axial load [N (lb.)]	
	Permissible radial load [N (lb.)]					
	Distance from mounting surface	Distance from tip of gearhead output shaft	Distance from mounting surface	Distance from tip of gearhead output shaft		
SCM425	10 mm (0.39 in.)	20 mm (0.79 in.)	10 mm (0.39 in.)	20 mm (0.79 in.)	88 (19.8)	
	10	311 (69)	265 (59)	304 (68)		390 (87)
	15	400 (90)	341 (76)	390 (87)		501 (112)
	20	488 (109)	417 (93)	477 (107)		613 (137)
	30	622 (139)	531 (119)	607 (136)		780 (175)
	50	799 (179)	682 (153)	781 (175)		1003 (220)
SCM540 SCM590	10 mm (0.39 in.)	20 mm (0.79 in.)	10 mm (0.39 in.)	20 mm (0.79 in.)	245 (55)	
	10	888 (199)	758 (170)	868 (195)		1114 (250)
	15	978 (220)	836 (188)	956 (210)		1228 (270)
	20	978 (220)	836 (188)	956 (210)		1228 (270)
	30	1112 (250)	971 (210)	1011 (220)		1287 (280)
	50	1196 (260)	1045 (230)	1089 (240)		1385 (310)
SCM540 SCM590	10 mm (0.39 in.)	20 mm (0.79 in.)	10 mm (0.39 in.)	20 mm (0.79 in.)	343 (77)	
	10	415 (93)	363 (81)	378 (85)		481 (108)
	15	554 (124)	484 (108)	504 (113)		641 (144)
	20	692 (155)	605 (136)	630 (141)		802 (180)
	30	923 (200)	806 (181)	840 (189)		1069 (240)
	50	1112 (250)	971 (210)	1011 (220)		1287 (280)

## Grounding

### ● Connecting Protective Earth Terminal

Be sure to ground the product using the Protective Earth Terminal on the motor.

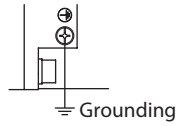

[mm (in.)]

Applicable crimp terminal:  
Round crimp terminal with insulation cover  
Terminal screw size: M4  
Tightening torque:  
1.0 to 1.3 N·m (8.8 to 11.5 lb-in)  
Applicable minimum lead wire size:  
AWG18 (0.75 mm<sup>2</sup>) or thicker

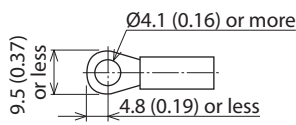

**Note** Be sure to use the screw for grounding attached on the product.

## Time rating

Continuous operation is possible (continuous rating).

## Maintenance · inspection

### ■ Inspection

It is recommended that periodic inspections would be conducted for the items listed below after each operation of the motor. If an abnormal condition is noted, discontinue any use and contact your nearest Oriental Motor sales office.

**Note** Do not conduct the insulation resistance measurement or dielectric strength test with the motor and speed controller connected. Doing so may cause damage to the product.

### ● Inspection item

- Check if any of the mounting screws of the motor and gearhead are loose.
- Check if the bearing part (ball bearings) of the motor generates unusual noises.
- Check if the bearing part (ball bearings) or gear meshing part of the gearhead generates unusual noises.
- Check if the output shaft of the motor and gearhead and a load shaft are out of alignment.
- Check if a damage or stress is applied on the cable or the connection part between the cable and speed controller is loose.

### ■ Warranty

Check on the Oriental Motor Website for the product warranty.

### ■ Disposal

Dispose the product correctly in accordance with laws and regulations, or instructions of local governments.

## Specifications

Check on the Oriental Motor Website for the product specifications.

### General specifications

Operation environment	Ambient temperature	Classification representing the power supply voltage 0 to +40 °C [+32 to +104 °F] (non-freezing)
	Ambient Humidity	85% or less (non-condensing)
	Altitude	Up to 1000 m (3300 ft.) above sea level
	Surrounding atmosphere	No corrosive gas, dust, water or oil. Cannot be used in radioactive materials, magnetic field, vacuum or other special environment.
Vibration		Not subject to continuous vibrations or excessive impact. In conformance with JIS C 60068-2-6 "Sinewave vibration test method"
		Frequency range: 10 to 55 Hz Pulsating amplitude: 0.15 mm (0.006 in.) Sweep direction: 3 directions (X, Y, Z) Number of sweeps: 20 times
Storage environment	Ambient temperature	-10 to +60 °C [+14 to +140 °F] (non-freezing)
	Ambient Humidity	85% or less (non-condensing)
Shipping environment	Altitude	Up to 1000 m (3300 ft.) above sea level
	Surrounding atmosphere	No corrosive gas, dust, water or oil. Cannot be used in radioactive materials, magnetic field, vacuum or other special environment.
Overheat Protection Device		Built-in thermal protector (automatic return type) Open (motor standstill) ..... 130±5 °C (266±9 °F) Close (resuming operation) .... 85±20 °C (185±36 °F)
Degree of protection		IP20

## Regulations and standards

### ■ UL Standards, CSA Standards

This product is recognized by UL under the UL and CSA Standards. The motor model name represents the model that conforms to the standards.

Applicable standards	Certification Body / File No.
UL 1004-1, UL 1004-3 CSA C22.2 No.100, CSA C22.2 No.77	UL/E64197

- Thermal Class: 130 (B)

### ■ CCC System

This product is affixed the CCC Mark under the China Compulsory Certification System. It is also certified by CQC.  
Applications standards: GB/T 12350

### ■ CE Marking

This product is affixed the CE Marking under the Low Voltage Directive.

### ● Low Voltage Directive

#### Applicable standards

EN 60034-1, EN 60034-5, EN 60664-1

Momentary excess torque based on EN 60034-1

Model	Momentary excess torque	Momentary excess torque represents a maximum torque that can maintain the operation for 15 seconds without stalling or abrupt speed change even if the torque is increased gently while operating at rated voltage and rated frequency.
SCM425 SCM540 SCM590	130% of the rated torque	

### Installation conditions (For EN standard)

Overvoltage category II, Pollution degree 2, Class I equipment

When the machinery to which the motor is mounted requires overvoltage category III specifications, install the motor in a cabinet that connect to power supply via an isolation transformer.

### Motor temperature rise tests

Temperature rise tests required by the above standards are performed in a state that has been attached a heat radiation plate instead of a gearhead.  
The size and material for the heat radiation plates are as follows.

Model	Size [mm (in.)]	Thickness [mm (in.)]	Material
SCM425	135×135 mm (5.31×5.31 in.)	5 (0.20)	Aluminum alloy
SCM540	165×165 mm (6.50×6.50 in.)		
SCM590	200×200 mm (7.87×7.87 in.)		

### ■ RoHS Directive

The products do not contain the substances exceeding the restriction values of RoHS Directive (2011/65/EU).

- Unauthorized reproduction or copying of all or part of this manual is prohibited.
- Oriental Motor shall not be liable whatsoever for any problems relating to industrial property rights arising from use of any information, circuit, equipment or device provided or referenced in this manual.
- Characteristics, specifications and dimensions are subject to change without notice.
- While we make every effort to offer accurate information in the manual, we welcome your input. Should you find unclear descriptions, errors or omissions, please contact the nearest office.
- **Oriental motor** is a registered trademark or trademark of Oriental Motor Co., Ltd., in Japan and other countries.

© Copyright ORIENTAL MOTOR CO., LTD. 2018

Published in April 2021

- Please contact your nearest Oriental Motor office for further information.

ORIENTAL MOTOR U.S.A. CORP.  
Technical Support Tel:800-468-3982  
8:30am EST to 5:00pm PST (M-F)  
www.orientalmotor.com

ORIENTAL MOTOR (EUROPA) GmbH  
Schiesstraße 44, 40549 Düsseldorf, Germany  
Technical Support Tel:00 800/22 55 66 22  
www.orientalmotor.de

ORIENTAL MOTOR (UK) LTD.  
Tel:+44-1256347090  
www.oriental-motor.co.uk

ORIENTAL MOTOR (FRANCE) SARL  
Tel:+33-1 47 86 97 50  
www.orientalmotor.fr

ORIENTAL MOTOR ITALIA s.r.l.  
Tel:+39-02-93906347  
www.orientalmotor.it

ORIENTAL MOTOR CO., LTD.  
4-8-1Higashiueno, Taito-ku, Tokyo 110-8536  
Japan  
Tel:+81-3-6744-0361  
www.orientalmotor.co.jp

ORIENTAL MOTOR ASIA PACIFIC PTE. LTD.  
Singapore  
Tel:1800-842-0280  
www.orientalmotor.com.sg

ORIENTAL MOTOR (MALAYSIA) SDN. BHD.  
Tel:1800-806-161  
www.orientalmotor.com.my

ORIENTAL MOTOR (THAILAND) CO., LTD.  
Tel:1800-888-881  
www.orientalmotor.co.th

ORIENTAL MOTOR (INDIA) PVT. LTD.  
Tel:1800-120-1995 (For English)  
1800-121-4149 (For Hindi)  
www.orientalmotor.co.in

TAIWAN ORIENTAL MOTOR CO., LTD.  
Tel:0800-060708  
www.orientalmotor.com.tw

SHANGHAI ORIENTAL MOTOR CO., LTD.  
Tel:400-820-6516  
www.orientalmotor.com.cn

INA ORIENTAL MOTOR CO., LTD.  
Korea  
Tel:080-777-2042  
www.inaom.co.kr