



## OPERATING MANUAL

### 5-Phase Stepping Motor PKP Series

#### Introduction

##### ■ Before use

Only qualified personnel of electrical and mechanical engineering should work with the product.

Use the product correctly after thoroughly reading the "Safety precautions." In addition, be sure to observe the contents described in warning, caution, and note in this manual. The product described in this manual is designed and manufactured to be incorporated in general industrial equipment. Do not use for any other purpose. Oriental Motor Co., Ltd. is not responsible for any compensation for damage caused through failure to observe this warning.

#### Safety precautions

The precautions described below are intended to ensure the safe and correct use of the product, and to prevent the customer and others from exposure to the risk of injury. Use the product only after carefully reading and fully understanding these instructions.

##### Description of signs

	Handling the product without observing the instructions that accompany a "WARNING" symbol may result in serious injury or death.
	Handling the product without observing the instructions that accompany a "CAUTION" symbol may result in injury or property damage.
	The items under this heading contain important handling instructions that the user should observe to ensure the safe use of the product.

##### Description of graphic symbols

	Indicates "prohibited" actions that must not be performed.
	Indicates "compulsory" actions that must be performed.

<b>WARNING</b>	
	<ul style="list-style-type: none"> <li>Do not use the product in explosive or corrosive environments, in the presence of flammable gases, in places subjected to splashing water, or near combustibles. This may cause fire or injury.</li> <li>Do not forcibly bend, pull or pinch the lead wire or cable. This may cause fire.</li> <li>Do not disassemble or modify the product. This may cause injury.</li> </ul>
	<ul style="list-style-type: none"> <li>Assign qualified personnel to the task of installing, wiring, operating/controlling, inspecting and troubleshooting the product. Handling by unqualified personnel may result in fire or injury.</li> <li>Take measures to keep the moving part in position if the product is used in vertical operations such as elevating equipment. Failure to do so may result in injury or damage to equipment.</li> <li>Install the product inside an enclosure. Failure to do so may result in injury.</li> <li>Connect the cables securely according to the wiring diagram. Failure to do so may result in fire.</li> <li>For the power supply, use a DC power supply with reinforced insulation on its primary and secondary sides. Failure to do so may cause electric shock.</li> </ul>

Thank you for purchasing an Oriental Motor product. This Operating Manual describes product handling procedures and safety precautions.

- Please read it thoroughly to ensure safe operation.
- Always keep the manual where it is readily available.

#### CAUTION

	<ul style="list-style-type: none"> <li>Do not use the product beyond its specifications. This may cause injury or damage to equipment.</li> <li>Keep your fingers and objects out of the openings in the product. Failure to do so may result in fire or injury.</li> <li>Do not touch the product while operating or immediately after stopping. This may cause a skin burn(s).</li> <li>Do not carry the motor by holding the motor output shaft, lead wire or cable. Doing so may cause injury.</li> <li>Keep the area around the product free of combustible materials. Failure to do so may result in fire or a skin burn(s).</li> <li>Leave nothing around the product that would obstruct ventilation. Failure to do so may result in damage to equipment.</li> <li>Do not touch the rotating part (output shaft) while operating the motor. Doing so may result in injury.</li> </ul>
	<ul style="list-style-type: none"> <li>Provide a cover over the rotating part (output shaft) of the motor. Failure to do so may result in injury.</li> <li>Use a motor and driver only in the specified combination. Failure to do so may result in fire.</li> <li>Provide an emergency stop device or emergency stop circuit external to the equipment so that the entire equipment will operate safely in the event of a system failure or malfunction. Failure to do so may result in injury.</li> <li>When an abnormal condition has occurred, immediately stop operation to turn off the driver power. Failure to do so may result in fire or injury.</li> <li>The motor surface temperature may exceed 70 °C (158 °F) even under normal operating conditions. If the operator is allowed to approach the motor in operation, affix a warning label shown in the figure on a conspicuous position. Failure to do so may result in a skin burn(s).</li> </ul>



#### Precautions for use

- **When conducting the insulation resistance measurement or the dielectric strength test, be sure to separate the connection between the motor and the driver.**

Conducting the insulation resistance measurement or dielectric strength test with the motor and driver connected may result in damage to the product.

- **Do not apply a radial load and axial load in excess of the specified permissible limit**

Operating the motor under an excessive radial load or axial load may damage the motor bearings (ball bearings). Be sure to operate the motor within the specified permissible limit of radial load and axial load.

- **Motor surface temperature**

The surface temperature on the motor case may exceed 100 °C (212 °F) depending on operating conditions such as ambient temperature, operating speed, duty cycle and others. To prevent the motor bearings (ball bearings) from reaching its usable life quickly, use the motor in conditions where the surface temperature will not exceed 100 °C (212 °F).

- **Holding torque at standstill**

The motor holding torque is reduced by the current cutback function of the driver at motor standstill. When operating the motor, take account of the motor torque drop at the time of stopping.

## Preparation

### ■ Checking the product

Verify that the items listed below are included. Report any missing or damaged items to the Oriental Motor sales office from which you purchased the product.

- Motor ..... 1 unit
- Connection cable..... 1 pc. [0.6 m (2 ft.)] \*
- Instructions and Precautions for Safe Use..... 1 copy

\* Supplied with the **PKP5□-L** types and the connector coupled type motor and driver packages

### ■ How to identify the product model

Check the model name of the motor against the model name shown on the nameplate.

**PKP5** □ □ □ □ **N** □ □ □ □ □ **-L**  
 1 2 3 4 5 6 7 8 9

1	Motor frame size	<b>2:</b> 28 mm (1.10 in.) <b>4:</b> 42 mm (1.65 in.) <b>6:</b> 56.4 mm (2.22 in.) *
2	Motor length	
3	Motor identification ( <b>PKP56</b> only)	<b>Blank:</b> Motor frame size 56.4 mm (2.22 in.) <b>F:</b> Motor frame size 60 mm (2.36 in.)
4	Motor type	<b>Blank:</b> Standard type <b>M:</b> High-resolution type
5	Motor winding specification	Representative example <b>18:</b> Rated current 1.8 A/phase <b>24:</b> Rated current 2.4 A/phase
6	Shape	<b>A:</b> Single shaft <b>B:</b> Double shaft <b>M:</b> With electromagnetic brake
7	Output shaft diameter	<b>A:</b> Imperial <b>Blank:</b> Metric
8	Motor identification	<b>2:</b> Model A <b>Blank:</b> Model B <b>W:</b> Model C
9	Connection cable	<b>-L:</b> Included with a connection cable <b>Blank:</b> Without connection cable

\* The motor frame size is 60 mm (2.36 in.) when the model name is **PKP56□F**.

### ■ Names of parts

The pin numbers as well as the colors of lead wires are shown in the figures.  
The colors of lead wires show arrangement of colors of our connection cable.

#### ● Motors of Model A (connector type)

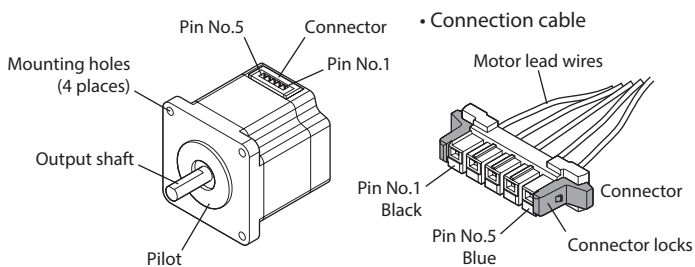

#### Pin assignment

Pin No.	Lead wire color
5	Blue
4	Red
3	Orange
2	Green
1	Black

#### Applicable connector/lead wire

Type	Model
Connector housing	MDF97A-5S-3.5C (HIROSE ELECTRIC CO., LTD.)
Contact	MDF97-22SC (HIROSE ELECTRIC CO., LTD.)
Designated crimping tool	HT801/MDF97-22S (HIROSE ELECTRIC CO., LTD.)
Applicable lead wire	– AWG24 to 22 (0.2 to 0.3 mm <sup>2</sup> ) – Outer sheath diameter: ø1.24 to 1.38 mm (ø0.049 to 0.054 in.) – Stripping length of wire insulation: 1.8 to 2.3 mm (0.071 to 0.091 in.)

#### ● Motors of Model B (connector type)

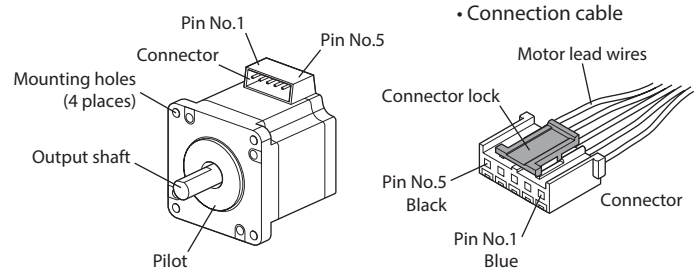

#### Pin assignment

Pin No.	Lead wire color
1	Blue
2	Red
3	Orange
4	Green
5	Black

#### Applicable connector/lead wire

Motor model	Type	Model
<b>PKP52</b>	Connector housing	51065-0500 (Molex Incorporated)
	Contact	50212-8xxx (Molex Incorporated)
	Designated crimping tool	63819-0500 (Molex Incorporated)
	Applicable lead wire	– AWG26 to 24 (0.14 to 0.2 mm <sup>2</sup> ) – Outer sheath diameter: ø1.4 mm (ø0.055 in.) or less – Stripping length of wire insulation: 1.3 to 1.8 mm (0.051 to 0.071 in.)
<b>PKP54</b>	Connector housing	51103-0500 (Molex Incorporated)
	Contact	50351-8xxx (Molex Incorporated)
	Designated crimping tool	63811-8100 (Molex Incorporated)
	Applicable lead wire	– AWG24 to 22 (0.2 to 0.3 mm <sup>2</sup> ) – Outer sheath diameter: ø1.15 to 1.8 mm (ø0.045 to 0.071 in.) – Stripping length of wire insulation: 2.3 to 2.8 mm (0.091 to 0.11 in.)
<b>PKP56</b>	Connector housing	VHR-5N (J.S.T. Mfg. Co., Ltd.)
	Contact	BVH-21T-P1.1 (J.S.T. Mfg. Co., Ltd.)
	Designated crimping tool	AWG22, 20: YC-160R (J.S.T. Mfg. Co., Ltd.) AWG20, 18: YC-161R (J.S.T. Mfg. Co., Ltd.)
	Applicable lead wire	– AWG22 to 18 (0.33 to 0.83 mm <sup>2</sup> ) – Outer sheath diameter: ø1.7 to 3.0 mm (ø0.067 to 0.118 in.) – Stripping length of wire insulation: 3.0 to 3.5 mm (0.118 to 0.138 in.)

## ● Motors of Model C (lead wire type)

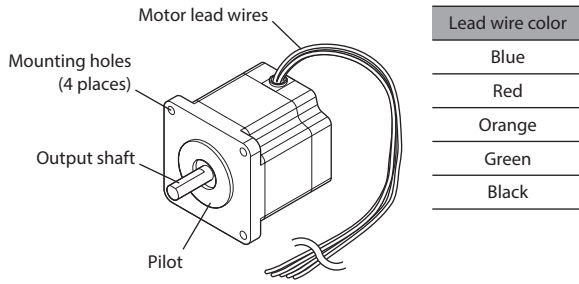

## Connection

### ■ Connector type motor

#### ● When inserting the connector

Hold the connector main body, and insert it in straight securely. Inserting the connector in an inclined state may result in damage to connector or a connection failure.

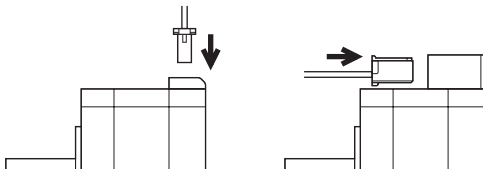

#### ● When pulling out the connector

Pull out the connector in straight while releasing the lock part of the connector. Having the motor lead wires or pulling out the connector in a state of being locked may damage the connector.

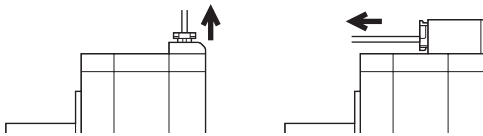

Secure the lead wires at the connection part of the connector to prevent the connector or terminals from receiving stress due to bending or self-weight of lead wires. Also, do not excessively bend the lead wires near the connection part of the connector. Applying stress on the motor lead wires may cause poor contact or disconnection, leading to malfunction or heat generation.

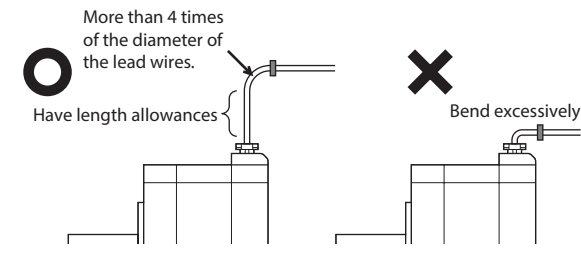

### ■ Connection with the drivers of Oriental Motor

Refer to the following table when connecting with the drivers of Oriental Motor. "Color" in the table shows the colors of lead wires of our connection cable.



The motors of the model A and model B are different in pin assignments. Wrong connection will not cause the motor to operate properly.

#### ● Connection with the CVD Series

Driver CN2 Pin No.	Model A		Model B		Model C
	Pin No.	Color	Pin No.	Color	Color
1	5	Blue	1	Blue	Blue
2	4	Red	2	Red	Red
3	3	Orange	3	Orange	Orange
4	2	Green	4	Green	Green
5	1	Black	5	Black	Black

## Installation

### ■ Location for installation

The motor is designed and manufactured to be incorporated in equipment. Install it in a well-ventilated location that provides easy access for inspection. The location must also satisfy the following conditions:

- Inside an enclosure that is installed indoors (provide vent holes)
- Operating ambient temperature:  $-10$  to  $+50$  °C ( $+14$  to  $+122$  °F) (non-freezing)
- Operating ambient humidity 85 % or less (non-condensing)
- Area free of explosive atmosphere, toxic gas (such as sulfuric gas), or liquid
- Area not exposed to direct sun
- Area free of excessive amount of dust, iron particles or the like
- Area not subject to splashing water (rain, water droplets), oil (oil droplets) or other liquids
- Area free of excessive salt
- Area not subject to continuous vibrations or excessive shocks
- Area free of excessive electromagnetic noise (from welders, power machinery, etc.)
- Area free of radioactive materials, magnetic fields or vacuum
- 1,000 m (3,300 ft.) or lower above sea level

### ■ Installation method

The motor can be installed in any direction.

Install the motor onto an appropriate flat metal plate having excellent vibration resistance and heat conductivity.

When installing the motor, secure it with four bolts (not included) through the four mounting holes provided. Do not leave a gap between the motor and metal plate.

#### ● Installation method 1

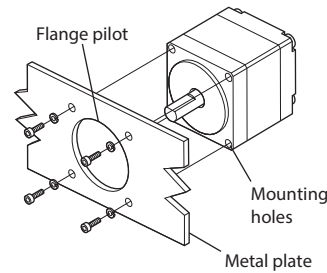

#### ● Installation method 2

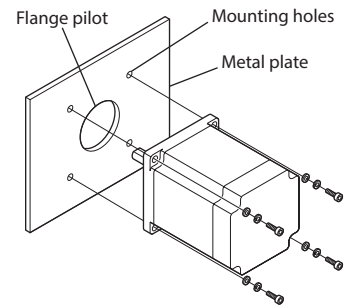

Model	Nominal size	Tightening torque [N·m (oz·in)]	Effective depth of screw thread [mm (in.)]	Installation method
PKP52	M2.5	0.5 (71)	2.5 (0.098)	1
PKP54	M3	1 (142)	4.5 (0.177)	
PKP56	M4	2 (280)	—	2

Values of the tightening torque are recommended. Tighten the screws with a suitable torque according to the design conditions of the metal plate to be installed.

### ■ Installing a load

When connecting a load to the motor, align the centers of the motor output shaft and load shaft. Be careful not to damage the output shaft or bearings when installing a coupling or pulley to the motor output shaft.

### ■ Permissible radial load and permissible axial load

The radial load and axial load on the motor output shaft must be kept the permissible values listed in the table below.

#### ● Motors of Model A

Model	Permissible radial load [N (lb.)]					Permissible axial load [N (lb.)]
	Distance from the tip of motor output shaft					
	0 mm (0 in.)	5 mm (0.20 in.)	10 mm (0.39 in.)	15 mm (0.59 in.)	20 mm (0.79 in.)	
PKP54	35 (7.8)	44 (9.9)	58 (13)	85 (19.1)	—	15 (3.3)
PKP56 *1	61 (13.7)	73 (16.4)	90 (20)	140 (31)	—	30 (6.7)
PKP56 *2	90 (20)	100 (22)	130 (29)	180 (40)	270 (60)	

\*1 Output shaft diameter  $\phi 6.35$  mm ( $\phi 0.25$  in.)

\*2 Output shaft diameter  $\phi 8$  mm ( $\phi 0.31$  in.)

## ● Motors of Model B and C

Model	Permissible radial load [N (lb.)]					Permissible axial load [N (lb.)]
	Distance from the tip of motor output shaft					
	0 mm (0 in.)	5 mm (0.20 in.)	10 mm (0.39 in.)	15 mm (0.59 in.)	20 mm (0.79 in.)	
<b>PKP52</b>	25 (5.6)	34 (7.6)	52 (11.7)	–	–	5 (1.12)
<b>PKP54</b>	20 (4.5)	25 (5.6)	34 (7.6)	52 (11.7)	–	10 (2.2)
<b>PKP56</b>	63 (14.1)	75 (16.8)	95 (21)	130 (29)	190 (42)	20 (4.5)
<b>PKP56□M</b>	90 (20)	100 (22)	130 (29)	180 (40)	270 (60)	

## Maintenance/inspection

### ■ Inspection

It is recommended that periodic inspections are conducted for the items listed below after each operation of the motor. If an abnormal condition is noted, discontinue any use and contact your nearest Oriental Motor sales office.

#### Inspection item

- Check if any of the screws having installed the motor is loose.
- Check if an unusual noise is generated from a bearing part (ball bearings) of the motor.
- Check if a damage or stress is applied on the motor lead wires.
- Check if the connection part with the connector or the driver is loose.
- Check if the motor output shaft and the load shaft are out of alignment.

### ■ Warranty

Check on the Oriental Motor Website for the product warranty.

### ■ Disposal

Dispose the product correctly in accordance with laws and regulations, or instructions of local governments.

## Specifications

Check on the Oriental Motor Website for the product specifications.

## General specifications

Degree of protection	IP20	
Operation environment	Ambient temperature	–10 to +50 °C (+14 to +122 °F) (non-freezing)
	Humidity	85 % or less (non-condensing)
	Altitude	Up to 1,000 m (3,300 ft.) above sea level
	Surrounding atmosphere	No corrosive gas, dust, water or oil
Storage environment, Shipping environment	Ambient temperature	–20 to +60 °C (–4 to +140 °F) (non-freezing)
	Humidity	85 % or less (non-condensing)
	Altitude	Up to 3,000 m (10,000 ft.) above sea level
	Surrounding atmosphere	No corrosive gas, dust, water or oil
Insulation resistance	100 MΩ or more when 500 VDC megger is applied between the case and motor windings.	
Dielectric strength	Sufficient to withstand the following conditions applied between the case and motor windings for 1 minute: <ul style="list-style-type: none"> <li>• <b>PKP52, PKP54:</b> 0.5 kVAC 50/60 Hz</li> <li>• <b>PKP56:</b> 1.5 kVAC 50/60 Hz *</li> </ul>	

\* Motors of Model A: 1.0 kVAC 50/60 Hz

## Regulations and standards

### ■ RoHS Directive

This product does not contain the substances exceeding the restriction values.

- Unauthorized reproduction or copying of all or part of this manual is prohibited.
- Oriental Motor shall not be liable whatsoever for any problems relating to industrial property rights arising from use of any information, circuit, equipment or device provided or referenced in this manual.
- Characteristics, specifications and dimensions are subject to change without notice.
- While we make every effort to offer accurate information in the manual, we welcome your input. Should you find unclear descriptions, errors or omissions, please contact your nearest Oriental Motor sales office.
- **Orientalmotor** is a registered trademark or trademark of Oriental Motor Co., Ltd., in Japan and other countries.

© Copyright ORIENTAL MOTOR CO., LTD. 2013

Published in June 2022

- Please contact your nearest Oriental Motor office for further information.

ORIENTAL MOTOR U.S.A. CORP.  
Technical Support Tel:800-468-3982  
8:30am EST to 5:00pm PST (M-F)  
www.orientalmotor.com

ORIENTAL MOTOR (EUROPA) GmbH  
Schiesstraße 44, 40549 Düsseldorf, Germany  
Technical Support Tel:00 800/22 55 66 22  
www.orientalmotor.de

ORIENTAL MOTOR (UK) LTD.  
Unit 5 Faraday Office Park, Rankine Road,  
Basingstoke, Hampshire RG24 8QB UK  
Tel:+44-1256347090  
www.oriental-motor.co.uk

ORIENTAL MOTOR (FRANCE) SARL  
Tel:+33-1 47 86 97 50  
www.orientalmotor.fr

ORIENTAL MOTOR ITALIA S.r.l.  
Tel:+39-02-93906347  
www.orientalmotor.it

ORIENTAL MOTOR CO., LTD.  
4-8-1 Higashiueno, Taito-ku, Tokyo 110-8536  
Japan  
Tel:+81-3-6744-0361  
www.orientalmotor.co.jp

ORIENTAL MOTOR ASIA PACIFIC PTE. LTD.  
Singapore  
Tel:1800-842-0280  
www.orientalmotor.com.sg

ORIENTAL MOTOR (MALAYSIA) SDN. BHD.  
Tel:1800-806-161  
www.orientalmotor.com.my

ORIENTAL MOTOR (THAILAND) CO., LTD.  
Tel:1800-888-881  
www.orientalmotor.co.th

ORIENTAL MOTOR (INDIA) PVT. LTD.  
Tel:1800-120-1995 (For English)  
1800-121-4149 (For Hindi)  
www.orientalmotor.co.in

TAIWAN ORIENTAL MOTOR CO., LTD.  
Tel:0800-060708  
www.orientalmotor.com.tw

SHANGHAI ORIENTAL MOTOR CO., LTD.  
Tel:400-820-6516  
www.orientalmotor.com.cn

INA ORIENTAL MOTOR CO., LTD.  
Korea  
Tel:080-777-2042  
www.inaom.co.kr