



## OPERATING MANUAL

### 2-Phase Stepping Motor PKP Series CS geared type

#### Introduction

##### Before use

Only qualified personnel of electrical and mechanical engineering should work with the product.

Use the product correctly after thoroughly reading the "Safety precautions." In addition, be sure to observe the contents described in warning, caution, and note in this manual. The product described in this manual is designed and manufactured to be incorporated in general industrial equipment. Do not use for any other purpose. Oriental Motor Co., Ltd. is not responsible for any compensation for damage caused through failure to observe this warning.

#### Safety precautions

The precautions described below are intended to ensure the safe and correct use of the product, and to prevent the customer and others from exposure to the risk of injury. Use the product only after carefully reading and fully understanding these instructions.

##### Description of signs

	Handling the product without observing the instructions that accompany a "WARNING" symbol may result in serious injury or death.
	Handling the product without observing the instructions that accompany a "CAUTION" symbol may result in injury or property damage.
	The items under this heading contain important handling instructions that the user should observe to ensure the safe use of the product.

##### Description of graphic symbols

	Indicates "prohibited" actions that must not be performed.
	Indicates "compulsory" actions that must be performed.

<b>WARNING</b>	
	<ul style="list-style-type: none"> <li>Do not use the product in explosive or corrosive environments, in the presence of flammable gases, in places subjected to splashing water, or near combustibles. Doing so may result in fire or injury.</li> <li>Do not forcibly bend, pull, or pinch the cable. Doing so may result in fire.</li> <li>Do not disassemble or modify the product. Doing so may result in injury.</li> </ul>
	<ul style="list-style-type: none"> <li>Assign qualified personnel to the task of installing, wiring, operating/controlling, inspecting and troubleshooting the product. Handling by unqualified personnel may result in fire or injury.</li> <li>Take measures to keep the moving part in position if the product is used in vertical operations such as elevating equipment. Failure to do so may result in injury or damage to equipment.</li> <li>Install the product inside an enclosure. Failure to do so may result in injury.</li> <li>Connect the cables securely according to the wiring diagram. Failure to do so may result in fire.</li> <li>For the power supply, use a DC power supply with reinforced insulation on its primary and secondary sides. Failure to do so may result in electric shock.</li> </ul>

Thank you for purchasing an Oriental Motor product.

This Operating Manual describes product handling procedures and safety precautions.

- Please read it thoroughly to ensure safe operation.
- Always keep the manual where it is readily available.

#### CAUTION

	<ul style="list-style-type: none"> <li>Do not use the product beyond its specifications. Doing so may result in injury or damage to equipment.</li> <li>Keep your fingers and objects out of the openings in the product. Failure to do so may result in fire or injury.</li> <li>Do not touch the product during operation or immediately after stopping. Doing so may result in a skin burn(s).</li> <li>Do not carry the motor by holding the motor output shaft or cable. Doing so may result in injury.</li> <li>Do not place combustibles around the product. Doing so may result in fire or a skin burn(s).</li> <li>Do not leave anything around the product that would obstruct ventilation. Doing so may result in damage to equipment.</li> <li>Do not touch the rotating part (output shaft) during operation. Doing so may result in injury.</li> </ul>
	<ul style="list-style-type: none"> <li>Provide a cover over the rotating part (output shaft) of the motor. Failure to do so may result in injury.</li> <li>Use the motor and driver only in the specified combination. Failure to do so may result in fire.</li> <li>Provide an emergency stop device or emergency stop circuit external to the equipment so that the entire equipment will operate safely in the event of a system failure or malfunction. Failure to do so may result in injury.</li> <li>When an abnormal condition has occurred, immediately stop operation to turn off the driver power. Failure to do so may result in fire or injury.</li> <li>The motor surface temperature may exceed 70 °C (158 °F) even under normal operating conditions. If the operator is allowed to approach the motor in operation, affix a warning label shown in the figure on a conspicuous position. Failure to do so may result in a skin burn(s).</li> </ul>



Warning label

#### Precautions for use

- **When conducting the insulation resistance measurement or the dielectric strength test, be sure to separate the connection between the motor and the driver.**

Conducting the insulation resistance measurement or dielectric strength test with the motor and driver connected may result in damage to the product.

- **Do not apply a radial load and axial load in excess of the specified permissible limit.**

Continuing to operate the motor under an excessive radial load or axial load may damage the bearings (ball bearings) of the motor. Be sure to operate the motor within the specified permissible limit of radial load and axial load.

- **Motor surface temperature**

The motor surface temperature may exceed 100 °C (212 °F) under certain conditions (operating ambient temperature, operating speed, duty cycle, etc.). To prevent the bearings (ball bearings) of the motor from reaching its usable life quickly, use the motor in conditions where the surface temperature does not exceed 100 °C (212 °F). Also, use in a condition where the surface temperature of the gearhead does not exceed 70 °C (158 °F) in order to prevent deterioration of grease and parts in the gearhead.

- **Grease leakage**

On rare occasions, a small amount of grease may ooze out from the gearhead. If there is concern over possible environmental damage resulting from the leakage of grease, check for grease stains during regular inspections. Alternatively, install an oil pan or other device to prevent leakage from causing further damage. Oil leakage may lead to problems in the customer's equipment or products.

- **Holding torque at standstill**

The motor holding torque is reduced by the current cutback function of the driver at motor standstill. When selecting the motor, take account of the motor torque drop at the time of stopping.

● **Allowable torque**

When operating the motor at a constant speed, use so that the torque does not exceed the allowable torque in the specifications. Operating the motor in excess of the allowable torque may cause damage to the gearhead.

● **Speed range**

Operate the motor within the speed range in the specifications. Operation beyond the speed range may shorten the lifetime of the gearhead.

● **Backlash**

The gearhead output shaft has backlash. To suppress the influence of the backlash, perform positioning operation in either one direction of clockwise or counter-clockwise directions.

● **Rotation direction of the gearhead output shaft**

The gearhead output shaft rotates in the same direction as the motor output shaft.

**Preparation**

■ **Checking the product**

Verify that the items listed below are included. Report any missing or damaged items to the Oriental Motor sales office from which you purchased the product.

- Motor ..... 1 unit
- Parallel key ..... 1 pc. (Included with **PKP26**)
- Motor mounting screw set..... 1 set (Included with **PKP26**)  
 [Packing items] Screw ..... 4 pcs. [M4x60 mm (2.36 in.)]  
 Washer..... 4 pcs.  
 Spring washer..... 4 pcs.
- Instructions and Precautions for Safe Use..... 1 copy

■ **How to identify the product model**

Verify the model name of the purchased product against the model name shown on the nameplate. Refer to "Information about nameplate" for how to identify the nameplate.

**PKP 2 4 3 D 15 A 2 - CS 5**  
 1 2 3 4 5 6 7 8 9 10

1	Series	<b>PKP: PKP Series</b>
2	2-phase	
3	Motor frame size	<b>2:</b> 28 mm (1.10 in.) <b>4:</b> 42 mm (1.65 in.) <b>6:</b> 60 mm (2.36 in.)
4	Motor length	
5	Numbers of lead wire	<b>D:</b> 4 lead wires <b>U:</b> 6 lead wires
6	Motor winding specification	Representative example <b>15:</b> Rated current 1.5 A/phase <b>23:</b> Rated current 2.3 A/phase
7	Shaft shape	<b>A:</b> Single shaft <b>B:</b> Double shaft
8	Motor identification	<b>2:</b> Model A Blank: Model B
9	Type of gear	<b>CS: CS geared</b>
10	Gear ratio	

■ **Information about nameplate**

The figure shows an example.

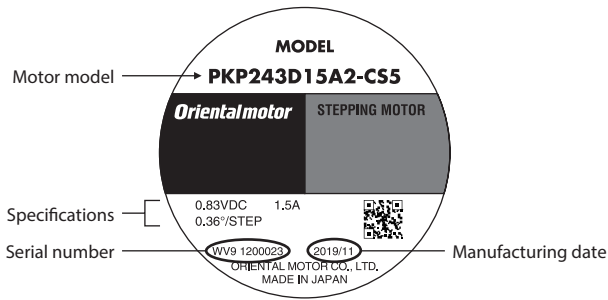

**memo** The position describing the information may vary depending on the product.

■ **Names of parts**

The pin numbers as well as the colors of lead wires are shown in the figures. The connection diagrams show our connection cable.

● **Motors of Model A**

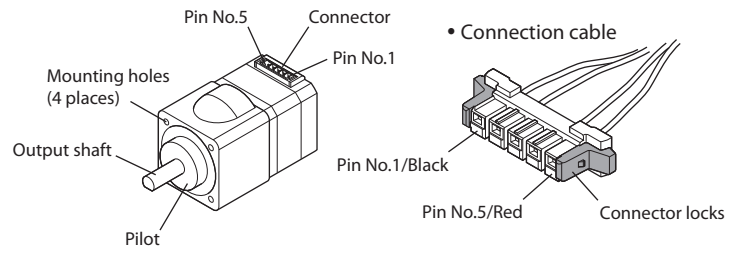

**Wiring connection diagram**

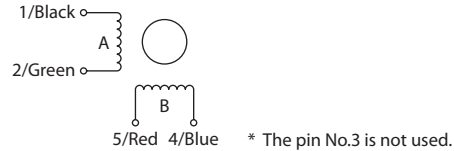

**Applicable connector/lead wire**

Type	Model
Connector housing	MDF97A-5S-3.5C (HIROSE ELECTRIC CO., LTD.)
Contact	MDF97-22SC (HIROSE ELECTRIC CO., LTD.)
Designated crimping tool	HT801/MDF97-22S (HIROSE ELECTRIC CO., LTD.)
Applicable lead wire	<ul style="list-style-type: none"> <li>• AWG24 to 22 (0.2 to 0.3 mm<sup>2</sup>)</li> <li>• Outer sheath diameter: ø1.24 to 1.38 mm (ø0.049 to 0.054 in.)</li> <li>• Stripping length of wire insulation: 1.8 to 2.3 mm (0.071 to 0.091 in.)</li> </ul>

● **Motors of Model B**

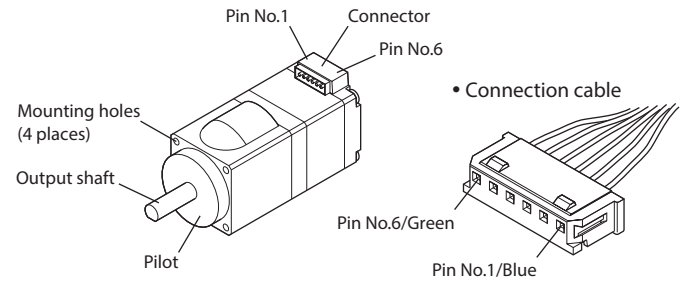

**Wiring connection diagram**

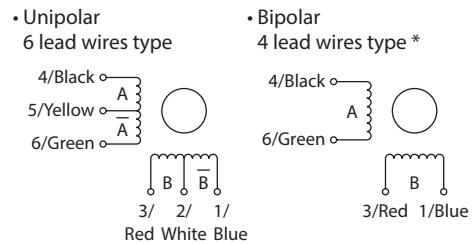

## Applicable connector/lead wire

Type	Model
Connector housing	51065-0600 (Molex Incorporated)
Contact	50212-8XXX (Molex Incorporated)
Designated crimping tool	63819-0500 (Molex Incorporated)
Applicable lead wire	<ul style="list-style-type: none"> <li>When the setting current is less than 1 A/phase: AWG28 to 24 (0.08 to 0.2 mm<sup>2</sup>)</li> <li>When the setting current is 1 A/phase or more: AWG26 to 24 (0.14 to 0.2 mm<sup>2</sup>)</li> <li>When the setting current is 1.5 A/phase or more: AWG24 (0.2 mm<sup>2</sup>)</li> </ul> Outer sheath diameter: ø0.8 to 1.4 mm (ø0.031 to 0.055 in.) Stripping length of wire insulation: 1.3 to 1.8 mm (0.051 to 0.071 in.)

## Connection

### • When inserting the connector

Hold the connector main body, and insert it in straight securely. Inserting the connector in an inclined state may result in damage to connector or a connection failure.

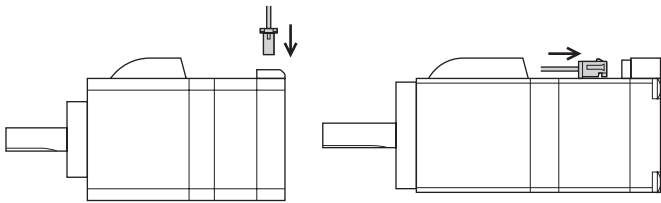

### • When pulling out the connector

Pull out the connector in straight. Having the lead wires or pulling out the connector in a state of being locked may damage the connector.

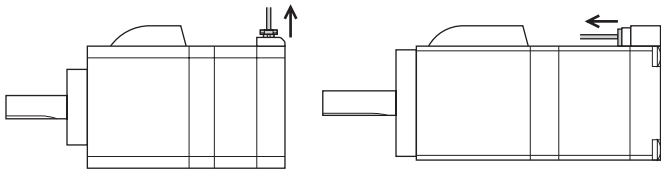

Secure the lead wires of the connection part of the connector to prevent the connector or terminals from receiving stress due to bending or self-weight of lead wires. Also, do not excessively bend the lead wires near the connection part of the connector. Applying stress on the lead wires may cause poor contact or disconnection, leading to malfunction or heat generation.

## ■ Connection with the drivers of Oriental Motor

Refer to the table when connecting with the drivers of Oriental Motor. "Color" in the table shows the colors of lead wires of our connection cable.



The motors of the Model A and Model B are different in pin assignments. The motor does not rotate properly if the connection is wrong.

### • Connection with the CVD Series

Driver CN2 pin number	Model A		Model B	
	Pin number	Color	Pin number	Color
1	4	Blue	1	Blue
2	5	Red	3	Red
3	–	–	–	–
4	2	Green	6	Green
5	1	Black	4	Black

### • Connection with the CMD driver

Driver CN3 pin number	Model B	
	Pin number	Color
1	1	Blue
2	2	White
3	3	Red
4	4	Black
5	5	Yellow
6	6	Green

## Installation

### ■ Installation location

The motor is designed and manufactured to be incorporated in equipment. Install it in a well-ventilated location that provides easy access for inspection. The location must also satisfy the following conditions:

- Inside an enclosure that is installed indoors (provide vent holes)
- Operating ambient temperature –10 to +50 °C (+14 to +122 °F) (non-freezing)
- Operating ambient humidity 85 % or less (non-condensing)
- Area free of explosive atmosphere, toxic gas (such as sulfuric gas), or liquid
- Area not exposed to direct sun
- Area free of excessive amount of dust, iron particles or the like
- Area not subject to splashing water (rain, water droplets), oil (oil droplets) or other liquids
- Area free of excessive salt
- Area not subject to continuous vibrations or excessive shocks
- Area free of excessive electromagnetic noise (from welders, power machinery, etc.)
- Area free of radioactive materials, magnetic fields or vacuum
- Up to 1,000 m (3,300 ft.) above sea level

### ■ Installation method

Install the motor onto an appropriate flat metal plate having excellent vibration resistance and heat conductivity.

When installing the motor, use four mounting holes and secure the motor with four screws so that no gap remains between the motor and the metal plate. A mounting screw set is included in the **PKP26**.

#### • PKP22, PKP24

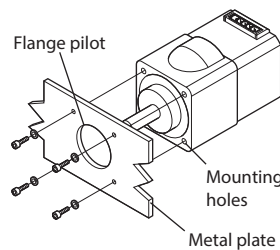

#### • PKP26

Secure the motor using the included mounting screw set. [Screw size: M4x60 mm (2.36 in.)]

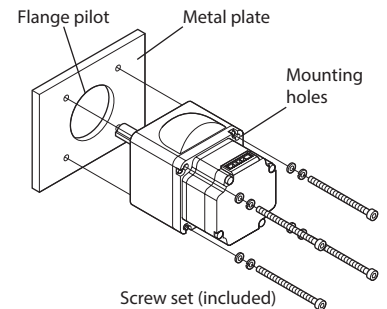

Model	Nominal size	Tightening torque [N·m (oz·in)]	Effective depth of screw thread [mm (in.)]
<b>PKP22</b>	M3	1 (142)	6 (0.24)
<b>PKP24</b>	M4	2 (280)	8 (0.31)
<b>PKP26</b>	M4	2 (280)	–

Values of the tightening torque are recommended. Tighten the screws with a suitable torque according to the design conditions of the metal plate to be installed.



Do not loosen the gearhead assembling screws (four pieces).

### ■ Installing a load

When installing a load to the motor, align the centers of the motor output shaft and load shaft. When installing a coupling or pulley on the motor output shaft, do so without damaging the output shaft and bearings.

## ■ Permissible radial load and permissible axial load

The radial load and the axial load applied to the motor output shaft must not exceed the permissible values in the table.

Model	Permissible radial load [N (lb.)]				
	Distance from the tip of motor output shaft				
	0 mm (0 in.)	5 mm (0.2 in.)	10 mm (0.39 in.)	15 mm (0.59 in.)	20 mm (0.79 in.)
<b>PKP22</b>	30 (6.7)	37 (8.3)	50 (11.2)	73 (16.4)	–
<b>PKP24</b>	59 (13.2)	68 (15.3)	80 (18)	96 (21)	–
<b>PKP26</b>	160 (36)	170 (38)	200 (45)	220 (49)	260 (58)

Model	Permissible axial load [N (lb.)]
<b>PKP22</b>	30 (6.7)
<b>PKP24</b>	40 (9)
<b>PKP26</b>	70 (15.7)

## Inspection and maintenance

### ■ Inspection

It is recommended that periodic inspections would be conducted for the items listed below after each operation of the motor. If an abnormal condition is noted, discontinue any use and contact your nearest Oriental Motor sales office.

#### Inspection item

- Check if any of the screws having installed the motor is loose.
- Check if an unusual noise is generated from a bearing part (ball bearings) of the motor.
- Check if a damage or stress is applied on the cable.
- Check if the connection part with the connector or the driver is loose.
- Check if the motor output shaft and the load shaft are out of alignment.

### ■ Warranty

Check on the Oriental Motor Website for the product warranty.

### ■ Disposal

Dispose the product correctly in accordance with laws and regulations, or instructions of local governments.

## Specifications

Check on the Oriental Motor Website for the product specifications.

### General specifications

Degree of protection	IP20	
Operation environment	Ambient temperature	–10 to +50 °C (+14 to +122 °F) (non-freezing)
	Humidity	85 % or less (non-condensing)
	Altitude	Up to 1,000 m (3,300 ft.) above sea level
	Surrounding atmosphere	No corrosive gas, dust, water or oil
Storage environment Shipping environment	Ambient temperature	–20 to +60 °C (–4 to +140 °F) (non-freezing)
	Humidity	85 % or less (non-condensing)
	Altitude	Up to 3,000 m (10,000 ft.) above sea level
	Surrounding atmosphere	No corrosive gas, dust, water or oil
Insulation resistance	100 MΩ or more when 500 VDC megger is applied between the windings and the case.	
Dielectric strength	Sufficient to withstand the following conditions applied between the windings and the case for 1 minute. <ul style="list-style-type: none"> <li>• <b>PKP22, PKP24:</b> 0.5 kVAC 50/60 Hz</li> <li>• <b>PKP26:</b> 1.0 kVAC 50/60 Hz</li> </ul>	

## Regulations and standards

### ■ RoHS Directive

This product does not contain the substances exceeding the restriction values.

- Unauthorized reproduction or copying of all or part of this manual is prohibited.
- Oriental Motor shall not be liable whatsoever for any problems relating to industrial property rights arising from use of any information, circuit, equipment or device provided or referenced in this manual.
- Characteristics, specifications and dimensions are subject to change without notice.
- While we make every effort to offer accurate information in the manual, we welcome your input. Should you find unclear descriptions, errors or omissions, please contact your nearest Oriental Motor sales office.
- **Orientalmotor** is a registered trademark or trademark of Oriental Motor Co., Ltd., in Japan and other countries.

© Copyright ORIENTAL MOTOR CO., LTD. 2020

Published in July 2022

- Please contact your nearest Oriental Motor office for further information.

ORIENTAL MOTOR U.S.A. CORP.  
 Technical Support Tel:800-468-3982  
 8:30am EST to 5:00pm PST (M-F)  
[www.orientalmotor.com](http://www.orientalmotor.com)

ORIENTAL MOTOR (EUROPA) GmbH  
 Schiessstraße 44, 40549 Düsseldorf, Germany  
 Technical Support Tel:00 800/22 55 66 22  
[www.orientalmotor.de](http://www.orientalmotor.de)

ORIENTAL MOTOR (UK) LTD.  
 Unit 5 Faraday Office Park, Rankine Road,  
 Basingstoke, Hampshire RG24 8QB UK  
 Tel:+44-1256347090  
[www.orientalmotor.co.uk](http://www.orientalmotor.co.uk)

ORIENTAL MOTOR (FRANCE) SARL  
 Tel:+33-1 47 86 97 50  
[www.orientalmotor.fr](http://www.orientalmotor.fr)

ORIENTAL MOTOR ITALIA S.r.l.  
 Tel:+39-02-93906347  
[www.orientalmotor.it](http://www.orientalmotor.it)

ORIENTAL MOTOR CO., LTD.  
 4-8-1 Higashiueno, Taito-ku, Tokyo 110-8536  
 Japan  
 Tel:+81-3-6744-0361  
[www.orientalmotor.co.jp](http://www.orientalmotor.co.jp)

ORIENTAL MOTOR ASIA PACIFIC PTE. LTD.  
 Singapore  
 Tel:1800-842-0280  
[www.orientalmotor.com.sg](http://www.orientalmotor.com.sg)

ORIENTAL MOTOR (MALAYSIA) SDN. BHD.  
 Tel:1800-806-161  
[www.orientalmotor.com.my](http://www.orientalmotor.com.my)

ORIENTAL MOTOR (THAILAND) CO., LTD.  
 Tel:1800-888-881  
[www.orientalmotor.co.th](http://www.orientalmotor.co.th)

ORIENTAL MOTOR (INDIA) PVT. LTD.  
 Tel:1800-120-1995 (For English)  
 1800-121-4149 (For Hindi)  
[www.orientalmotor.co.in](http://www.orientalmotor.co.in)

TAIWAN ORIENTAL MOTOR CO., LTD.  
 Tel:0800-060708  
[www.orientalmotor.com.tw](http://www.orientalmotor.com.tw)

SHANGHAI ORIENTAL MOTOR CO., LTD.  
 Tel:400-820-6516  
[www.orientalmotor.com.cn](http://www.orientalmotor.com.cn)

INA ORIENTAL MOTOR CO., LTD.  
 Korea  
 Tel:080-777-2042  
[www.inaom.co.kr](http://www.inaom.co.kr)