



OPERATING MANUAL

Tuning-free AC servo motor

NX Series Driver Edition



Thank you for purchasing an Oriental Motor product. This Operating Manual describes product handling procedures and safety precautions.

- Please read it thoroughly to ensure safe operation.
- Always keep the manual where it is readily available.

Introduction

■ Before use

Only qualified personnel of electrical and mechanical engineering should work with the product.

Use the product correctly after thoroughly reading the section "Safety precautions" on p.2. In addition, be sure to observe the contents described in warning, caution, and note in this manual.

The product described in this manual is designed and manufactured to be incorporated in general industrial equipment. Do not use for any other purpose. Oriental Motor Co., Ltd. is not responsible for any compensation for damage caused through failure to observe this warning.

■ Related operating manuals

For operating manuals not included with the product, contact your nearest Oriental Motor sales office or download from Oriental Motor Website Download Page.

Operating manual name	Included or not included with product
NX Series OPERATING MANUAL Motor Edition	Included
NX Series OPERATING MANUAL Driver Edition (this document)	Included
NX Series USER MANUAL	Not included

Regulations and standards

■ UL Standard and CSA Standard

This product is recognized by UL under the UL and CSA Standards.

● Applicable Standards

Certification Body	Standards File No.
UL	E171462

● WARNING FOR UL MARKING ON DRIVER

- For UL Standard (UL 61800-5-1), the product is recognized for the condition of Maximum Surrounding Air Temperature 50 °C (122 °F).
- Suitable For Use On A Circuit Capable Of Delivering Not More Than 5,000 A rms Symmetrical Amperes, 120 Volts or 240 Volts Maximum.
- Integral solid state short circuit protection does not provide branch circuit protection. Branch circuit protection must be provided in accordance with the National Electric Code and any additional local codes.
- Is used UL Listed Inverse Time Circuit Breaker rated 240 Vac, 15 A.
- Solid State motor overload protection is provided in each model. (NXD20-A/C)
- Solid State motor overload protection reacts at 150 % FLA or less. (NXD75-S)
- Drives have no provision for motor over temperature protection. Motor over temperature protection is required at end application.
- Do not touch the connection terminals on the driver while the power is supplied or for at least 10 minutes after turning off the power. Doing so may result in electric shock.

■ EU Directives

● CE Marking

This product is affixed the CE Marking under the Low Voltage Directive and EMC Directive.

● Low Voltage Directive

Installation conditions (EN Standard)	To be incorporated in equipment.
	Overvoltage category: II
	Pollution degree: 2
	Protection against electric shock: Class I

- This product cannot be used in IT power distribution systems.
- Install the product within the enclosure in order to avoid contact with hands.
- Be sure to maintain a protective ground in case hands should make contact with the product.
Be sure to connect the Protective Earth wire of the cable for motor to the Protective Earth Terminal on the driver, and ground the driver's Protective Earth Terminal.
- To protect against electric shock using an earth leakage breaker (RCD), connect a type B earth leakage breaker to the primary side of the driver.
- When using a circuit breaker (MCCB), use a product conforming to EN Standards or IEC Standards.
- Isolate the motor cable, power-supply cable and other drive cables from the signal cables (CN1, CN4 to CN7) by means of double insulation.

● EMC Directive

This product is conducted EMC testing under the conditions specified in "Example of installation and wiring" on the USER MANUAL. The conformance of your mechanical equipment with the EMC Directive will vary depending on such factors as the configuration, wiring, and layout for other control system devices and electrical parts used with this product. It therefore must be verified through conducting EMC measures in a state where all parts including this product have been installed in the equipment.





This equipment is not intended for use in residential environments nor for use on a low-voltage public network supplied in residential premises, and it may not provide adequate protection to radio reception interference in such environments.

■ RoHS Directive

The products do not contain the substances exceeding the restriction values of RoHS Directive (2011/65/EU).



Safety precautions

The precautions described below are intended to ensure the safe and correct use of the product, and to prevent the customer and others from exposure to the risk of injury. Use the product only after carefully reading and fully understanding these instructions.

 WARNING	Handling the product without observing the instructions that accompany a "WARNING" symbol may result in serious injury or death.
 CAUTION	Handling the product without observing the instructions that accompany a "CAUTION" symbol may result in injury or property damage.
 Note	The items under this heading contain important handling instructions that the user should observe to ensure the safe use of the product.

WARNING

General

- Do not use the product in explosive or corrosive environments, in the presence of flammable gases, in places subjected to splashing water, or near combustibles. Doing so may result in fire, electric shock, or injury.
- Assign qualified personnel to the task of installing, wiring, operating/controlling, inspecting and troubleshooting the product. Failure to do so may result in fire, electric shock, or injury.
- Do not transport, install, connect, or inspect the product while the power is supplied. Always turn the power off before carrying out these operations. Failure to do so may result in electric shock.
- The terminals on the driver's front panel marked with   symbol indicate the presence of high voltage. Do not touch these terminals while the power is on to avoid the risk of fire or electric shock.
- When an alarm is generated in the driver (any of the driver's protective functions is triggered), take measures to hold the moving part in a specific position since the motor stops and loses its holding torque. Failure to do so may result in injury or damage to equipment.
- When an alarm is generated in the driver (any of the driver's protective functions is triggered), remove the cause before clearing the alarm (protective function). Continuing the operation without removing the cause of the problem may cause malfunction of the motor and driver, leading to injury or damage to equipment.

Installation

- The driver is Class I equipment. When installing the driver, install it inside an enclosure so that it is out of the direct reach of users. Be sure to ground if users can touch it. Failure to do so may result in electric shock.
- Install the driver inside an enclosure. Failure to do so may result in electric shock or injury.

Connection

- Always keep the power supply voltage of the driver within the specified range. Failure to do so may result in fire or electric shock.
- Connect the cables securely according to the wiring diagram. Failure to do so may result in fire or electric shock.
- Do not forcibly bend, pull, or pinch the cable. Doing so may result in fire or electric shock.

Operation

- Turn off the driver power supply in the event of a power failure. Otherwise, the motor may suddenly start when the power is restored, causing injury or damage to equipment.
- Do not remove the motor excitation during operation. Doing so may cause the motor to stop and lose the holding force, resulting in injury or damage to equipment.

Maintenance and inspection

- Do not touch the connection terminals on the driver while the power is supplied or for at least 10 minutes after turning off the power. Turn off the power to check the CHARGE LED being turned off before starting connection or inspection. Failure to do so may result in electric shock.

Repair, disassembly and modification

- Do not disassemble or modify the driver. This may cause electric shock or injury. Refer all such internal inspections and repairs to the Oriental Motor sales office from which you purchased the product.

CAUTION

General

- Do not use the driver beyond its specifications. Doing so may result in electric shock, injury, or damage to equipment.
- Keep your fingers and objects out of the openings in the driver. Failure to do so may result in fire, electric shock, or injury.
- Do not touch the driver during operation or immediately after stopping. The surface is hot, and this may cause a skin burn(s).

Installation

- Do not leave anything around the driver that would obstruct ventilation. Doing so may result in damage to equipment.

Connection

- The data edit connector (CN4) and the analog I/O connector (CN6) on the driver are not electrically insulated. When grounding the positive terminal of the power supply, do not connect any equipment (PC, etc.) whose negative terminal is grounded. Doing so may cause the driver and these equipment to short, damaging both.

Operation

- Provide an emergency-stop device or emergency-stop circuit external to the equipment so that the entire equipment will operate safely in the event of a system failure or malfunction. Failure to do so may result in injury.
- Before supplying power to the driver, turn all input signals to the driver to OFF. Otherwise, the motor may suddenly start when the power is turned on, leading to injury or damage to equipment.
- When moving the moving part manually, put the motor into a non-excitation state. Continuing the work while the motor is in an excitation state may result in injury.
- Use a 24 VDC power supply that has been given reinforced insulation between the primary side and secondary side. Failure to do so may cause electric shock.
- Immediately when a problem occurred, stop operation and turn off the driver power supply. Failure to do so may result in fire, electric shock, or injury.
- To prevent electric shock, use only an insulated screwdriver to adjust the driver's switches.

Maintenance and inspection

- Do not touch the terminals while conducting the insulation resistance measurement or the dielectric strength test. Doing so may cause electric shock.

Disposal

- Dispose the product correctly in accordance with laws and regulations, or instructions of local governments.

Precautions for use

- **Be sure to use our cable to connect the motor and the driver.**

If a flexible cable or cable longer than 3 m (9.8 ft.) is to be used, be sure to purchase our cable separately. Check on the Oriental Motor Website for the model name of cables.

- **When conducting the insulation resistance measurement or the dielectric strength test, be sure to separate the connection between the motor and the driver.**

Conducting the insulation resistance measurement or the dielectric strength test with the motor and the driver connected may result in damage to the product.

- **Noise elimination measures**

Refer to the [USER MANUAL](#) for noise elimination measures.

- **Saving data to the non-volatile memory**

Do not turn off the main power supply or 24 VDC power supply while writing the data to the non-volatile memory, and also do not turn off for 5 seconds after the completion of writing the data. Doing so may abort writing the data and cause an EEPROM error alarm to generate. The non-volatile memory can be rewritten approximately 100,000 times.

- **Preventing leakage current**

Stray capacitance exists between the driver's current-carrying line and other current-carrying lines, the earth and the motor, respectively. A high-frequency current may leak out through such capacitance, having a detrimental effect on the surrounding equipment. The actual leakage current depends on the driver's switching frequency, the length of wiring between the driver and motor, and so on.

When providing a leakage current breaker, use the following products, for example, which have high-frequency signal protection:
Mitsubishi Electric Corporation: NV series

- **Motor excitation at power ON**

When the driver has been set to lock the servo after the motor stops in the position control mode or speed control mode: Turning on the power supply will not excite the motor. To excite the motor, you must turn the S-ON input ON.

You can set the motor to be excited automatically after the power has been turned on, by changing the applicable driver parameter using the support software **MEXE02** or the data setter **OPX-2A**.

- **If vertical drive (gravitational operation) such as elevator applications is performed or if sudden start-stop operation of a large inertial load is repeated frequently, connect our regeneration resistor.**

The factory setting is to use the internal regeneration resistor. Note, however, that the internal regeneration resistor does not support continuous regenerative operation, gravitational operation or other operations involving up/down movements, or frequent repeating of sudden starting/stopping of a large inertial load. If any of these operations must be performed, use our regeneration resistor. Check on the Oriental Motor Website for the model name.

- **Note on connecting a power supply whose positive terminal is grounded**

The data edit connector (CN4) and the analog I/O connector (CN6) on the driver are not electrically insulated. When grounding the positive terminal of the power supply, do not connect any equipment (PC, etc.) whose negative terminal is grounded. Doing so may cause the driver and these equipment to short, damaging both. Use the **OPX-2A** to set data, etc.

Preparation

■ Checking the product

Verify that the items listed below are included. Report any missing or damaged items to the Oriental Motor sales office from which you purchased the product.

- Driver..... 1 unit
- CN1 connector (6 pins)..... 1 pc.
- CN2 connector (3 pins)..... 1 pc.
- CN3 connector (7 pins)..... 1 pc.
- CN7 connector (36 pins)..... 1 pc.
- Connector wiring lever (for CN2, CN3)..... 1 pc.
- OPERATING MANUAL Driver Edition (this document)..... 1 copy

Included connector model

The CN2 connector and the CN3 connector are made by either of two manufacturers, WAGO Corporation and Molex Incorporated.

The CN7 connector is made by either of two manufacturers, 3M Company and Molex Incorporated.

About each connector (CN2, CN3, CN7), either one of two connectors is included with a product. Check the manufacturer name with the connector case.

Type	Model number (Manufacturer)
CN1 connector	MC1,5/6-STF-3,5 (PHOENIX CONTACT GmbH & Co. KG)
CN2 connector	721-203 (WAGO Corporation)
	or 54928-0370 (Molex Incorporated)
CN3 connector	721-207 (WAGO Corporation)
	or 54928-0770 (Molex Incorporated)
CN7 connector	Case: 10336-52A0-008 (3M Company) Connector: 10136-3000PE (3M Company)
	or Case: 54331-1361 (Molex Incorporated) Connector: 54306-3619 (Molex Incorporated)

■ Combinations of motors and drivers

The box (□) in the model name indicates the cable length.

The box (◆) in the model name indicates the gear ratio.

● Standard type

Model	Motor model	Driver model
NX45AA-□	NXM45A	NXD20-A
NX45AC-□		NXD20-C
NX410AA-□	NXM410A	NXD20-A
NX410AC-□		NXD20-C
NX620AA-□	NXM620A	NXD20-A
NX620AC-□		NXD20-C
NX640AS-□	NXM640A	NXD75-S
NX975AS-□	NXM975A	

● Standard type with electromagnetic brake

Model	Motor model	Driver model
NX45MA-□	NXM45M	NXD20-A
NX45MC-□		NXD20-C
NX410MA-□	NXM410M	NXD20-A
NX410MC-□		NXD20-C
NX620MA-□	NXM620M	NXD20-A
NX620MC-□		NXD20-C
NX640MS-□	NXM640M	NXD75-S
NX975MS-□	NXM975M	

● **PS geared type**

Model	Motor model	Driver model
NX65AA-PS ◆-□	NXM65A-PS◆	NXD20-A
NX65AC-PS ◆-□		NXD20-C
NX610AA-PS ◆-□	NXM610A-PS◆	NXD20-A
NX610AC-PS ◆-□		NXD20-C
NX920AA-PS ◆-□	NXM920A-PS◆	NXD20-A
NX920AC-PS ◆-□		NXD20-C
NX940AS-PS ◆-□	NXM940A-PS◆	NXD75-S

● **PS geared type with electromagnetic brake**

Model	Motor model	Driver model
NX65MA-PS ◆-□	NXM65M-PS◆	NXD20-A
NX65MC-PS ◆-□		NXD20-C
NX610MA-PS ◆-□	NXM610M-PS◆	NXD20-A
NX610MC-PS ◆-□		NXD20-C
NX920MA-PS ◆-□	NXM920M-PS◆	NXD20-A
NX920MC-PS ◆-□		NXD20-C
NX940MS-PS ◆-□	NXM940M-PS◆	NXD75-S

● **PJ geared type**

Model	Motor model	Driver model
NX810AA-J ◆-□	NXM810A-J◆	NXD20-A
NX810AC-J ◆-□		NXD20-C
NX820AA-J ◆-□	NXM820A-J◆	NXD20-A
NX820AC-J ◆-□		NXD20-C
NX1040AS-J ◆-□	NXM1040A-J◆	NXD75-S
NX1075AS-J ◆-□	NXM1075A-J◆	

● **PJ geared type with electromagnetic brake**

Model	Motor model	Driver model
NX810MA-J ◆-□	NXM810M-J◆	NXD20-A
NX810MC-J ◆-□		NXD20-C
NX820MA-J ◆-□	NXM820M-J◆	NXD20-A
NX820MC-J ◆-□		NXD20-C
NX1040MS-J ◆-□	NXM1040M-J◆	NXD75-S
NX1075MS-J ◆-□	NXM1075M-J◆	

Input/output power ratings

- The box (■) in the model name indicates **A** (single shaft) or **M** (with electromagnetic brake).
- The box (□) in the model name indicates the cable length.
- The box (◆) in the model name indicates the gear ratio.
- The motor model (UL recognized) apply to the condition before a gearhead is assembled.

Model	Motor model	Motor model (UL recognized)	Driver model	Input			Output			
				Voltage	Frequency	Current	Voltage	Frequency	Current	Output
NX45■A-□	NXM45■	NXM45■	NXD20-A	Single-phase 100-115 V	50/60 Hz	1.9 A	Three-phase 0-119 V	0-150 Hz	0.91 A	50 W
NX45■C-□			NXD20-C			Single-phase/ Three-phase 200-230 V				
NX410■A-□	NXM410■	NXM410■	NXD20-A	Single-phase 100-115 V		2.9 A	Three-phase 0-144 V	1.12 A	100 W	
NX410■C-□			NXD20-C	Single-phase/ Three-phase 200-230 V		1.8 A/ 1.0 A				
NX65■A-PS◆-□	NXM65■-PS◆	NXM45■	NXD20-A	Single-phase 100-115 V		1.9 A	Three-phase 0-119 V	0.91 A	50 W	
NX65■C-PS◆-□			NXD20-C	Single-phase/ Three-phase 200-230 V		1.2 A/ 0.7 A				
NX610■A-PS◆-□	NXM610■-PS◆	NXM410■	NXD20-A	Single-phase 100-115 V		2.9 A	Three-phase 0-144 V	1.12 A	100 W	
NX610■C-PS◆-□			NXD20-C	Single-phase/ Three-phase 200-230 V		1.8 A/ 1.0 A				
NX620■A-□	NXM620■	NXM620■	NXD20-A	Single-phase 100-115 V		4.6 A	Three-phase 0-152 V	1.8 A	200 W	
NX620■C-□			NXD20-C	Single-phase/ Three-phase 200-230 V		2.8 A/ 1.6 A				
NX640■S-□	NXM640■	NXM640■	NXD75-S	Three-phase 200-230 V	2.8 A	Three-phase 0-162 V	3.2 A	400 W		
NX810■A-J◆-□	NXM810■-J◆	NXM610■-J	NXD20-A	Single-phase 100-115 V	2.8 A	Three-phase 0-141 V	1.1 A	100 W		
NX810■C-J◆-□			NXD20-C	Single-phase/ Three-phase 200-230 V	1.8 A/ 1.0 A					
NX820■A-J◆-□	NXM820■-J◆	NXM620■-J	NXD20-A	Single-phase 100-115 V	4.6 A	Three-phase 0-152 V	1.8 A	200 W		
NX820■C-J◆-□			NXD20-C	Single-phase/ Three-phase 200-230 V	2.8 A/ 1.6 A					
NX920■A-PS◆-□	NXM920■-PS◆	NXM620■	NXD20-A	Single-phase 100-115 V	4.6 A	Three-phase 0-152 V	1.8 A	200 W		
NX920■C-PS◆-□			NXD20-C	Single-phase/ Three-phase 200-230 V	2.8 A/ 1.6 A					
NX940■S-PS◆-□	NXM940■-PS◆	NXM640■	NXD75-S	Three-phase 200-230 V	2.8 A	Three-phase 0-162 V	3.2 A	400 W		
NX975■S-□	NXM975■	NXM975■			4.7 A	Three-phase 0-160 V	5.9 A	750 W		
NX1040■S-J◆-□	NXM1040■-J◆	NXM940■-J			2.9 A	Three-phase 0-127 V	5.1 A	400 W		
NX1075■S-J◆-□	NXM1075■-J◆	NXM975■-J			4.7 A	Three-phase 0-160 V	5.9 A	750 W		

Names and functions of parts (Example: NXD20-C)

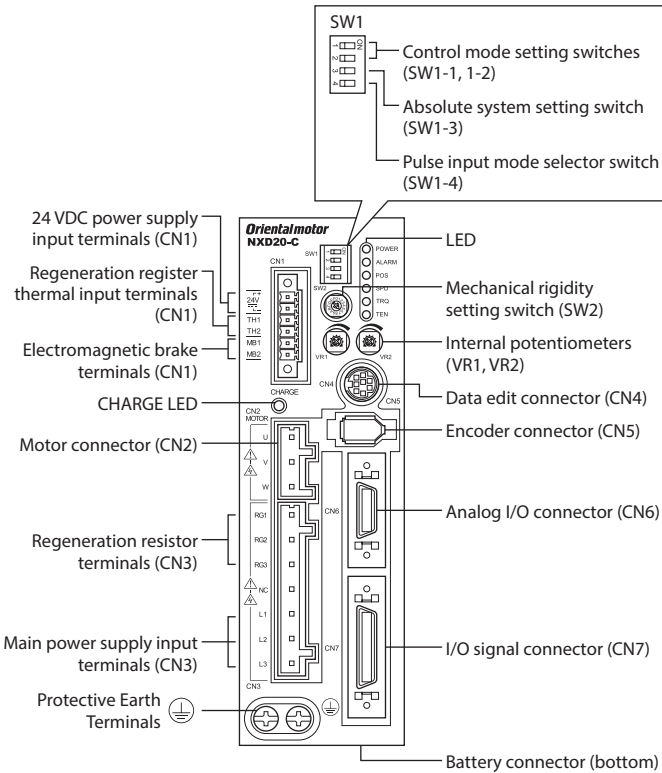

Name	Description
Control mode setting switches (SW1-1, 1-2)	These switches are used to set the control mode of the driver (position control, speed control, torque control or tension control).
Absolute system setting switch (SW1-3)	This switch is effective in the position control mode. Set the switch when the absolute function of the driver is used by connecting our battery BAT01A . ON: Enable the absolute function OFF: Disable the absolute function The factory setting is "OFF".
Pulse input mode selector switch (SW1-4)	In the position control mode, this switch toggles the driver between the 1-pulse input mode and 2-pulse input mode according to the pulse output mode of the controller. ON: 1-pulse input mode, negative logic OFF: 2-pulse input mode, negative logic The factory setting depends on the destination country.
LED	These LEDs indicate the status of the driver. POWER (green): This LED is lit while the main power supply or 24 VDC power supply is input. ALARM (red): This LED will blink when an alarm generates (a protective function is triggered). POS (green): This LED is lit in the position control mode. SPD (green): This LED is lit in the speed control mode. TRQ (green): This LED is lit in the torque control mode. TEN (green): This LED is lit in the tension control mode.
Mechanical rigidity setting switch (SW2)	<ul style="list-style-type: none"> Position control mode or speed control mode This switch sets the gain adjustment level according to the mechanical rigidity. The factory setting is "6." Torque control mode Not used. Tension control mode This switch sets the minimum speed in the simple mode. The factory setting is "6." The switch is not used in high function mode I or high function mode II.

Name	Description
Internal potentiometers (VR1, VR2)	<ul style="list-style-type: none"> Position control mode VR1: This potentiometer sets the damping control frequency. VR2: Not used. Speed control mode VR1: This potentiometer sets the speed command value. VR2: This potentiometer sets the acceleration/ deceleration time. Torque control mode VR1: This potentiometer sets the torque command value. VR2: This potentiometer sets the speed limit. Tension control mode VR1: This potentiometer sets the tension command value. VR2: This potentiometer sets the speed limit.
Data edit connector (CN4)	Connects a PC in which the MEXE02 has been installed, or the OPX-2A .
Encoder connector (CN5)	Connects the motor encoder via a cable for encoder.
Analog I/O connector (CN6)	Connects the analog I/O signals.
I/O signal connector (CN7)	Connects the I/O signals of the controller.
24 VDC power supply input terminals (CN1) [24V]	Connects a 24 VDC power supply. Once a 24 VDC power supply is connected, you can check the contents of alarms that have generated even when the main power supply is cut off. When an electromagnetic brake motor is used, be sure to connect a 24 VDC power supply for the electromagnetic brake.
Regeneration resistor thermal input terminals (CN1) [TH1, TH2]	Connects our regeneration resistor. If no regeneration resistor is connected, insert the CN1 connector to short the TH1 and TH2 terminals.
Electromagnetic brake terminals (CN1) [MB1, MB2]	Connects the cable for electromagnetic brake (24 VDC). MB1: Electromagnetic brake – (black) MB2: Electromagnetic brake + (white)
CHARGE LED (red)	This LED is lit while the main power supply is input. After the main power supply has been turned off, the LED will turn off once the residual voltage in the driver drops to a safe level.
Motor connector (CN2)	Connects the motor. Phase U: Red Phase V: White Phase W: Black
Regeneration resistor terminals (CN3) [RG1, RG3]	When using the internal regeneration resistor, short the RG2 and RG3 terminals using a jumper wire included with the CN3 connector. If our regeneration resistor is used, remove the jumper wire which has shorted the RG2 and RG3 terminals, and connect the lead wires to the RG1 and RG3 terminals.
Main power supply input terminals (CN3)	<ul style="list-style-type: none"> Single-phase 100-115 VAC L, N: Connects single-phase 100-115 VAC. Single-phase 200-230 VAC L1, L2: Connects single-phase 200-230 VAC. L3: Not used. Three-phase 200-230 VAC L1, L2, L3: Connects three-phase 200-230 VAC. NC: Not used.
Protective Earth Terminals	Ground this terminal using a grounding wire of AWG16 (1.25 mm ²) or larger.
Battery connector	Connects our battery BAT01A when using the absolute function of the driver in the position control mode.

Installation

Installation location

The driver is designed and manufactured to be incorporated in equipment. Install it in a well-ventilated location that provides easy access for inspection. The location must also satisfy the following conditions:

- Inside an enclosure that is installed indoors (provide vent holes)
- Operating ambient temperature 0 to +50 °C (+32 to +122 °F) (non-freezing)
- Operating ambient humidity 85 % or less (non-condensing)
- Area free of explosive atmosphere or toxic gas (such as sulfuric gas) or liquid
- Area not exposed to direct sun
- Area free of excessive amount of dust, iron particles or the like
- Area not subject to splashing water (rain, water droplets), oil (oil droplets), or other liquids
- Area free of excessive salt
- Area not subject to continuous vibrations or excessive shocks
- Area free of excessive electromagnetic noise (from welders, power machinery, etc.)
- Area free of radioactive materials, magnetic fields or vacuum
- 1,000 m (3,300 ft.) or lower above sea level

Installation direction

The driver is designed so that heat is dissipated via air convection and conduction through the enclosure. When two or more drivers are to be installed side by side, provide 20 mm (0.79 in.) and 50 mm (1.97 in.) clearances in the horizontal and vertical directions, respectively. When installing the driver inside an enclosure, use two screws (three screws for NXD75-S) to secure the driver through the mounting holes. Screws (M4) are not included. Please provide separately.

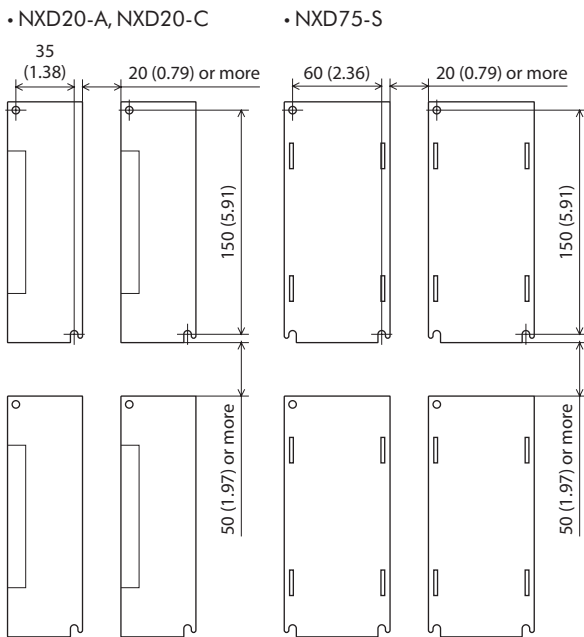

Unit: [mm (in.)]



- Install the driver inside an enclosure whose pollution degree is 2 or better environment, or whose degree of protection is IP54 minimum.
- Do not install any equipment that generates a large amount of heat or noise near the driver.
- Do not install the driver underneath the controller or other equipment vulnerable to heat.
- If the ambient temperature of the driver exceeds 50 °C (122 °F), reconsider the ventilation condition.
- Be sure to install the driver vertically (vertical position).

Connection

Connection method for connectors

● CN1 connector

- Applicable lead wire: AWG28 to 16 (0.08 to 1.25 mm²)
- Stripping length of wire insulation: 7 mm (0.28 in.)
- Nominal size: M2
- Tightening torque: 0.22 to 0.25 N·m (31 to 35 oz-in)

Insert each lead wire into the CN1 connector and tighten the screw using a slotted screwdriver.

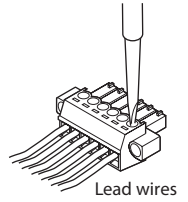

● CN2/CN3 connectors

- Applicable lead wire: AWG16 to 14 (1.25 to 2.0 mm²)
- Stripping length of wire insulation: 8 to 9 mm (0.31 to 0.35 in.)

1. Insert the connector wiring lever.
2. Insert the lead wire while pushing down the connector wiring lever.

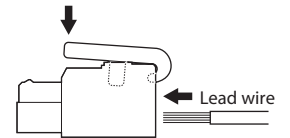

You can also use a slotted screwdriver.

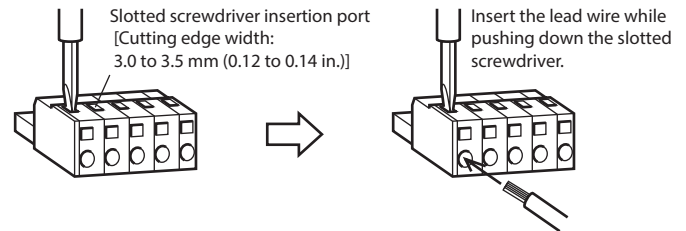

● CN6/CN7 connectors

- Applicable lead wire: AWG28 to 24 (0.08 to 0.2 mm²)

The tightening torque of a screw varies depending on the manufacturer of the connector. Check the manufacturer and tightening torque of the connector before tightening the screw. Check the manufacturer name with the connector case.

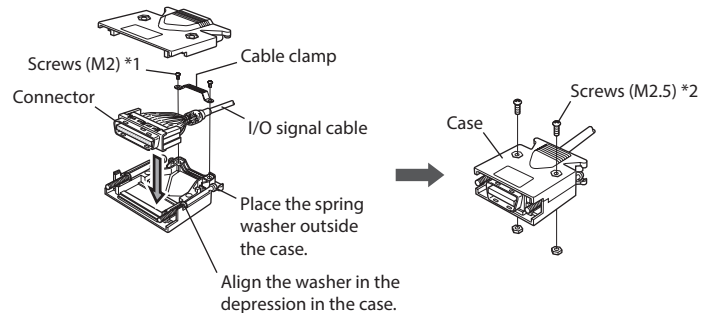

*1 The tightening torque is shown in the table.

Manufacturer of connector	Tightening torque [N·m (oz-in)]
3M Company	0.15 to 0.25 (21 to 35)
Molex Incorporated	0.3 to 0.35 (42 to 49)

*2 The tightening torque is shown in the table.

Manufacturer of connector	Tightening torque [N·m (oz-in)]
3M Company	0.16 to 0.2 (22 to 28)
Molex Incorporated	0.5 to 0.55 (71 to 78)

■ Connecting the motor

● Connection example (The electromagnetic brake motor)

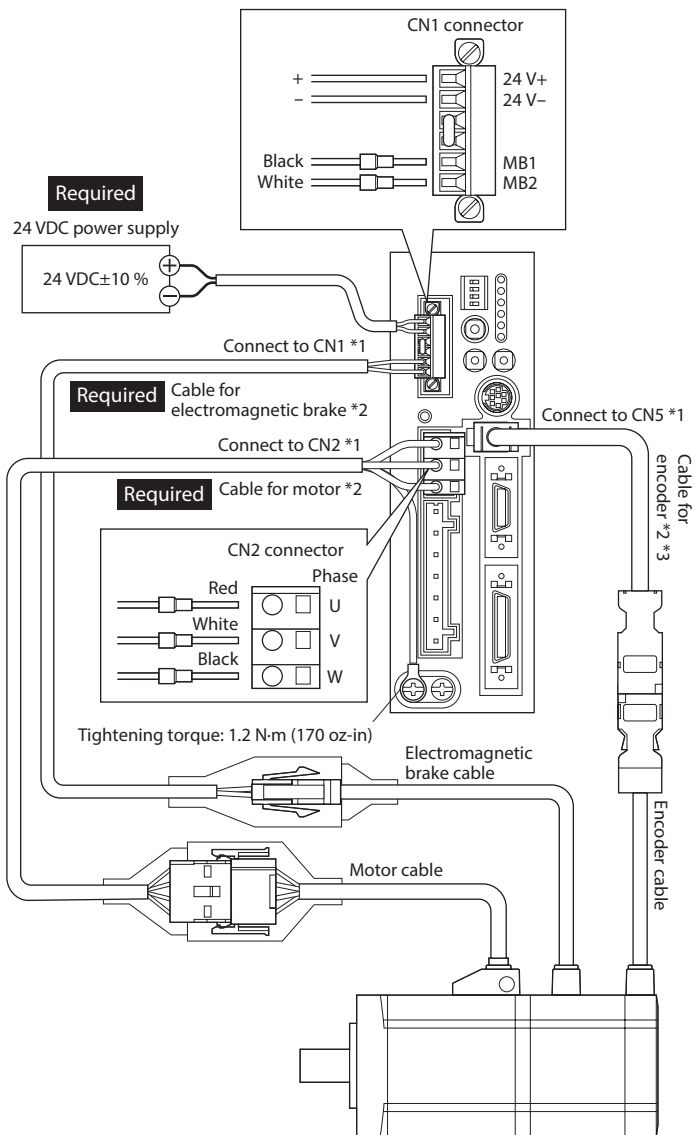

- *1 Keep 20 m (65.6 ft.) or less for the extension length between the motor and driver.
- *2 These cables are provided as our products. These cables are included with the product or sold separately.
- *3 Use the cable for encoder when the length of the encoder cable of motor is not enough.



- The lead wires of the cable for electromagnetic brake have polarities, so connect them in the correct polarity. If the lead wires are connected with their polarities reversed, the electromagnetic brake will not operate properly.
- Connect the connectors securely. Insecure connector connection may cause malfunction or damage to the motor or driver.
- When connecting or disconnecting the connector, turn off the power and wait for the CHARGE LED to turn off before doing so. The residual voltage may cause electric shock.



When installing the motor on a moving part, use our flexible cable offering excellent flexibility. Check on the Oriental Motor Website for the model name of cables.

■ Connecting the I/O signals

Solder the I/O signal cable (AWG28 to 24: 0.08 to 0.2 mm²) to the CN7 connector (36 pins). Use a shielded cable for I/O signals.

Connector pin assignment (viewed from soldering side)

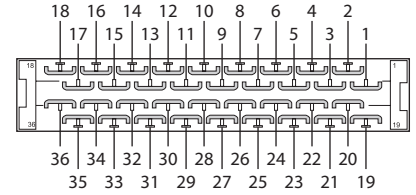

● Connecting the connector (CN7)

Insert the CN7 connector into the I/O signal connector (CN7) on the driver, and tighten the screws. The tightening torque of a screw varies depending on the manufacturer of the connector. Check the manufacturer and tightening torque of the connector before tightening the screw. Check the manufacturer name with the connector case.

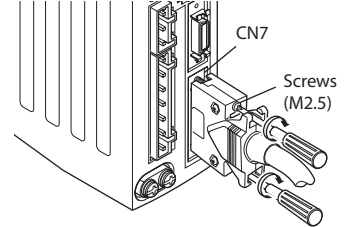

Manufacturer of connector	Tightening torque [N-m (oz-in)]
3M Company	0.15 to 0.25 (21 to 35)
Molex Incorporated	0.3 to 0.35 (42 to 49)



Be certain the I/O signal cable is as short as possible. The maximum input frequency will decrease as the cable length increases.

● Connector function table (Position control mode)

Pin No.	Signal name	Name
1	–	–
2	GND	Ground connection
3	ASG+	A-phase pulse line-driver output
4	ASG–	B-phase pulse line-driver output
5	BSG+	Z-phase pulse line-driver output
6	BSG–	
7	ZSG1+	
8	ZSG1–	
9	ALM+	Alarm output
10	ALM–	
11	WNG+/MOVE+*/MBC+*	Warning output/ Motor moving output*/ Electromagnetic brake control signal output*
12	WNG–/MOVE–*/MBC–*	
13	END+	Positioning complete output
14	END–	
15	READY+/AL0+*/P-OUTR+	Operation ready complete output/ Alarm code output bit0*/ Position data output ready output
16	READY–/AL0–*/P-OUTR–	
17	TLC+/AL1+*/P-OUT0+	Torque limit output/ Alarm code output bit1*/ Position data output bit0
18	TLC–/AL1–*/P-OUT0–	
19	ZSG2+/NEAR+*/AL2+*/P-OUT1+	Z-phase pulse open-collector output/ Near position output*/ Alarm code output bit2*/ Position data output bit1
20	ZSG2–/NEAR–*/AL2–*/P-OUT1–	
21	GND	Ground connection
22	IN-COM	Input common

Pin No.	Signal name	Name
23	S-ON	Servo on input
24	CLR/ALM-RST/P-CK	Deviation clear input/ Alarm reset input/ Position data transmission clock input
25	P-REQ	Position data request input
26	TL	Torque limit enable input
27	M0	Data selection input
28	M1	
29	P-PRESET	Position preset input
30	FREE	Shaft free input
31	CW+/PLS+	CW pulse input/Pulse input
32	CW-/PLS-	
33	CW+24 V/PLS+24 V	CW pulse/Pulse input for 24 V
34	CCW+24 V/DIR+24 V	CCW pulse input/Direction input for 24 V
35	CCW+/DIR+	CCW pulse input/Direction input
36	CCW-/DIR-	

* The signal will become effective if the applicable setting has been changed using the **MEXE02** or **OPX-2A**.



Functions of the connector vary depending on the control mode. Check the **USER MANUAL** for other control modes except position control mode.

Connecting the analog I/O signals

About the connector (20 pins) for the analog I/O connector (CN6), use our accessory set. Check on the Oriental Motor Website for the model name. Solder the analog I/O cable (AWG28 to 24: 0.08 to 0.2 mm²) to the CN6 connector. Use a shielded cable for analog I/O signals.

Connector pin assignment (viewed from soldering side)

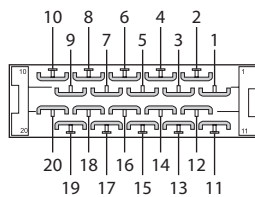

Connecting the connector (CN6)

Insert the CN6 connector into the analog I/O connector (CN6) on the driver, and tighten the screws. The tightening torque of a screw varies depending on the manufacturer of the connector. Check the manufacturer and tightening torque of the connector before tightening the screw. Check the manufacturer name with the connector case.

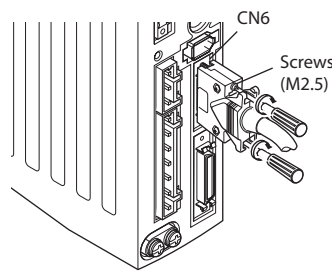

Manufacturer of connector	Tightening torque [N·m (oz·in)]
3M Company	0.15 to 0.25 (21 to 35)
Molex Incorporated	0.3 to 0.35 (42 to 49)

Connector function table

Pin No.	Signal name	Name	Description
1	V-REF	Analog speed (command/limit) input	Terminal used to input an analog speed (command/limit).
2	SG	Signal ground	Ground for analog I/O signals.

Pin No.	Signal name	Name	Description
3	P-VREF	Reference voltage output for analog speed (command/limit) input	A power supply output used to connect a variable resistor to the analog speed (command/limit) input.
4	P-TREF	Reference voltage output for analog torque (command/limit) input	Power supply output used to connect a variable resistor to the analog torque (command/limit) input.
5	T-REF	Analog torque (command/limit) input	Terminal used to input an analog torque (command/limit).
6	SG	Signal ground	Ground for analog I/O signals.
7	V-MON	Analog speed monitor output	Voltage corresponding to the monitored analog speed is output from here.
8	SG	Signal ground	Ground for analog I/O signals.
9	T-MON	Analog torque monitor output	Voltage corresponding to the monitored analog torque is output from here.
10	SG	Signal ground	Ground for analog I/O signals.
11 to 20	-	-	-

Connecting the main power supply

Use the CN3 connector (7 pins) to connect the power supply cable (AWG16 to 14: 1.25 to 2.0 mm²) to the main power supply connector (CN3) on the driver.



- Do not wire the power supply cable of the driver in the same cable duct with other power line or motor cable. Doing so may cause malfunction due to noise.
- When connecting or disconnecting the CN3 connector, turn off the power and wait for the CHARGE LED to turn off before doing so. The residual voltage may cause electric shock.



The current capacity of the power supply as shown below is the value when operating the motor in the continuous duty region. When operating in the limited duty region, the current will flow maximum three times as much as the continuous region. Refer to the **USER MANUAL** for the continuous duty region and limited duty region.

The current capacity of the power supply

Model	Single-phase 100-115 V	Single-phase 200-230 V	Three-phase 200-230 V
NX45	1.9 A or more	1.2 A or more	0.7 A or more
NX410	2.9 A or more	1.8 A or more	1.0 A or more
NX65	1.9 A or more	1.2 A or more	0.7 A or more
NX610	2.9 A or more	1.8 A or more	1.0 A or more
NX620	4.6 A or more	2.8 A or more	1.6 A or more
NX640	-	-	2.8 A or more
NX810	2.8 A or more	1.8 A or more	1.0 A or more
NX820 NX920	4.6 A or more	2.8 A or more	1.6 A or more
NX940	-	-	2.8 A or more
NX975	-	-	4.7 A or more
NX1040	-	-	2.9 A or more
NX1075	-	-	4.7 A or more

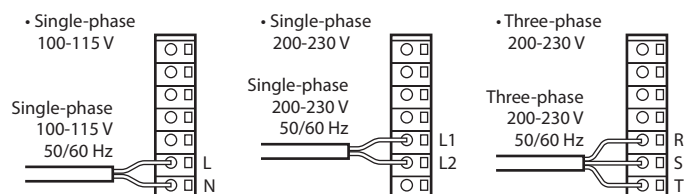

■ Grounding the driver

Two Protective Earth Terminals (nominal size: M4) are provided on the driver. Be sure to ground one of the Protective Earth Terminals.

- Grounding wire: AWG16 to 14 (1.25 to 2.0 mm²)
- Tightening torque: 1.2 N·m (170 oz-in)

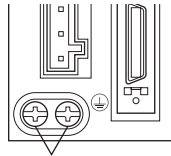

Protective Earth Terminal
(Ground either of the terminals.)

Connect the Protective Earth wire of the cable for motor to a terminal that is not grounded.

When grounding the Protective Earth Terminal, use a round terminal and secure the grounding point near the driver.

Do not share the grounding wire with a welder or any other power equipment.

■ Connecting the 24 VDC power supply input, regeneration resistor and electromagnetic brake

Use the CN1 connector (6 pins) to connect the 24 VDC power supply input, regeneration resistor thermal input and electromagnetic brake. Connect the lead wire (AWG28 to 16: 0.08 to 1.25 mm²) to the connector while checking in the table.

Display	Description
24V+	24 VDC power supply input (Be sure to connect these terminals when an electromagnetic brake is used.)
24V-	
TH1	Regeneration resistor thermal inputs (If these terminals are not used, short them using a jumper wire.)
TH2	
MB1	Electromagnetic brake - (Connect the black lead wire of the electromagnetic brake.)
MB2	Electromagnetic brake + (Connect the white lead wire of the electromagnetic brake.)

● Connecting the connector (CN1)

Tightening torque:
0.4 N·m (56 oz-in)

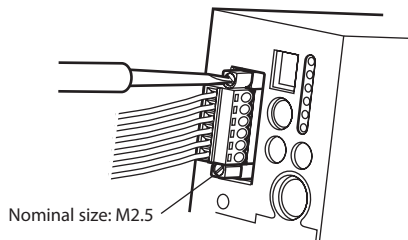

● Connecting the 24 VDC power supply input

Once a 24 VDC power supply is connected, you can check the contents of alarms that have generated even when the main power supply is cut off. Since the 24 VDC power supply is not used for operating the motor, connect it as necessary.

When the electromagnetic brake motor is used, be sure to connect the 24 VDC power supply of the following capacity.

Model	Voltage	Current capacity	
		Without electromagnetic brake	With electromagnetic brake
NX45, NX410 NX65, NX610 NX620, NX640 NX810, NX820 NX920, NX940	24 VDC±10 %	0.4 A or more	0.7 A or more
NX975, NX1040 NX1075			0.8 A or more

● Connecting the regeneration resistor

• When the internal regeneration resistor is used

The driver has an internal regeneration resistor. The driver is shipped with the TH1 and TH2 terminals of CN1, and RG2 and RG3 terminals of CN3, shorted respectively to enable the internal regeneration resistor.

• When our regeneration resistor is used

Use our regeneration resistor if gravitational operation or other operation involving up/down movement, or sudden starting/stopping of a large inertia load, will be repeated frequently. Check on the Oriental Motor Website for the model name.

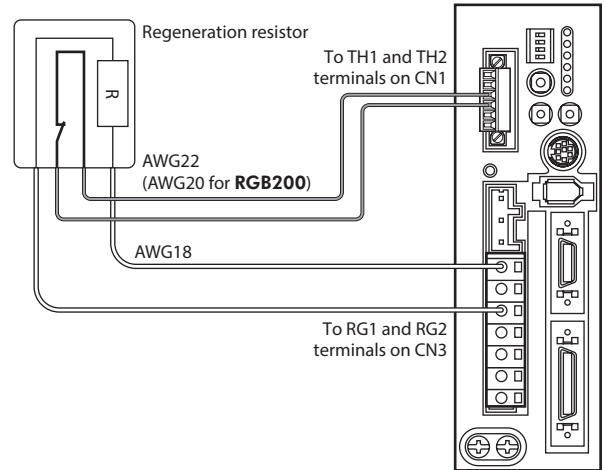

- When connecting our regeneration resistor, be sure to remove the jumper wires from the CN1 connector and CN3 connector.
- If the current consumption of the regeneration resistor exceeds the allowable level, the thermostat will be triggered and a regeneration resistor overheat alarm will generate. If a regeneration resistor overheat alarm generates, turn off the power and check the content of the error.

● Connecting the electromagnetic brake

Refer to "Connecting the motor" on p.8.

■ Connecting the battery

1. Hold the driver with its bottom facing up and connect the connector attached at the end of the battery lead wires into the battery connector.
2. Hook the tabs on the battery connector onto the mating parts on the driver.
3. Push in the battery holder carefully by ensuring that the lead wires are not pinched.

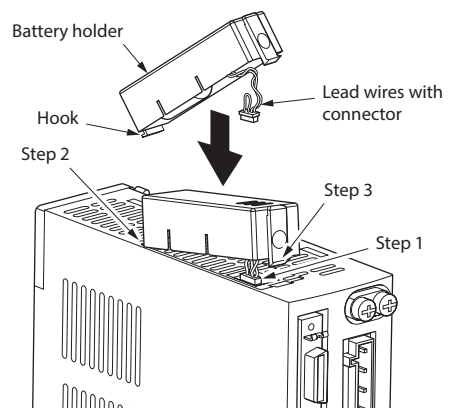

Note

- Installing or removing the battery must be performed by qualified personnel with expert knowledge of the handling of the driver and battery.
- Remove the battery if the driver is not turned on for an extended period exceeding the data retention period. Failure to do so may cause the battery fluid to leak or battery performance to drop.
- When installing or removing the battery, cut off the main power supply and 24 VDC power supply of the driver.
- Once the battery is disconnected, the absolute motor position stored in the driver will be lost. After the battery has been installed, be sure to set the absolute motor position again.

Connecting the data setter

Connect our communication cable for the support software or the **OPX-2A** cable to the CN4 on the driver.

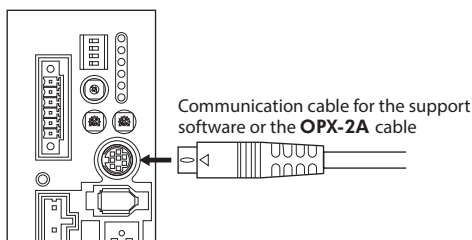

CAUTION

The data edit connector (CN4) and the analog I/O connector (CN6) on the driver are not electrically insulated. When grounding the positive terminal of the power supply, do not connect any equipment (PC, etc.) whose negative terminal is grounded. Doing so may cause the driver and these equipment to short, damaging both.

Setting

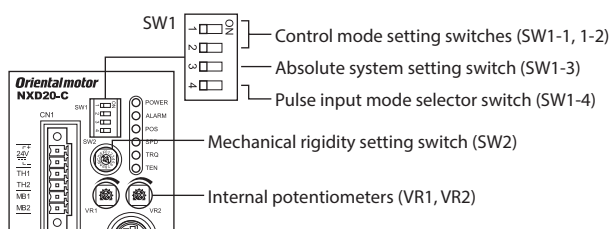

memo

The new setting of the absolute system setting switch (SW1-3) and the pulse input mode selector switch (SW1-4) will become effective after the power is turned on again. If a 24 VDC power supply is used, also turn on the 24 VDC power supply again.

Control mode (SW1-1, 1-2)

These switches are used to set the control mode of the driver (position control, speed control, torque control or tension control).

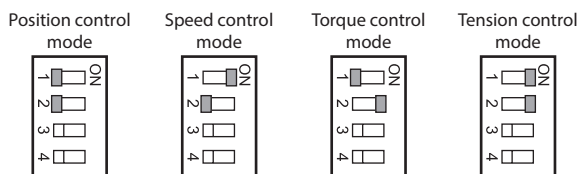

Absolute system (SW1-3)

Install our battery **BAT01A**. When the battery is connected, the current position will be retained even in the event of power outage or after the driver power is cut off.

ON: Enable the absolute function

OFF: Disable the absolute function (factory setting)

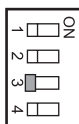

Pulse input mode (SW1-4)

ON: 1-pulse input mode, negative logic
OFF: 2-pulse input mode, negative logic

Each mode can only be set with a negative logic using the pulse input mode selector switch. To select a positive logic, set the applicable parameter using the **MEXE02** or **OPX-2A**. The factory setting depends on the destination country.

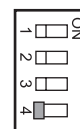

Mechanical rigidity (SW2)

What is set with this switch varies depending on the control mode.

Control mode	Description
Position control mode	The switch sets the gain adjustment level according to the mechanical rigidity.
Speed control mode	
Torque control mode	Not used.
Tension control mode	The switch sets the minimum speed in the simple mode. The switch is not used in high function mode I or high function mode II.

Internal potentiometers (VR1, VR2)

What is set with these potentiometers varies depending on the control mode.

Control mode	Internal potentiometers	Description
Position control mode	VR1	This potentiometer sets the damping control frequency.
	VR2	Not used.
Speed control mode	VR1	This potentiometer sets the speed command value.
	VR2	This potentiometer sets the acceleration/deceleration time.
Torque control mode	VR1	This potentiometer sets the torque command value.
	VR2	This potentiometer sets the speed limit.
Tension control mode	VR1	This potentiometer sets the tension command value.
	VR2	This potentiometer sets the speed limit.

Inspection

It is recommended that periodic inspections be conducted for the items listed below after each operation of the motor. If an abnormal condition is noted, discontinue any use and contact your nearest Oriental Motor sales office.

Inspection item

- Check if the openings in the driver are clogged.
- Check if any of the screws having installed a driver is loose.
- Check if any of the connection parts of the connector is loose.
- Check if the driver has unusual smells or appearance defects.

Note

The driver uses semiconductor components. Static electricity may damage the semiconductor components of the driver, so be extremely careful when handling driver.

General specifications

Operation environment	Degree of protection	IP20
	Ambient temperature	0 to +50 °C (+32 to +122 °F) (non-freezing)
	Humidity	85 % or less (non-condensing)
	Altitude	Up to 1,000 m (3,300 ft.) above sea level
	Surrounding atmosphere	No corrosive gas, dust, water or oil
Storage environment	Ambient temperature	-25 to +70 °C (-13 to +158 °F) (non-freezing)
	Humidity	85 % or less (non-condensing)
	Altitude	Up to 3,000 m (10,000 ft.) above sea level
	Surrounding atmosphere	No corrosive gas, dust, water or oil
Shipping environment	Ambient temperature	-25 to +70 °C (-13 to +158 °F) (non-freezing)
	Humidity	85 % or less (non-condensing)
	Altitude	Up to 3,000 m (10,000 ft.) above sea level
	Surrounding atmosphere	No corrosive gas, dust, water or oil

Note

- Maximum Surrounding Air Temperature +40 to +50 °C (+104 to +122 °F). When the surrounding air temperature exceeds +40 °C (+104 °F), continuous motor output power shall be within the derating curve. (NXD20-A and NXD20-C)
- Maximum Surrounding Air Temperature +50 °C (+122 °F). When the surrounding air temperature exceeds +45 °C (+113 °F), continuous motor output power shall be within the derating curve. (NXD75-S)

- Derating curve for continuous motor output;
Rated output: 100 W

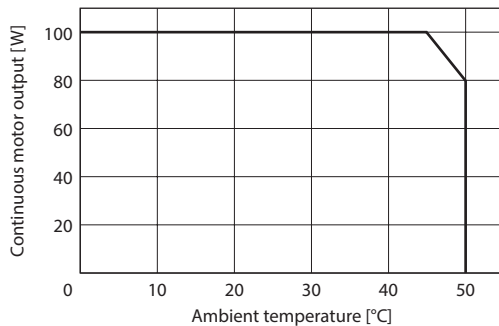

- Derating curve for continuous motor output;
Rated output: 200 W

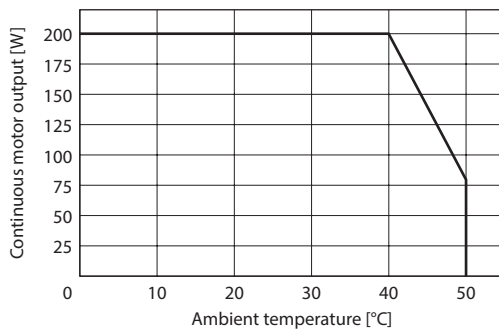

- Derating curve for continuous motor output;
Rated output: 750 W

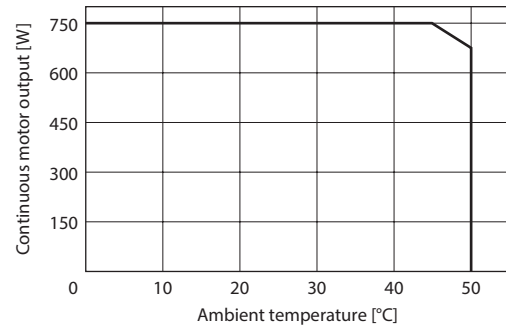

- Unauthorized reproduction or copying of all or part of this manual is prohibited.
- Oriental Motor shall not be liable whatsoever for any problems relating to industrial property rights arising from use of any information, circuit, equipment or device provided or referenced in this manual.
- Characteristics, specifications and dimensions are subject to change without notice.
- While we make every effort to offer accurate information in the manual, we welcome your input. Should you find unclear descriptions, errors or omissions, please contact your nearest Oriental Motor sales office.
- **Oriental motor** is a registered trademark or trademark of Oriental Motor Co., Ltd., in Japan and other countries.

© Copyright ORIENTAL MOTOR CO., LTD. 2012

Published in October 2021

- Please contact your nearest Oriental Motor office for further information.

ORIENTAL MOTOR U.S.A. CORP.
Technical Support Tel:800-468-3982
8:30am EST to 5:00pm PST (M-F)
www.orientalmotor.com

ORIENTAL MOTOR (EUROPA) GmbH
Schiesstraße 44, 40549 Düsseldorf, Germany
Technical Support Tel:00 800/22 55 66 22
www.orientalmotor.de

ORIENTAL MOTOR (UK) LTD.
Unit 5 Faraday Office Park, Rankine Road,
Basingstoke, Hampshire RG24 8QB UK
Tel:+44-1256347090
www.oriental-motor.co.uk

ORIENTAL MOTOR (FRANCE) SARL
Tel:+33-1 47 86 97 50
www.orientalmotor.fr

ORIENTAL MOTOR ITALIA s.r.l.
Tel:+39-02-93906347
www.orientalmotor.it

ORIENTAL MOTOR CO., LTD.
4-8-1 Higashiueno, Taito-ku, Tokyo 110-8536
Japan
Tel:+81-3-6744-0361
www.orientalmotor.co.jp

ORIENTAL MOTOR ASIA PACIFIC PTE. LTD.
Singapore
Tel:1800-842-0280
www.orientalmotor.com.sg

ORIENTAL MOTOR (MALAYSIA) SDN. BHD.
Tel:1800-806-161
www.orientalmotor.com.my

ORIENTAL MOTOR (THAILAND) CO., LTD.
Tel:1800-888-881
www.orientalmotor.co.th

ORIENTAL MOTOR (INDIA) PVT. LTD.
Tel:1800-120-1995 (For English)
1800-121-4149 (For Hindi)

www.orientalmotor.co.in
TAIWAN ORIENTAL MOTOR CO., LTD.
Tel:0800-060708

www.orientalmotor.com.tw
SHANGHAI ORIENTAL MOTOR CO., LTD.
Tel:400-820-6516

www.orientalmotor.com.cn
INA ORIENTAL MOTOR CO., LTD.
Korea

Tel:080-777-2042
www.inaom.co.kr