

Motorized actuator

- Motorized linear slide
- Motorized cylinder

Function Setting Edition

Introduction

Motorized actuator
equipped the AZ Series

Motorized actuator
equipped the AR Series

Thank you for purchasing an Oriental Motor product.

This Manual describes product handling procedures and safety precautions.

- Please read it thoroughly to ensure safe operation.
- Always keep the manual where it is readily available.

1 Introduction

1	Introduction	4
1-1	Before use	4
1-2	Related operating manuals	4

2 Motorized actuator equipped the AZ Series

1	Setting of the motorized linear slide, motorized cylinder	6
1-1	Setting flow	6
1-2	Creating the recovery data file	7
1-3	Parameter setting list	8
1-4	Traveling direction of the moving part	14
1-5	Return-to-home operation	14
1-6	Push-motion return-to-home operation	16
1-7	Push-motion operation	18
1-8	Current setting of push-motion operation	19

3 Motorized actuator equipped the AR Series

1	Setting of the motorized linear slide, motorized cylinder	22
1-1	Setting flow	22
1-2	Parameter setting example	23
1-3	Traveling direction of the moving part	33
1-4	Operation setting	34
1-5	Return-to-home operation	36
1-6	Push-motion return-to-home operation	37
1-7	Push-motion operation	40
1-8	Current setting of push-motion operation	41

1 Introduction

◆ Table of contents





1	Introduction	4
	1-1 Before use.....	4
	1-2 Related operating manuals.....	4

1 Introduction

1-1 Before use

Only qualified personnel of electrical and mechanical engineering should work with the product. Use the product correctly after thoroughly reading the section "Safety precautions" on the [OPERATING MANUAL Actuator Edition](#). In addition, be sure to observe the contents described in warning, caution, and note in this manual. The motorized actuator is designed and manufactured to be incorporated in general industrial equipment. Do not use for any other purpose. Oriental Motor Co., Ltd. is not responsible for any damage caused through failure to observe this warning.

Notation on this manual

 DANGER	The instructions, which accompany a "DANGER" symbol, indicate that mishandling the product may result in an imminent danger leading to immediate death or serious injury.
 WARNING	Handling the product without observing the instructions that accompany a "WARNING" symbol may result in serious injury or death.
 CAUTION	Handling the product without observing the instructions that accompany a "CAUTION" symbol may result in injury or property damage.
 Note	The items under this heading contain important handling instructions that the user should observe to ensure safe use of the product.

1-2 Related operating manuals

For operating manuals, download from Oriental Motor Website Download Page or contact your nearest Oriental Motor sales office.

■ Motorized actuator equipped with the AZ Series

- OPERATING MANUAL Actuator Edition
- Motorized Actuator OPERATING MANUAL Function Setting Edition (this document)
- **AZ Series/Motorized Actuator equipped with AZ Series OPERATING MANUAL Function Edition**

Refer to the operating manual of the driver for contents not described in these manuals.

■ Motorized actuator equipped with the AR Series

- OPERATING MANUAL Actuator Edition
- Motorized Actuator OPERATING MANUAL Function Setting Edition (this document)
- **AR Series/Motorized Actuator equipped with AR Series USER MANUAL**

2 Motorized actuator equipped the AZ Series



◆ Table of contents

1	Setting of the motorized linear slide, motorized cylinder	6
1-1	Setting flow.....	6
1-2	Creating the recovery data file.....	7
1-3	Parameter setting list	8
1-4	Traveling direction of the moving part...	14
1-5	Return-to-home operation	14
1-6	Push-motion return-to-home operation	16
1-7	Push-motion operation	18
1-8	Current setting of push-motion operation	19

1 Setting of the motorized linear slide, motorized cylinder

This chapter explains the parameters and operation functions of the motorized linear slide, motorized cylinder. (Hereinafter described as motorized actuator)

1-1 Setting flow

1 Install the motorized actuator.

2 Install and connect a driver.

3 Start the MEXE02.

4 Parameters such as the traveling direction and minimum travel amount have been set in the ABZO sensor at the time of shipment.

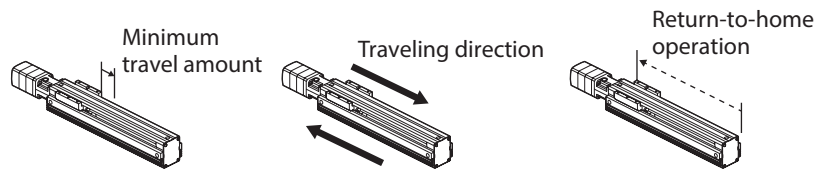

The operation data for the motorized actuator equipped the **AZ** Series is set on the millimeter unit.

5 Copy the ABZO information (fixed value) to the driver.

Using the MEXE02, match the ABZO information (fixed value) and the setting value of the driver parameter.

6 Create a recovery data file.

The ABZO information (fixed value) can be stored as the recovery data file.

Save the recovery data file in a PC as a data file. Refer to the **AZ** Series [OPERATING MANUAL Function Edition](#) for details.

7 Set the software limit when no sensor is used.

8 Check the movement of the motorized actuator.

Using the "Teaching, remote operation" of the MEXE02, check the movement of the motorized actuator.

9 Save the set data.

1-2 Creating the recovery data file

The recovery data file represents a file saved the factory setting of the product.
 Create the recovery data file initially in case of replacing the product for maintenance or product damage.
 Save the recovery data file in a PC as a data file.
 Refer to the **AZ Series OPERATING MANUAL Function Edition** for details.



- Be sure to create the recovery data file when the motorized actuator is used.
- Be sure to create the recovery data file before the motorized actuator is installed in equipment.

■ Motor for maintenance

The actuator model name indicated on the actuator nameplate and the corresponding motor model name for replacement are as follows.

Contact your nearest Oriental Motor sales office when purchasing.

● AC power input type

Motorized actuator model	Motor model
EASM4○○○○○○○AZAC	AZM46AC
EASM4○○○○○○○AZMC	AZM46MC
EASM6○○○○○○○AZAC	AZM66AC
EASM6○○○○○○○AZMC	AZM66MC
EACM4○○○○○○○AZAC-○	AZM46AC
EACM4○○○○○○○AZMC-○	AZM46MC
EACM6○○○○○○○AZAC-○	AZM66AC
EACM6○○○○○○○AZMC-○	AZM66MC
EZSM3○○○○○○○AZAC	AZM46AC
EZSM3○○○○○○○AZMC	AZM46MC
EZSM4○○○○○○○AZAC	AZM46AC
EZSM4○○○○○○○AZMC	AZM46MC
EZSM6○○○○○○○AZAC	AZM66AC
EZSM6○○○○○○○AZMC	AZM66MC
EZSHM6○○○○○○○AZAC	AZM66AC
EZSHM6○○○○○○○AZMC	AZM66MC

● DC power input type

Motorized actuator model	Motor model
EASM2○○○○○○○AZAK	AZM24AK
EASM4○○○○○○○AZAK	AZM46AK
EASM4○○○○○○○AZMK	AZM46MK
EASM6○○○○○○○AZAK	AZM66AK
EASM6○○○○○○○AZMK	AZM66MK
EACM2○○○○○○○AZAK-○	AZM24AK
EACM4○○○○○○○AZAK-○	AZM46AK
EACM4○○○○○○○AZMK-○	AZM46MK
EACM6○○○○○○○AZAK-○	AZM66AK
EACM6○○○○○○○AZMK-○	AZM66MK
EZSM3○○○○○○○AZAK	AZM46AK
EZSM3○○○○○○○AZMK	AZM46MK
EZSM4○○○○○○○AZAK	AZM46AK
EZSM4○○○○○○○AZMK	AZM46MK
EZSM6○○○○○○○AZAK	AZM66AK
EZSM6○○○○○○○AZMK	AZM66MK

1-3 Parameter setting list

Parameters for the motorized actuator are set as follows at the time of shipment.



- In the case of the motorized actuator of the DC power input type, the operating speed may not reach the maximum speed depending on the ambient temperature or motor cable length.
- In the case of the pulse input type driver, use the function setting switch in the state of the factory setting. If it is changed, the actuator operates with a certain number of resolution since the ABZO setting of the motor does not apply to the driver.
- AC power input type products of the **EASM6, EZSM6, EZSHM6** or **EACM6** model;
If a load is operated in a vertical direction, an overvoltage alarm may generate depending on the driving condition. When the alarm has generated, reconsider the operating condition or use our regeneration resistor.

■ Lead: 3 mm

Item	EAS/EAC Series factory setting	Standard/geared motor for maintenance (When replacing the motor)
• Lead [mm]	3	–
• Minimum travel amount [mm] (Resolution)	0.01 (300)	0.003 (1,000)
Base setting parameter		
• Electronic damper function	Enable (for motorized linear slide)	Enable (for standard/geared motor)
Motor & Mechanism parameter		
• Mechanism settings	Prioritize ABZO setting *1	Manual setting
• Electronic gear A	10	1
• Electronic gear B	3	1
• Motor rotation direction	Positive side=Clockwise	Positive side=Clockwise
• Mechanism type	mm	step
• Mechanism lead [mm]	3	1
• Mechanism lead decimal digit setting	×1 [mm]	
• JOG/HOME/ZHOME operation setting	Prioritize ABZO setting *1	Manual setting
• (JOG) Operating speed	10 [mm/s]	1,000 [Hz]
• (JOG) Acceleration/deceleration	0.5 [m/s ²]	1,000 [kHz/s]
• (JOG) Starting speed	5 [mm/s]	500 [Hz]
• (JOG) Operating speed (high)	50 [mm/s]	5,000 [Hz]
• (ZHOME) Operating speed	50 [mm/s]	5,000 [Hz]
• (ZHOME) Acceleration/deceleration	0.5 [m/s ²]	1,000 [kHz/s]
• (ZHOME) Starting speed	5 [mm/s]	500 [Hz]
• (HOME) Home-seeking mode	Push-motion	3-sensor
• (HOME) Starting direction	Negative side	Positive side
• (HOME) Acceleration/deceleration	0.5 [m/s ²]	1,000 [kHz/s]
• (HOME) Starting speed	5 [mm/s]	500 [Hz]
• (HOME) Operating speed	50 [mm/s]	5,000 [Hz]
• (HOME) Last speed	5 [mm/s]	500 [Hz]
• (HOME) Backward steps in 2 sensor home-seeking	5 [mm]	500 [step]
• (HOME) Operating amount in uni-directional home-seeking	5 [mm]	500 [step]
• (HOME) Operating current for push-home-seeking	This item has been set for each model.	100 [%]

Item	EAS/EAC Series factory setting	Standard/geared motor for maintenance (When replacing the motor)
• (HOME) Backward steps after first entry in push-home-seeking	4 [mm]	500 [step]
Mechanism protection parameter *2		
• Maximum starting speed	50 [mm/s]	4,000,000 [Hz]
• Maximum operating speed	150 [mm/s]	4,000,000 [Hz]
• Maximum pushing speed	25 [mm/s]	4,000,000 [Hz]
• Maximum pushing return-to-home speed	50 [mm/s]	4,000,000 [Hz]
• Maximum push current *3	This item has been set for each model.	100 [%]

*1 When changing the factory setting of parameter items, change the setting for the "Mechanism settings" parameter and "JOG/HOME/ZHOME operation setting" parameter to "Manual setting."

*2 Mechanism protection parameters cannot be set by customers.

*3 The push current actually usable is different from the push current having set. Check with the graph shown on p.19.

■ Lead: 6 mm

Item	EAS/EZS/EAC Series factory setting	Standard/geared motor for maintenance (When replacing the motor)
• Lead [mm]	6	–
• Minimum travel amount [mm] (Resolution)	0.01 (600)	0.006 (1,000)
Base setting parameter		
• Electronic damper function	Enable (for motorized linear slide)	Enable (for standard/geared motor)
Motor & Mechanism parameter		
• Mechanism settings	Prioritize ABZO setting *1	Manual setting
• Electronic gear A	5	1
• Electronic gear B	3	1
• Motor rotation direction	In-line motor mounting type	Positive side=Clockwise
	Parallel motor mounting type	
• Mechanism type	mm	step
• Mechanism lead [mm]	6	1
• Mechanism lead decimal digit setting	×1 [mm]	
• JOG/HOME/ZHOME operation setting	Prioritize ABZO setting *1	Manual setting
• (JOG) Operating speed	10 [mm/s]	1,000 [Hz]
• (JOG) Acceleration/deceleration	0.5 [m/s ²]	1,000 [kHz/s]
• (JOG) Starting speed	5 [mm/s]	500 [Hz]
• (JOG) Operating speed (high)	50 [mm/s]	5,000 [Hz]
• (ZHOME) Operating speed	50 [mm/s]	5,000 [Hz]
• (ZHOME) Acceleration/deceleration	0.5 [m/s ²]	1,000 [kHz/s]
• (ZHOME) Starting speed	5 [mm/s]	500 [Hz]
• (HOME) Home-seeking mode	Push-motion	3-sensor
• (HOME) Starting direction	In-line motor mounting type	Positive side
	Parallel motor mounting type	
• (HOME) Acceleration/deceleration	0.5 [m/s ²]	1,000 [kHz/s]

Item		EAS/EZS/EAC Series factory setting	Standard/geared motor for maintenance (When replacing the motor)
• (HOME) Starting speed		5 [mm/s]	500 [Hz]
• (HOME) Operating speed		50 [mm/s]	5,000 [Hz]
• (HOME) Last speed		5 [mm/s]	500 [Hz]
• (HOME) Backward steps in 2 sensor home-seeking		5 [mm]	500 [step]
• (HOME) Operating amount in uni-directional home-seeking		5 [mm]	500 [step]
• (HOME) Operating current for push-home-seeking		This item has been set for each model.	100 [%]
• (HOME) Backward steps after first entry in push-home-seeking	EASM4, EZSM3, EZSM4	3 [mm]	500 [step]
	EASM6, EZSM6	6 [mm]	
	EASM2, EACM2, EACM4, EACM6	4 [mm]	
Mechanism protection parameter *2			
• Maximum starting speed		100 [mm/s]	4,000,000 [Hz]
• Maximum operating speed		This item has been set for each model.	4,000,000 [Hz]
• Maximum pushing speed		25 [mm/s]	4,000,000 [Hz]
• Maximum pushing return-to-home speed		50 [mm/s]	4,000,000 [Hz]
• Maximum push current *3		This item has been set for each model.	100 [%]

*1 When changing the factory setting of parameter items, change the setting for the “Mechanism settings” parameter and “JOG/HOME/ZHOME operation setting” parameter to “Manual setting.”

*2 Mechanism protection parameters cannot be set by customers.

*3 The push current actually usable is different from the push current having set. Check with the graph shown on p.19.

■ **Lead: 12 mm**

Item		EAS/EZS/EAC Series factory setting	Standard/geared motor for maintenance (When replacing the motor)
• Lead [mm]		12	–
• Minimum travel amount [mm] (Resolution)		0.01 (1,200)	0.012 (1,000)
Base setting parameter			
• Electronic damper function		Enable (for motorized linear slide)	Enable (for standard/geared motor)
Motor & Mechanism parameter			
• Mechanism settings		Prioritize ABZO setting *1	Manual setting
• Electronic gear A		5	1
• Electronic gear B		6	1
• Motor rotation direction	In-line motor mounting type	Positive side=Clockwise	Positive side=Clockwise
	Parallel motor mounting type	Positive side=Counterclockwise	
• Mechanism type		mm	step
• Mechanism lead [mm]		12	1
• Mechanism lead decimal digit setting		×1 [mm]	
• JOG/HOME/ZHOME operation setting		Prioritize ABZO setting *1	Manual setting
• (JOG) Operating speed		10 [mm/s]	1,000 [Hz]

Item		EAS/EZS/EAC Series factory setting	Standard/geared motor for maintenance (When replacing the motor)
• (JOG) Acceleration/deceleration		0.5 [m/s ²]	1,000 [kHz/s]
• (JOG) Starting speed		5 [mm/s]	500 [Hz]
• (JOG) Operating speed (high)		50 [mm/s]	5,000 [Hz]
• (ZHOME) Operating speed		100 [mm/s]	5,000 [Hz]
• (ZHOME) Acceleration/deceleration		0.5 [m/s ²]	1,000 [kHz/s]
• (ZHOME) Starting speed		5 [mm/s]	500 [Hz]
• (HOME) Home-seeking mode		Push-motion	3-sensor
• (HOME) Starting direction	In-line motor mounting type	Negative side	Positive side
	Parallel motor mounting type	Negative side	
• (HOME) Acceleration/deceleration		0.5 [m/s ²]	1,000 [kHz/s]
• (HOME) Starting speed		5 [mm/s]	500 [Hz]
• (HOME) Operating speed		100 [mm/s]	5,000 [Hz]
• (HOME) Last speed		5 [mm/s]	500 [Hz]
• (HOME) Backward steps in 2 sensor home- seeking		5 [mm]	500 [step]
• (HOME) Operating amount in uni-directional home-seeking		5 [mm]	500 [step]
• (HOME) Operating current for push-home- seeking		This item has been set for each model.	100 [%]
• (HOME) Backward steps after first entry in push-home-seeking	EASM4, EZSM3, EZSM4	3 [mm]	500 [step]
	EASM6, EZSM6	6 [mm]	
	EACM4, EACM6	4 [mm]	
Mechanism protection parameter *2			
• Maximum starting speed		200 [mm/s]	4,000,000 [Hz]
• Maximum operating speed		This item has been set for each model.	4,000,000 [Hz]
• Maximum pushing speed		25 [mm/s]	4,000,000 [Hz]
• Maximum pushing return-to-home speed		100 [mm/s]	4,000,000 [Hz]
• Maximum push current *3		This item has been set for each model.	100 [%]

*1 When changing the factory setting of parameter items, change the setting for the "Mechanism settings" parameter and "JOG/HOME/ZHOME operation setting" parameter to "Manual setting."

*2 Mechanism protection parameters cannot be set by customers.

*3 The push current actually usable is different from the push current having set. Check with the graph shown on p.19.

■ Lead: 20 mm

Item	EZSH Series factory setting	Standard/geared motor for maintenance (When replacing the motor)
• Lead [mm]	20	–
• Minimum travel amount [mm] (Resolution)	0.01 (2,000)	0.02 (1,000)
Base setting parameter		
• Electronic damper function	Enable	Enable
Motor & Mechanism parameter		
• Mechanism settings	Prioritize ABZO setting *1	Manual setting
• Electronic gear A	1	1
• Electronic gear B	2	1
• Motor rotation direction	Positive side=Clockwise	Positive side=Clockwise
• Mechanism type	mm	step
• Mechanism lead [mm]	20	1
• Mechanism lead decimal digit setting	×1 [mm]	
• Mechanism limit parameter setting	Follow ABZO setting	Disable
• Mechanism protection parameter setting	Follow ABZO setting	Disable
• JOG/HOME/ZHOME operation setting	Prioritize ABZO setting *1	Manual setting
• (JOG) Operating speed	10 [mm/s]	1,000 [Hz]
• (JOG) Acceleration/deceleration	0.5 [m/s ²]	1,000 [kHz/s]
• (JOG) Starting speed	5 [mm/s]	500 [Hz]
• (JOG) Operating speed (high)	50 [mm/s]	5,000 [Hz]
• (ZHOME) Operating speed	100 [mm/s]	5,000 [Hz]
• (ZHOME) Acceleration/deceleration	0.5 [m/s ²]	1,000 [kHz/s]
• (ZHOME) Starting speed	5 [mm/s]	500 [Hz]
• (HOME) Home-seeking mode	3-sensor	3-sensor
• (HOME) Starting direction	Negative side	Positive side
• (HOME) Acceleration/deceleration	0.5 [m/s ²]	1,000 [kHz/s]
• (HOME) Starting speed	5 [mm/s]	500 [Hz]
• (HOME) Operating speed	100 [mm/s]	5,000 [Hz]
• (HOME) Last speed	5 [mm/s]	500 [Hz]
• (HOME) Backward steps in 2 sensor home-seeking	5 [mm]	500 [step]
• (HOME) Operating amount in uni-directional home-seeking	5 [mm]	500 [step]
Mechanism protection parameter *2		
• Maximum starting speed	200 [mm/s]	4,000,000 [Hz]
• Maximum operating speed	This item has been set for each model.	4,000,000 [Hz]
• Maximum pushing speed	25 [mm/s]	4,000,000 [Hz]
• Maximum push current *3	100 [%]	100 [%]

*1 When changing the factory setting of parameter items, change the setting for the “Mechanism settings” parameter and “JOG/HOME/ZHOME operation setting” parameter to “Manual setting.”

*2 Mechanism protection parameters cannot be set by customers.

*3 The push current actually usable is different from the push current having set. Check with the graph shown on p.19.

■ Lead: 30 mm



- Do not enter the moving range of the motorized actuator while the power is supplied. Doing so may result in serious injury.
- Be sure to provide a safety cage according to EN ISO 13857. Also, touching a table by hand may cause serious injury.
- Operate the data setter outside the safety cage. Failure to do so may result in injury.

Item	EZSH Series factory setting	Standard/geared motor for maintenance (When replacing the motor)
• Lead [mm]	30	–
• Minimum travel amount [mm] (Resolution)	0.01 (3,000)	0.03 (1,000)
Base setting parameter		
• Electronic damper function	Enable	Enable
Motor & Mechanism parameter		
• Mechanism settings	Prioritize ABZO setting *1	Manual setting
• Electronic gear A	1	1
• Electronic gear B	3	1
• Motor rotation direction	Positive side=Clockwise	Positive side=Clockwise
• Mechanism type	mm	step
• Mechanism lead [mm]	30	1
• Mechanism lead decimal digit setting	×1 [mm]	
• Mechanism limit parameter setting	Follow ABZO setting	Disable
• Mechanism protection parameter setting	Follow ABZO setting	Disable
• JOG/HOME/ZHOME operation setting	Prioritize ABZO setting *1	Manual setting
• (JOG) Operating speed	10 [mm/s]	1,000 [Hz]
• (JOG) Acceleration/deceleration	0.5 [m/s ²]	1,000 [kHz/s]
• (JOG) Starting speed	5 [mm/s]	500 [Hz]
• (JOG) Operating speed (high)	50 [mm/s]	5,000 [Hz]
• (ZHOME) Operating speed	100 [mm/s]	5,000 [Hz]
• (ZHOME) Acceleration/deceleration	0.5 [m/s ²]	1,000 [kHz/s]
• (ZHOME) Starting speed	5 [mm/s]	500 [Hz]
• (HOME) Home-seeking mode	3-sensor	3-sensor
• (HOME) Starting direction	Negative side	Positive side
• (HOME) Acceleration/deceleration	0.5 [m/s ²]	1,000 [kHz/s]
• (HOME) Starting speed	5 [mm/s]	500 [Hz]
• (HOME) Operating speed	100 [mm/s]	5,000 [Hz]
• (HOME) Last speed	5 [mm/s]	500 [Hz]
• (HOME) Backward steps in 2 sensor home-seeking	5 [mm]	500 [step]
• (HOME) Operating amount in uni-directional home-seeking	5 [mm]	500 [step]
Mechanism protection parameter *2		
• Maximum starting speed	200 [mm/s]	4,000,000 [Hz]
• Maximum operating speed	This item has been set for each model.	4,000,000 [Hz]
• Maximum pushing speed	25 [mm/s]	4,000,000 [Hz]
• Maximum push current *3	100 [%]	100 [%]

*1 When changing the factory setting of parameter items, change the setting for the “Mechanism settings” parameter and “JOG/HOME/ZHOME operation setting” parameter to “Manual setting.”

*2 Mechanism protection parameters cannot be set by customers.

*3 The push current actually usable is different from the push current having set. Check with the graph shown on p.19.

1-4 Traveling direction of the moving part

The traveling direction of the moving part varies depending on the setting of the travel amount or the input method of the pulse signal.

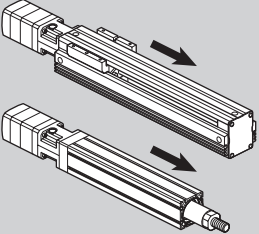
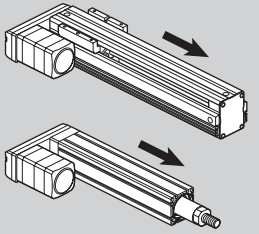
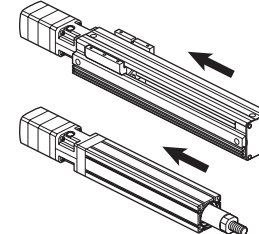
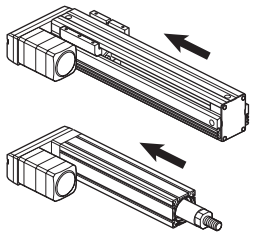
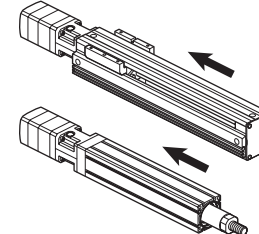
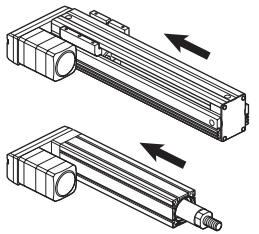
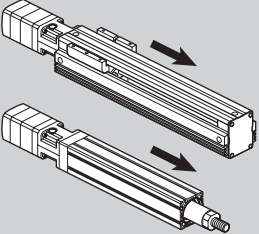
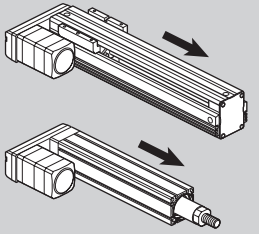
Setting	In-line motor mounting type	Parallel motor mounting type
Operation by setting of parameter When setting the travel amount to the positive (+) side	The table moves to opposite the motor side. 	The table moves to opposite the motor side. 
Operation by pulse signal <ul style="list-style-type: none"> • 2-pulse input mode When inputting the pulse signal to the CW input • 1-pulse input mode When inputting the pulse signal to the PLS input while the DIR input is ON. 		
Operation by setting of parameter When setting the travel amount to the negative (-) side	The table moves to the motor side. 	The table moves to the motor side. 
Operation by pulse signal <ul style="list-style-type: none"> • 2-pulse input mode When inputting the pulse signal to the CCW input. • 1-pulse input mode When inputting the pulse signal to the PLS input while the DIR input is OFF. 		

1-5 Return-to-home operation

Return-to-home is an operation in which the reference point of positioning (home) is detected. It is executed to return to the home from the present position when the time of power-on and upon completion of positioning operation.

■ High-speed return-to-home operation

High-speed return-to-home operation is an operation to return to the mechanical home on the absolute position coordinate set in advance. Since the home is recognized by the ABZO sensor, return-to-home operation can be executed at the same speed as that of the normal positioning operation without using an external sensor. When the ZHOME input is turned ON, high-speed return-to-home operation is started. The motor stops when the operation stop signal is turned ON while the motor is operating.

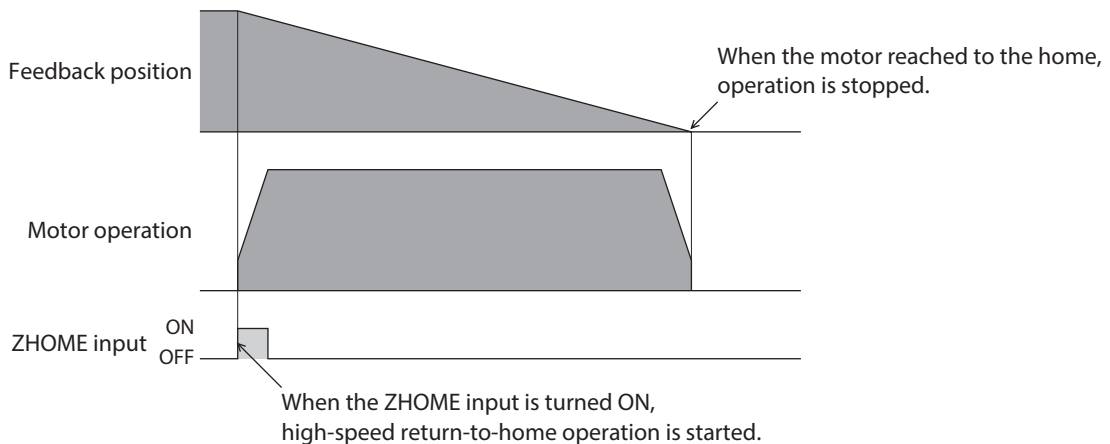

Return-to-home operation

Return-to-home operation is an operation to detect the home by using an external sensor. It is executed to return from the present position to the home at the time of power-on and upon completion of positioning operation. A sensor set is also provided as our product.

Return-to-home operation can be performed in the following four patterns.

Item	Description	Features
2-sensor mode	When the limit sensor is detected, the motor rotates in the reverse direction and pulls out of the limit sensor. After pulling out of the limit sensor, the motor moves to stop according to the value set in the "(HOME) Backward steps in 2 sensor home-seeking" parameter. The position at which the motor stopped becomes the home.	<ul style="list-style-type: none"> Two external sensors are required. The operating speed is low. (return-to-home starting speed)
3-sensor mode	When the limit sensor is detected, the motor rotates in the reverse direction and pulls out of the limit sensor. After that, the motor stops when the ON edge of the HOME sensor is detected. The position at which the motor stopped becomes the home.	<ul style="list-style-type: none"> Three external sensors are required. *2 The operating speed is high. (return-to-home operation speed)
1-sensor mode	The motor stops when the ON edge of the HOME sensor is detected. After that, the motor pulls out at the speed set in the "(HOME) Last speed" parameter until the OFF edge of the HOME sensor is detected. After pulling out of the limit sensor, the motor moves to stop according to the value set in the "(HOME) Operating amount in uni-directional home-seeking" parameter. The position at which the motor stopped becomes the home.	<ul style="list-style-type: none"> One external sensor is required. The operating speed is high. (return-to-home operation speed) Not rotate in the reverse direction.
Push-motion mode *1	The motor rotates in the reverse direction when a mechanism installed to the motor presses against a stopper, etc. on the machine. After that, the motor moves according to the value of "(HOME) Backward steps after first entry in push-home-seeking," rotates in the reverse direction, and is operated at the home detection speed. The motor rotates in the reverse direction when a mechanism installed to the motor presses against a stopper, etc. on the machine, moves according to the value of "(HOME) Backward steps in push-home-seeking," and stops. The position at which the motor stopped becomes the home.	<ul style="list-style-type: none"> An external sensor is not required. The operating speed is high. (return-to-home operation speed)

*1 Do not perform push-motion return-to-home operation with the **EZSH** Series.

*2 When multiple external sensors cannot be installed to a motorized linear actuator and a rotational mechanism, the home can be detected with a single external sensor.

Sensor set

Sensor output	Applicable product		
	EAS Series	EZS Series	EZSH Series
NPN	PAES-S-2X, PAES-S-2Y PAES-S-4X, PAES-S-4Y PAES-S-6X, PAES-S-6Y	PAES-S	PAES-S-6EZSH
PNP	PAES-SY-2X, PAES-SY-2Y PAES-SY-4X, PAES-SY-4Y PAES-SY-6X, PAES-SY-6Y	PAES-SY	PAES-SY-6EZSH

1-6 Push-motion return-to-home operation

⚠ CAUTION

- Perform push-motion return-to-home operation in the specification range of the dynamic permissible moment. Failure to do so may result in injury or damage to equipment.
- **EAC Series:**
If push-motion return-to-home operation is performed in the direction opposite the motor side, provide an external mechanism where the rod can press within the effective stroke. Pressing in excess of the effective stroke may result in injury or damage to equipment.



- Lead 6 mm type products of the **EASM2** or **EACM2** model:
If a load is operated in a vertical direction, perform push-motion return-to-home operation to the downward direction. The home may vary if you perform it to the upward direction.
- Lead 12 mm type products of the **EASM4**, **EZSM4** or **EACM4** model:
If a load is operated in a vertical direction, perform push-motion return-to-home operation to the upward direction with a load mass of 4 kg or less. If the load is exceeded 4 kg, the home may vary.

■ Movement of push-motion return-to-home operation

If push-motion return-to-home operation is performed with keeping the initial value (0) for the “(HOME) Position offset” parameter, the moving part returns to the home to stop after hitting the actuator end. Refer to the “Distance from the actuator end to the home” on p.17.

● EAS/EZS/EAC Series

1. When push-motion return-to-home operation is performed, the moving part moves toward the actuator end.
2. The moving part hits the actuator end.
3. The moving part returns to the set home and stops.

Motorized linear slide

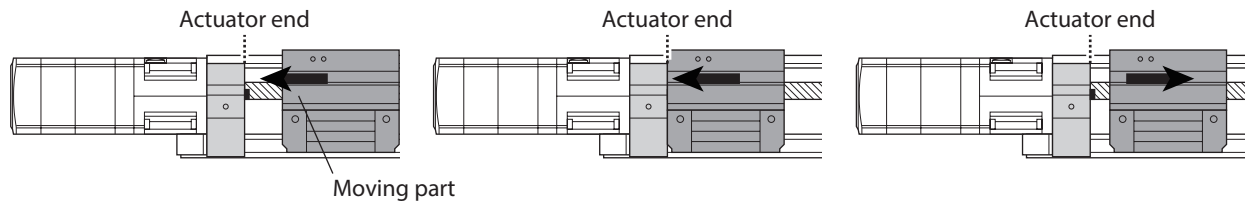

Motorized cylinder

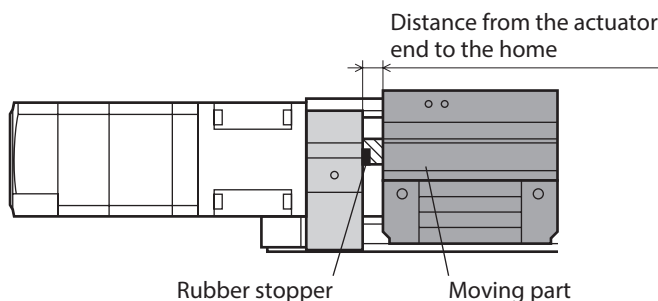
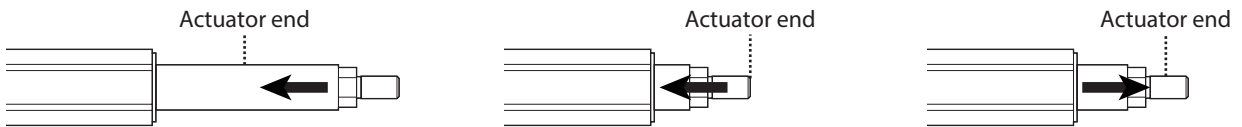

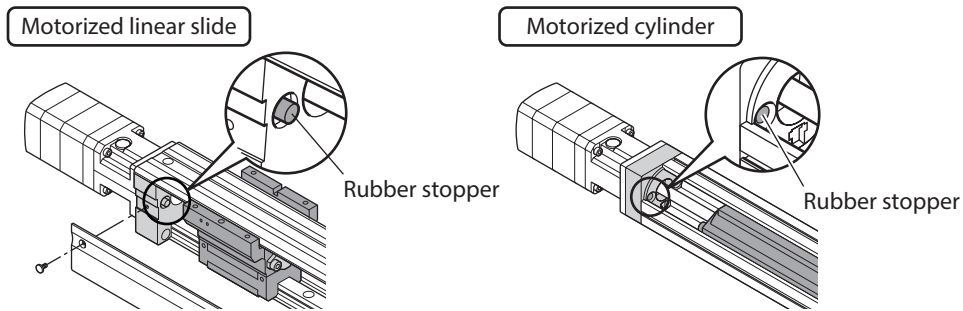

● **Distance from the actuator end to the home**

Series	Model	Distance from the actuator end to the home
EAS	2	4 mm
	4	3 mm
	6	6 mm
EZS	3, 4	3 mm
	6	6 mm
EAC	2, 4, 6	4 mm

■ **Operating current of push-motion return-to-home**

The push force for push-motion return-to-home operation is set in each actuator at the time of shipment.

■ **Operating speed of push-motion return-to-home**

The upper limit value of the push-motion return-to-home speed is shown next.

Series	Lead	Upper limit of push-motion return-to-home speed
EAS EAC	3 mm	25 mm/s
	6 mm	50 mm/s
	12 mm	100 mm/s
EZS	6 mm	50 mm/s
	12 mm	100 mm/s

1-7 Push-motion operation

The push force for push-motion operation is set using the push current. The maximum push force are shown in the table next.

- Motorized linear slide

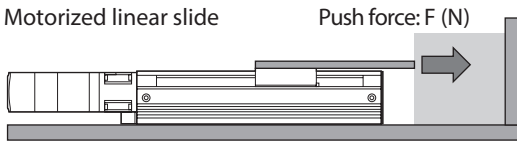

- Motorized cylinder

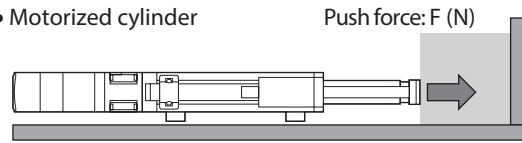

Series	Model	Lead	Push force
EAS EAC	2	3 mm	80 N
		6 mm	40 N
	4	6 mm	200 N
		12 mm	100 N
6	6 mm	500 N	
	12 mm	400 N	
EZS	3, 4	6 mm	200 N
		12 mm	100 N
	6	6 mm	500 N
		12 mm	400 N
EZSH	6	20 mm	325 N
		30 mm	220 N

Note

Be sure to set the push current so that the upper limit value is not exceeded. Performing push-motion operation with the current value exceeding the upper limit value may cause damage to the actuator or equipment. This may also cause deterioration in actuator specification.

Operation data			
	Operation type	Pos. [m/s ²]	Operating current [%]
#0	Absolute push-motion		60.0
#1	Incremental positioning (based on command position)		100.0
#2	Incremental positioning (based on command position)		100.0
#3	Incremental positioning (based on command position)		100.0
#4	Incremental positioning (based on command position)		100.0
#5	Incremental positioning (based on command position)		100.0

1-8 Current setting of push-motion operation

The reference value of the push current is shown next. Check the actual push force using the product.

- Measurement result of the push force when the EAS/EZS/EAC Series is operated in the horizontal direction (average value)

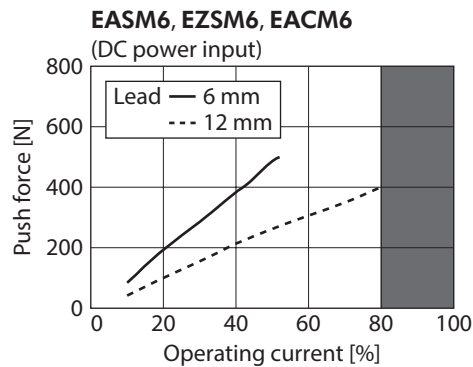
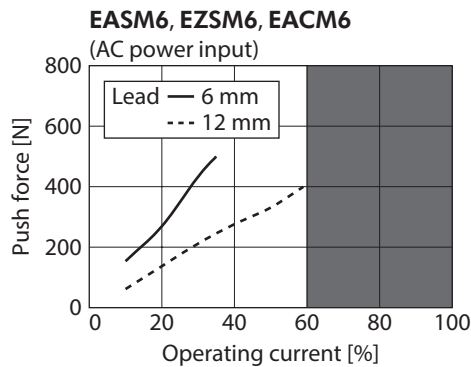
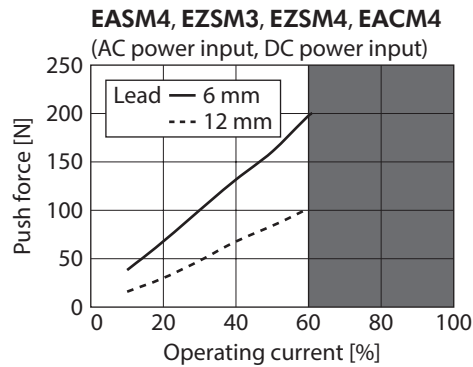
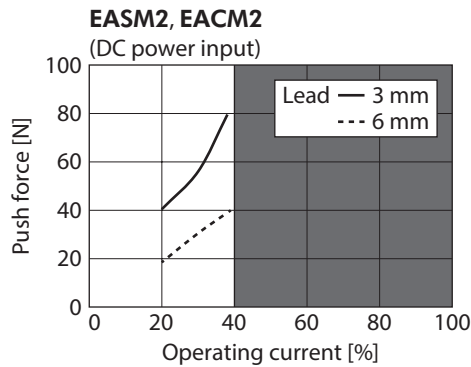

- Measurement result of the push force when the EZSH Series is operated in the horizontal direction (average value)

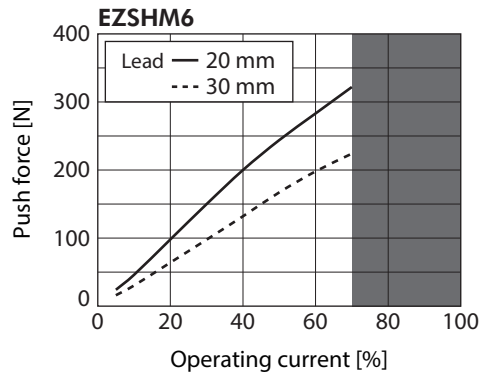

memo The relationship between the push force and push current varies depending on the following conditions. Check the actual push force using the equipment.

- Installation direction of the actuator (horizontal direction installation, vertical direction installation)
- Type of the motorized cylinder (motorized cylinder without a guided-shaft or with guided-shafts, stroke)
- Customer's load condition such as jig
- Cable length
- Ambient temperature

■ Push speed

The upper limit value of the push speed is shown next.

Series	Upper limit of push speed
EAS, EAC, EZS, EZSH	25 mm/s



2 Motorized actuator equipped the AZ Series

3 Motorized actuator equipped the AR Series

◆ Table of contents

1	Setting of the motorized linear slide, motorized cylinder	22
1-1	Setting flow.....	22
1-2	Parameter setting example.....	23
1-3	Traveling direction of the moving part...	33
1-4	Operation setting	34
1-5	Return-to-home operation	36
1-6	Push-motion return-to-home operation	37
1-7	Push-motion operation	40
1-8	Current setting of push-motion operation	41

1 Setting of the motorized linear slide, motorized cylinder

This chapter explains the parameters and operation functions of the motorized linear slide and motorized cylinder. (Hereinafter described as motorized actuator)

1-1 Setting flow

1 Install the motorized actuator.

2 Install and connect a driver.

3 Set parameters for the driver. (It is explained in this part.)

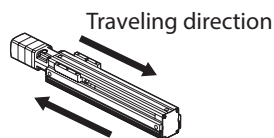
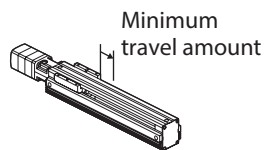
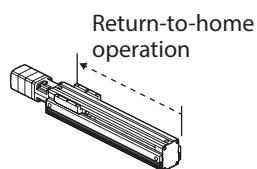

Home operation parameter	
• Home-seeking mode	Push mode
• Starting speed of home-seeking [Hz]	1,000
• Position offset of home-seeking [step]	EAS2, EAC2 200
• Starting direction of home-seeking	Negative direction (Return-to-home operation starts to the motor side)

Coordinates parameter	
• Electronic gear A	10
• Electronic gear B	3
• Motor rotation direction	Positive direction=CW (Moves to opposite the motor side)

4 Completion of setting

■ About the setting file for motorized actuators

The setting file, which the recommended parameters are input in advance to operate the linear slides and cylinders equipped the **AR Series**, is provided in the download page of the **MEXE02**. Download the setting file suitable for the motorized actuator used.

Applicable product: **EAS** Series linear slide, **EZS** Series linear slide, **EZSH** Series linear slide, **EAC** Series cylinder

- memo**
- The setting file is created based on the contents of this manual.
 - The minimum travel amount is 0.01 mm.
 - The positive software limit is not input since it varies depending on the stroke. Input the value of "(stroke × 100) + 300" to the positive software limit before reading the setting file to the driver.

1-2 Parameter setting example

■ Built-in controller type



- Set the starting speed to 6 mm/s or less.
- Set the operating speed by checking the specification of the maximum speed.
- In the case of the motorized actuator of the DC power input type, the operating speed may not reach the maximum speed depending on the ambient temperature or motor cable length.
- AC power input type products of the **EAS6**, **EZS6**, **EZSH6**, or **EAC6** model;
If a load is operated in a vertical direction, an overvoltage alarm may generate depending on the driving condition. When the alarm has generated, reconsider the operating condition or use our regeneration resistor.

● Lead: 3 mm

A setting example of the parameter for when setting the minimum travel amount to 0.01 mm is shown next.

represents parameters to be changed.

Item	Setting example		Initial value *1	
	Setting value	Converted value	Setting value	Converted value
• Lead [mm]	3	–	3	–
• Resolution (Minimum travel amount [mm])	300 (0.01)	–	1,000 (0.003)	–
Operation data				
• Position [step]	1,000	10 [mm]	0	0 [mm]
• Operating speed [Hz]	10,000	100 [mm/s]	1,000	3 [mm/s]
• Acceleration (Deceleration) [ms/kHz] *2	1	10 [m/s ²]	1	3 [m/s ²]
Operation parameter				
• JOG operating speed [Hz]	10,000	100 [mm/s]	1,000	3 [mm/s]
• Acceleration/deceleration rate of JOG [ms/kHz] *2	20	0.5 [m/s ²]	1	3 [m/s ²]
• JOG starting speed [Hz]	600	6 [mm/s]	500	1.5 [mm/s]
Home operation parameter				
• Home-seeking mode	Push mode	–	3-sensor mode	–
• Starting speed of home-seeking [Hz]	1,000	10 [mm/s]	500	1.5 [mm/s]
• Position offset of home-seeking [step]	200	2 [mm]	0	0 [mm]
• Starting direction of home-seeking	Negative direction (Return-to-home operation starts to the motor side)	–	Positive direction (Return-to-home operation starts to opposite the motor side)	–
Coordinates parameter				
• Electronic gear A	10	–	1	–
• Electronic gear B	3	–	1	–
• Motor rotation direction	Positive direction=CW (Moves to opposite the motor side)	–	Positive direction=CW (Moves to opposite the motor side)	–
• Positive software limit [step]	(Stroke × 100) + 300	Stroke + 3 [mm]	8,388,607	25,165.821 [mm]
• Negative software limit [step]	–200	–2 [mm]	–8,388,608	–25,165.824 [mm]

*1 The values are the factory setting data or initialized data.

*2 When setting via RS-485 communication or industrial network, input integral number. Set by increasing the value calculated by the conversion formula to 1,000 times.

- **Lead: 6 mm**

A setting example of the parameter for when setting the minimum travel amount to 0.01 mm is shown next.

□ represents parameters to be changed.

Item	Setting example		Initial value *1	
	Setting value	Converted value	Setting value	Converted value
● Lead [mm]	6	–	6	–
● Resolution (Minimum travel amount [mm])	600 (0.01)	–	1,000 (0.006)	–
Operation data				
● Position [step]	1,000	10 [mm]	0	0 [mm]
● Operating speed [Hz]	10,000	100 [mm/s]	1,000	6 [mm/s]
● Acceleration (Deceleration) [ms/kHz] *2	1	10 [m/s ²]	1	6 [m/s ²]
Operation parameter				
● JOG operating speed [Hz]	10,000	100 [mm/s]	1,000	6 [mm/s]
● Acceleration/deceleration rate of JOG [ms/kHz] *2	20	0.5 [m/s ²]	1	6 [m/s ²]
● JOG starting speed [Hz]	600	6 [mm/s]	500	3 [mm/s]
Home operation parameter				
● Home-seeking mode	Push mode	–	3-sensor mode	–
● Starting speed of home-seeking [Hz]	EAS2, EAC2	1,000	500	3 [mm/s]
	EAS4, EAS6, EAC4, EAC6, EZS3, EZS4, EZS6	2,500	500	3 [mm/s]
● Position offset of home-seeking [step]	EAS2, EAC2, EAC4, EAC6	200	0	0 [mm]
	EZS3, EZS4, EAS4	100		
	EAS6, EZS6	400		
● Starting direction of home-seeking	Negative direction (Return-to-home operation starts to the motor side)	–	Positive direction (Return-to-home operation starts to opposite the motor side)	–
Coordinates parameter				
● Electronic gear A	5	–	1	–
● Electronic gear B	3	–	1	–
● Motor rotation direction *3	Positive direction=CW (Moves to opposite the motor side)	–	Positive direction=CW (Moves to opposite the motor side)	–
● Positive software limit [step]	(Stroke × 100) + 300	Stroke + 3 [mm]	8,388,607	50,331.642 [mm]
● Negative software limit [step]	–200	–2 [mm]	–8,388,608	–50,331.648 [mm]

*1 The values are the factory setting data or initialized data.

*2 When setting via RS-485 communication or industrial network, input integral number. Set by increasing the value calculated by the conversion formula to 1,000 times.

*3 This is the traveling direction of the moving part for the in-line motor mounting type. For the parallel motor mounting type, the moving part moves in the opposite direction of the in-line motor mounting type.

- **Lead: 12 mm**

A setting example of the parameter for when setting the minimum travel amount to 0.01 mm is shown next.

□ represents parameters to be changed.

Item	Setting example		Initial value *1	
	Setting value	Converted value	Setting value	Converted value
● Lead [mm]	12	–	12	–
● Resolution (Minimum travel amount [mm])	1,200 (0.01)	–	1,000 (0.012)	–
Operation data				
● Position [step]	1,000	10 [mm]	0	0 [mm]
● Operating speed [Hz]	10,000	100 [mm/s]	1,000	12 [mm/s]
● Acceleration (Deceleration) [ms/kHz] *2	1	10 [m/s ²]	1	12 [m/s ²]
Operation parameter				
● JOG operating speed [Hz]	10,000	100 [mm/s]	1,000	12 [mm/s]
● Acceleration/deceleration rate of JOG [ms/kHz] *2	20	0.5 [m/s ²]	1	12 [m/s ²]
● JOG starting speed [Hz]	600	6 [mm/s]	500	6 [mm/s]
Home operation parameter				
● Home-seeking mode	Push mode	–	3-sensor mode	–
● Starting speed of home-seeking [Hz]	2,500	25 [mm/s]	500	6 [mm/s]
● Position offset of home-seeking [step]	EAC4, EAC6	200	0	0 [mm]
	EZS3, EZS4, EAS4	100		
	EAS6, EZS6	400		
● Starting direction of home-seeking	Negative direction (Return-to-home operation starts to the motor side)	–	Positive direction (Return-to-home operation starts to opposite the motor side)	–
Coordinates parameter				
● Electronic gear A	5	–	1	–
● Electronic gear B	6	–	1	–
● Motor rotation direction *3	Positive direction=CW (Moves to opposite the motor side)	–	Positive direction=CW (Moves to opposite the motor side)	–
● Positive software limit [step]	(Stroke × 100) + 300	Stroke + 3 [mm]	8,388,607	100,663.284 [mm]
● Negative software limit [step]	–200	–2 [mm]	–8,388,608	–100,663.296 [mm]

*1 The values are the factory setting data or initialized data.

*2 When setting via RS-485 communication or industrial network, input integral number. Set by increasing the value calculated by the conversion formula to 1,000 times.

*3 This is the traveling direction of the moving part for the in-line motor mounting type. For the parallel motor mounting type, the moving part moves in the opposite direction of the in-line motor mounting type.

● **Lead: 20 mm**

A setting example of the parameter for when setting the minimum travel amount to 0.01 mm is shown next.

represents parameters to be changed.

Item	Setting example		Initial value *1	
	Setting value	Converted value	Setting value	Converted value
● Lead [mm]	20	–	20	–
● Resolution (Minimum travel amount [mm])	2,000 (0.01)	–	1,000 (0.02)	–
Operation data				
● Position [step]	1,000	10 [mm]	0	0 [mm]
● Operating speed [Hz]	10,000	100 [mm/s]	1,000	20 [mm/s]
● Acceleration (Deceleration) [ms/kHz] *2	1	10 [m/s ²]	1	20 [m/s ²]
Operation parameter				
● JOG operating speed [Hz]	10,000	100 [mm/s]	1,000	20 [mm/s]
● Acceleration/deceleration rate of JOG [ms/kHz] *2	1	10 [m/s ²]	1	20 [m/s ²]
● JOG starting speed [Hz]	600	6 [mm/s]	500	10 [mm/s]
Home operation parameter				
● Home-seeking mode	3-sensor mode	–	3-sensor mode	–
● Starting speed of home-seeking [Hz]	2,500	25 [mm/s]	500	10 [mm/s]
● Starting direction of home-seeking	Negative direction (Return-to-home operation starts to the motor side)	–	Positive direction (Return-to-home operation starts to opposite the motor side)	–
Coordinates parameter				
● Electronic gear A	1	–	1	–
● Electronic gear B	2	–	1	–
● Motor rotation direction	Positive direction=CW (Moves to opposite the motor side)	–	Positive direction=CW (Moves to opposite the motor side)	–
● Positive software limit [step]	(Stroke × 100) + 300	Stroke + 3 [mm]	8,388,607	167,772.14 [mm]
● Negative software limit [step]	–200	–2 [mm]	–8,388,608	–167,772.16 [mm]

*1 The values are the factory setting data or initialized data.

*2 When setting via RS-485 communication or industrial network, input integral number. Set by increasing the value calculated by the conversion formula to 1,000 times.

● Lead: 30 mm

A setting example of the parameter for when setting the minimum travel amount to 0.01 mm is shown next.

represents parameters to be changed.

DANGER

- Do not enter the moving range of the product while the power is supplied. Be sure to provide a safety cage according to EN ISO13857. If the motorized linear slide moved to unexpected directions or ran at unexpected speeds during operation, serious injury may result.
- Operate the data setter outside the safety cage. Failure to do so may result in injury.

● Item	Setting example		Initial value *1	
	Setting value	Converted value	Setting value	Converted value
● Lead [mm]	30	–	30	–
● Resolution (Minimum travel amount [mm])	3,000 (0.01)	–	1,000 (0.03)	–
Operation data				
● Position [step]	1,000	10 [mm]	0	0 [mm]
● Operating speed [Hz]	10,000	100 [mm/s]	1,000	30 [mm/s]
● Acceleration (Deceleration) [ms/kHz] *2	1	10 [m/s ²]	1	30 [m/s ²]
Operation parameter				
● JOG operating speed [Hz]	10,000	100 [mm/s]	1,000	30 [mm/s]
● Acceleration/deceleration rate of JOG [ms/kHz] *2	1	10 [m/s ²]	1	30 [m/s ²]
● JOG starting speed [Hz]	600	6 [mm/s]	500	15 [mm/s]
Home operation parameter				
● Home-seeking mode	3-sensor mode	–	3-sensor mode	–
● Starting speed of home-seeking [Hz]	2,500	25 [mm/s]	500	15 [mm/s]
● Starting direction of home-seeking	Negative direction (Return-to-home operation starts to the motor side)	–	Positive direction (Return-to-home operation starts to opposite the motor side)	–
Coordinates parameter				
● Electronic gear A	1	–	1	–
● Electronic gear B	3	–	1	–
● Motor rotation direction	Positive direction=CW (Moves to opposite the motor side)	–	Positive direction=CW (Moves to opposite the motor side)	–
● Positive software limit [step]	(Stroke × 100) + 300	Stroke + 3 [mm]	8,388,607	251,658.21 [mm]
● Negative software limit [step]	–200	–2 [mm]	–8,388,608	–251,658.24 [mm]

*1 The values are the factory setting data or initialized data.

*2 When setting via RS-485 communication or industrial network, input integral number. Set by increasing the value calculated by the conversion formula to 1,000 times.

■ Pulse input type



- Set the starting speed to 6 mm/s or less.
- Set the operating speed by checking the specification of the maximum speed.
- In the case of the motorized actuator of the DC power input type, the operating speed may not reach the maximum speed depending on the ambient temperature or motor cable length.
- AC power input type products of the **EAS6**, **EZS6**, **EZSH6** or **EAC6** model;
If a load is operated in a vertical direction, an overvoltage alarm may generate depending on the driving condition. When the alarm has generated, reconsider the operating condition or use our regeneration resistor.

● Lead: 3 mm

A setting example of the parameter for when setting the minimum travel amount to 0.01 mm is shown next.
 represents parameters to be changed.

Item	Setting example		Initial value *	
	Setting value	Converted value	Setting value	Converted value
• Lead [mm]	3	–	3	–
• Resolution (Minimum travel amount [mm])	300 (0.01)	–	1,000 (0.003)	–
Return to electrical home operation parameter				
• Operating speed of return to electrical home operation [r/min]	2,000	100 [mm/s]	30	3 [mm/s]
• Acceleration/deceleration rate of return to electrical home operation [ms/(1,000 r/min)]	100	0.5 [m/s ²]	100	0.5 [m/s ²]
• Starting speed of return operation [r/min]	120	6 [mm/s]	30	3 [mm/s]
Manual operation parameter				
• JOG operating speed [r/min]	2,000	100 [mm/s]	30	3 [mm/s]
• Acceleration and deceleration rate of JOG operation [ms/(1,000 r/min)]	100	0.5 [m/s ²]	100	0.5 [m/s ²]
• Starting speed of JOG operation [r/min]	120	6 [mm/s]	30	3 [mm/s]
Electronic gear parameter				
• Electronic gear A1	10	–	10	–
• Electronic gear B	3	–	10	–
Operation parameter				
• Motor rotation direction	Positive=CW (Moves to opposite the motor side)	–	Positive=CW (Moves to opposite the motor side)	–

* The values are the factory setting data or initialized data.

- **Lead: 6 mm**

A setting example of the parameter for when setting the minimum travel amount to 0.01 mm is shown next.

represents parameters to be changed.

Item	Setting example		Initial value *1	
	Setting value	Converted value	Setting value	Converted value
● Lead [mm]	6	–	6	–
● Resolution (Minimum travel amount [mm])	600 (0.01)	–	1,000 (0.006)	–
Return to electrical home operation parameter				
● Operating speed of return to electrical home operation [r/min]	1,000	100 [mm/s]	30	3 [mm/s]
● Acceleration/deceleration rate of return to electrical home operation [ms/(1,000 r/min)]	200	0.5 [m/s ²]	100	1 [m/s ²]
● Starting speed of return operation [r/min]	60	6 [mm/s]	30	3 [mm/s]
Manual operation parameter				
● JOG operating speed [r/min]	1,000	100 [mm/s]	30	3 [mm/s]
● Acceleration and deceleration rate of JOG operation [ms/(1,000 r/min)]	200	0.5 [m/s ²]	100	1 [m/s ²]
● Starting speed of JOG operation [r/min]	60	6 [mm/s]	30	3 [mm/s]
Electronic gear parameter				
● Electronic gear A1	5	–	10	–
● Electronic gear B	3	–	10	–
Operation parameter				
● Motor rotation direction *2	Positive=CW (Moves to opposite the motor side)	–	Positive=CW (Moves to opposite the motor side)	–

*1 The values are the factory setting data or initialized data.

*2 This is the traveling direction of the moving part for the in-line motor mounting type. For the parallel motor mounting type, the moving part moves in the opposite direction of the in-line motor mounting type.

● **Lead: 12 mm**

A setting example of the parameter for when setting the minimum travel amount to 0.01 mm is shown next.

represents parameters to be changed.

Item	Setting example		Initial value *1	
	Setting value	Converted value	Setting value	Converted value
● Lead [mm]	12	–	12	–
● Resolution (Minimum travel amount [mm])	1,200 (0.01)	–	1,000 (0.012)	–
Return to electrical home operation parameter				
● Operating speed of return to electrical home operation [r/min]	500	100 [mm/s]	30	6 [mm/s]
● Acceleration/deceleration rate of return to electrical home operation [ms/(1,000 r/min)]	400	0.5 [m/s ²]	100	2 [m/s ²]
● Starting speed of return operation [r/min]	30	6 [mm/s]	30	6 [mm/s]
Manual operation parameter				
● JOG operating speed [r/min]	500	100 [mm/s]	30	6 [mm/s]
● Acceleration and deceleration rate of JOG operation [ms/(1,000 r/min)]	400	0.5 [m/s ²]	100	2 [m/s ²]
● Starting speed of JOG operation [r/min]	30	6 [mm/s]	30	6 [mm/s]
Electronic gear parameter				
● Electronic gear A1	5	–	10	–
● Electronic gear B	6	–	10	–
Operation parameter				
● Motor rotation direction *2	Positive=CW (Moves to opposite the motor side)	–	Positive=CW (Moves to opposite the motor side)	–

*1 The values are the factory setting data or initialized data.

*2 This is the traveling direction of the moving part for the in-line motor mounting type. For the parallel motor mounting type, the moving part moves in the opposite direction of the in-line motor mounting type.

● **Lead: 20 mm**

A setting example of the parameter for when setting the minimum travel amount to 0.01 mm is shown next.

represents parameters to be changed.

Item	Setting example		Initial value *	
	Setting value	Converted value	Setting value	Converted value
● Lead [mm]	20	–	20	–
● Resolution (Minimum travel amount [mm])	2,000 (0.01)	–	1,000 (0.02)	–
Return to electrical home operation parameter				
● Operating speed of return to electrical home operation [r/min]	300	100 [mm/s]	30	10 [mm/s]
● Acceleration/deceleration rate of return to electrical home operation [ms/(1,000 r/min)]	166.6	2 [m/s ²]	100	3.33 [m/s ²]
● Starting speed of return operation [r/min]	18	6 [mm/s]	30	10 [mm/s]
Manual operation parameter				
● JOG operating speed [r/min]	300	100 [mm/s]	30	10 [mm/s]
● Acceleration and deceleration rate of JOG operation [ms/(1,000 r/min)]	166.6	2 [m/s ²]	100	3.33 [m/s ²]
● Starting speed of JOG operation [r/min]	18	6 [mm/s]	30	10 [mm/s]
Electronic gear parameter				
● Electronic gear A1	1	–	10	–
● Electronic gear B	2	–	10	–
Operation parameter				
● Motor rotation direction	Positive=CW (Moves to opposite the motor side)	–	Positive=CW (Moves to opposite the motor side)	–

* The values are the factory setting data or initialized data.

● **Lead: 30 mm**

A setting example of the parameter for when setting the minimum travel amount to 0.01 mm is shown next.
 represents parameters to be changed.



- Do not enter the moving range of the product while the power is supplied. Be sure to provide a safety cage according to EN ISO13857. If the motorized linear slide moved to unexpected directions or ran at unexpected speeds during operation, serious injury may result.
- Operate the data setter outside the safety cage. Failure to do so may result in injury.

Item	Setting example		Initial value *	
	Setting value	Converted value	Setting value	Converted value
• Lead [mm]	30	–	30	–
• Resolution (Minimum travel amount [mm])	3,000 (0.01)	–	1,000 (0.03)	–
Return to electrical home operation parameter				
• Operating speed of return to electrical home operation [r/min]	200	100 [mm/s]	30	15 [mm/s]
• Acceleration/deceleration rate of return to electrical home operation [ms/(1,000 r/min)]	250	2 [m/s ²]	100	5 [m/s ²]
• Starting speed of return operation [r/min]	12	6 [mm/s]	30	15 [mm/s]
Manual operation parameter				
• JOG operating speed [r/min]	200	100 [mm/s]	30	15 [mm/s]
• Acceleration and deceleration rate of JOG operation [ms/(1,000 r/min)]	250	2 [m/s ²]	100	5 [m/s ²]
• Starting speed of JOG operation [r/min]	12	6 [mm/s]	30	15 [mm/s]
Electronic gear parameter				
• Electronic gear A1	1	–	10	–
• Electronic gear B	3	–	10	–
Operation parameter				
• Motor rotation direction	Positive=CW (Moves to opposite the motor side)	–	Positive=CW (Moves to opposite the motor side)	–

* The values are the factory setting data or initialized data.

1-3 Traveling direction of the moving part

The traveling direction of the moving part varies depending on the setting of the travel amount or the input method of the pulse signal.

WARNING

Set various parameters such as the resolution and traveling direction before operating the motorized actuator. Operating the actuator without setting parameters may cause it to move to unexpected directions or run at unexpected speeds, leading to injury or damage to equipment.

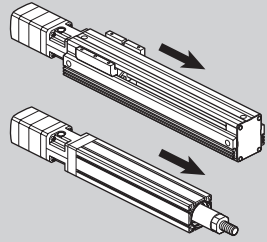
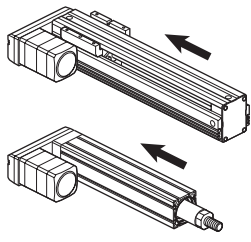
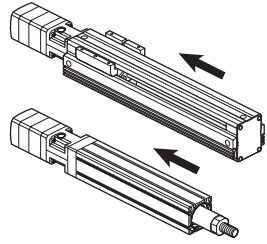
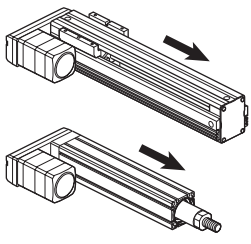
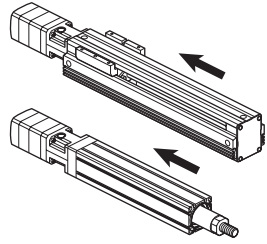
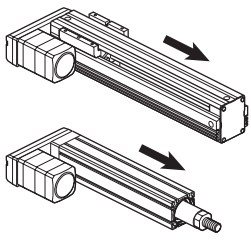
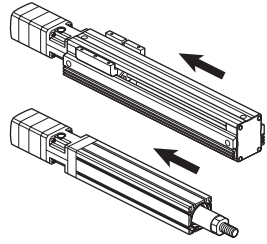
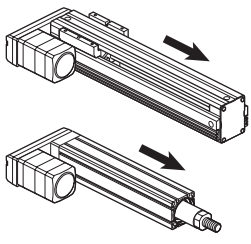
Setting	In-line motor mounting type	Parallel motor mounting type
Operation by setting of parameter When setting the travel amount to the positive (+) side	The table moves to opposite the motor side. 	The table moves to the motor side. 
Operation by pulse signal <ul style="list-style-type: none"> • 2-pulse input mode When inputting the pulse signal to the CW input • 1-pulse input mode When inputting the pulse signal to the PLS input while the DIR input is ON. 		
Operation by setting of parameter When setting the travel amount to the negative (-) side	The table moves to the motor side. 	The table moves to opposite the motor side. 
Operation by pulse signal <ul style="list-style-type: none"> • 2-pulse input mode When inputting the pulse signal to the CCW input. • 1-pulse input mode When inputting the pulse signal to the PLS input while the DIR input is OFF. 		

1-4 Operation setting

When the minimum travel amount, travel amount, operating speed, and acceleration/deceleration speed are set to the driver for the motorized actuator, the following calculation is required. This section explains the motorized linear slide as an example.

⚠ WARNING

Set various parameters such as the resolution and traveling direction before operating the motorized actuator. Operating the actuator without setting parameters may cause it to move to unexpected directions or run at unexpected speeds, leading to injury or damage to equipment.

■ Minimum travel amount

The minimum travel amount can be changed using the driver switch or parameters. (electronic gear A, electronic gear B)

$$\text{Minimum travel amount (mm)} = \frac{\text{Ball screw lead (mm)}}{\text{Motor resolution (P/R)}}$$

$$\text{Motor resolution (P/R)} = 1,000 \times (\text{Electronic gear B} \div \text{Electronic gear A})$$

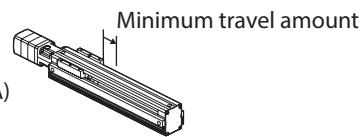

● Setting example:

When setting the minimum travel amount to 0.01 mm for 6 mm lead of the motorized linear slide

$$\text{Minimum travel amount (mm)} = \frac{6 \text{ mm}}{\text{Motor resolution (P/R)}} = 0.01 \text{ mm}$$

$$\text{Motor resolution (P/R)} = \frac{6 \text{ mm}}{0.01 \text{ mm}} = 600 \text{ P/R}$$

$$\text{Motor resolution (P/R)} = 1,000 \times (\text{Electronic gear B} \div \text{Electronic gear A}) = 600 \text{ P/R}$$

$$\frac{\text{Electronic gear B}}{\text{Electronic gear A}} = \frac{600}{1,000} = \frac{3}{5}$$

When setting the minimum travel amount to 0.01 mm, set the electronic gear A to 5 and the electronic gear B to 3.

Lead	Minimum travel amount	Motor resolution	Electronic gear A	Electronic gear B
3 mm	0.01 mm	300 P/R	10	3
6 mm	0.01 mm	600 P/R	5	3
12 mm	0.01 mm	1,200 P/R	5	6
20 mm	0.01 mm	2,000 P/R	1	2
30 mm	0.01 mm	3,000 P/R	1	3

■ Travel amount

The travel amount is set by number of pulses. For the built-in controller type, the position (step) is used instead of number of pulses.

$$\text{Travel amount (mm)} = \text{Number of pulses (pulse)} \times \text{Minimum travel amount (mm)}$$

● Setting example:

When the motorized linear slide which minimum travel amount is set to 0.01 mm is moved by 30 mm

$$\text{Travel amount (mm)} = \text{Number of pulses (pulse)} \times 0.01 \text{ mm} = 30 \text{ mm}$$

$$\text{Number of pulses (pulse)} = \frac{30 \text{ mm}}{0.01 \text{ mm}} = 3,000 \text{ pulses}$$

When moving the motorized linear slide by 30 mm, set 3,000 pulses.

■ Operating speed

The operating speed is set by the pulse speed. For the built-in controller type, the operating speed (Hz) is used instead of pulse speed.

$$\text{Operating speed (mm/s)} = \text{Pulse speed (Hz)} \times \text{Minimum travel amount (mm)}$$

● Setting example:

When the motorized linear slide which minimum travel amount is set to 0.01 mm is moved at the operating speed of 50 mm/s

$$\text{Operating speed (mm/s)} = \text{Pulse speed (Hz)} \times 0.01 \text{ mm} = 50 \text{ mm/s}$$

$$\text{Pulse speed (Hz)} = \frac{50 \text{ mm/s}}{0.01 \text{ mm}} = 5,000 \text{ Hz}$$

When moving the motorized linear slide at the operating speed of 50 mm/s, set 5,000 Hz.

■ Acceleration/deceleration speed

The acceleration/deceleration speed is set by any of the acceleration/deceleration rate (ms/kHz), acceleration/deceleration rate [ms/(1,000 r/min)] or acceleration/deceleration time (s).

$$\text{Acceleration/deceleration speed (m/s}^2\text{)} = \frac{\text{Minimum travel amount (mm)} \times 1,000}{\text{Acceleration/deceleration rate (ms/kHz)}}$$

$$\text{Acceleration/deceleration speed (m/s}^2\text{)} = \frac{\text{Lead (mm)} \times 1,000}{60 \times \text{Acceleration/deceleration rate [ms/(1,000 r/min)]}}$$

$$\text{Acceleration/deceleration speed (m/s}^2\text{)} = \frac{\text{Operating speed (mm/s)}}{\text{Acceleration/deceleration time (s)}}$$

● Setting example:

When the motorized linear slide which minimum travel amount is set to 0.01 mm is moved at the operating speed of 10 m/s²

$$\text{Acceleration/deceleration speed (m/s}^2\text{)} = \frac{0.01 \text{ mm} \times 1,000}{\text{Acceleration/deceleration rate (ms/kHz)}} = 10 \text{ m/s}^2$$

$$\text{Acceleration/deceleration rate (ms/kHz)} = \frac{0.01 \text{ mm} \times 1,000}{10 \text{ m/s}^2} = 1 \text{ ms/kHz}$$

When moving the motorized linear slide at the acceleration/deceleration speed of 10 m/s², set 1 ms/kHz.

1-5 Return-to-home operation

Return-to-home is an operation in which the reference point of positioning (home) is detected. It is executed to return to the home from the present position when the time of power-on and upon completion of positioning operation.

■ Built-in controller type

For details, refer to the user manual of the built-in controller type. A sensor set is also provided as our product.

Item	Description	Features
3-sensor mode	The motor operates at the "operating speed of home-seeking." When the ON edge of the HOME sensor is detected, the motor will stop and the stop position will be the home.	<ul style="list-style-type: none"> • Three external sensors are required. *4 • The operating speed is high. (operating speed of home-seeking)
2-sensor mode	The motor operates at the "starting speed of home-seeking." When the limit sensor is detected, the motor will rotate in the reverse direction and escape from the limit sensor. After escaping from the limit sensor, the motor will move 200 steps and stop, and then the stop position will be the home. *3	<ul style="list-style-type: none"> • Two external sensors are required. • The operating speed is low. (starting speed of home-seeking)
Push mode *1 *2	The motor operates at the "starting speed of home-seeking." When the moving part for the motor is pressed against a mechanical stopper etc., the motor will rotate in the reverse direction. After reversing, the motor will move 200 steps and stop, and then the stop position will be the home. *3	<ul style="list-style-type: none"> • No external sensor is required. • The operating speed is low. (starting speed of home-seeking)
Position preset	When executing the P-PRESET at the position that the motor stops, the command position will be the value of the "Preset position" parameter. The home can be set to any position.	<ul style="list-style-type: none"> • No external sensor is required. • The home can be set to any position.

*1 The offset setting is required according to an actuator.

*2 Do not perform push-motion return-to-home operation with the **EZSH** Series.

*3 It moves 200 steps regardless of resolution. Therefore, the actual travel distance may vary according to resolution.

*4 When multiple external sensors cannot be installed, the home can be detected with a single external sensor. In this case, connect the HOME sensor.

Sensor set

Sensor output	Applicable product		
	EAS Series	EZS Series	EZSH Series
NPN	PAES-S-2X, PAES-S-2Y PAES-S-4X, PAES-S-4Y PAES-S-6X, PAES-S-6Y	PAES-S	PAES-S-6EZSH
PNP	PAES-SY-2X, PAES-SY-2Y PAES-SY-4X, PAES-SY-4Y PAES-SY-6X, PAES-SY-6Y	PAES-SY	PAES-SY-6EZSH

■ Pulse input type

For details, refer to the user manual of the pulse input type.

Item	Description	Features
Return to electrical home operation	When the RETURN input is turned ON, the motor will start a return to electrical home operation. The electrical home (position) refers to the motor position effective when the driver power is turned on, or the position when the P-PRESET input is turned ON.	<ul style="list-style-type: none"> • No external sensor is required. • The home can be set to any position.

1-6 Push-motion return-to-home operation

Push-motion return-to-home operation can be performed when the built-in controller type is used.

CAUTION

- Perform push-motion return-to-home operation in the specification range of the dynamic permissible moment. Failure to do so may result in injury or damage to equipment.
- **EAC Series:**
If push-motion return-to-home operation is performed in the direction opposite the motor side, provide an external mechanism where the rod can press within the effective stroke. Pressing in excess of the effective stroke may result in injury or damage to equipment.

memo

- Set the value of the "position offset of home-seeking" for when performing push-motion operation to be larger than the "distance from the actuator end to the home." If push-motion return-to-home operation is performed with keeping the initial value (0), the moving part becomes a state of contacting the stop buffer that is installed for the impact buffer, leading to a negative effect on the stopping accuracy of return-to-home.
- Lead 6 mm type products of the **EAS2** or **EAC2** model:
If a load is operated in a vertical direction, perform push-motion return-to-home operation to the downward direction. The home may vary if you perform it to the upward direction.
- Lead 12 mm type products of the **EAS4**, **EZS4** or **EAC4** model:
If a load is operated in a vertical direction, perform push-motion return-to-home operation to the upward direction with a load mass of 4 kg or less. If the load is exceeded 4 kg, the home may vary.

■ Movement of push-motion return-to-home operation

If push-motion return-to-home operation is performed with keeping the initial value (0) for the "Position offset of home-seeking" parameter, the position, where the moving part moves 200 steps in the reverse direction after pressing against the actuator end and stops, will be determined as the home.

1. When push-motion return-to-home operation is performed, the moving part moves toward the actuator end.
2. The moving part hits the actuator end.
3. The moving part moves 200 steps in the reverse direction and stops.

Motorized linear slide

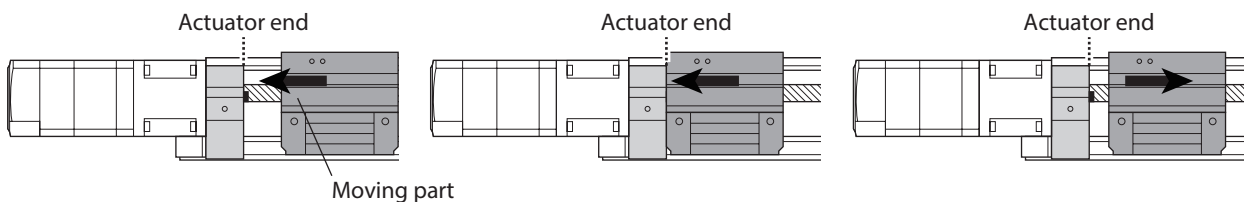

Motorized cylinder

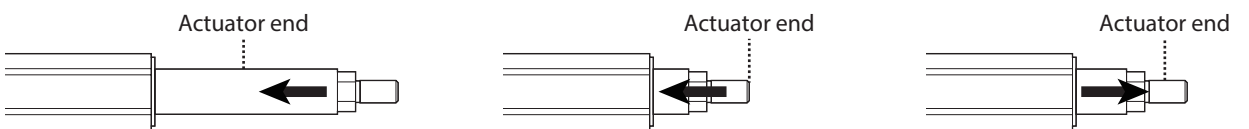

Operation data		Home operation
Home-seeking mode		Push mode
Operating speed of home-seeking [Hz]		1000
Acceleration/deceleration of home-seeking [ms/kHz] or [s]		1.000
Starting speed of home-seeking [Hz]		500
Position offset of home-seeking [step]		0
Starting direction of home-seeking		Positive direction
SLIT detection with home-seeking		Disable
TIM signal detection with home-seeking		Disable
Operating current of home-seeking with push-motion [%]		100.0

The motor moves 200 steps in the reverse direction and stops even if the setting is the initial value (0).

■ Position offset of push-motion return-to-home operation

Set the value of the "position offset of home-seeking" for when performing push-motion operation to be larger than the "distance from the actuator end to the home." If push-motion return-to-home operation is performed with keeping the initial value (0), the moving part becomes a state of contacting the stop buffer that is installed for the impact buffer, leading to a negative effect on the stopping accuracy of return-to-home.

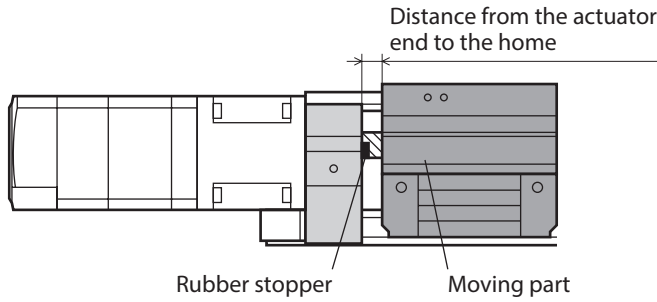

Series	Model	Distance from the actuator end to the home
EAS	2	4 mm
	4	3 mm
	6	6 mm
EZS	3, 4	3 mm
	6	6 mm
EAC	2, 4, 6	4 mm

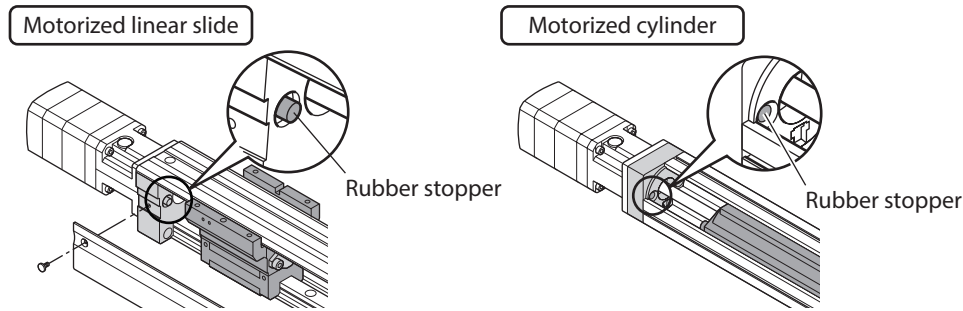

Setting example:

When the distance from the actuator end to the home is set to 3 mm while the minimum travel amount of the motorized linear slide is 0.01 mm

Distance from the actuator end to the home (mm) = [200 + offset value] (step) × 0.01 mm = 3 mm
Therefore, offset value = 100 steps

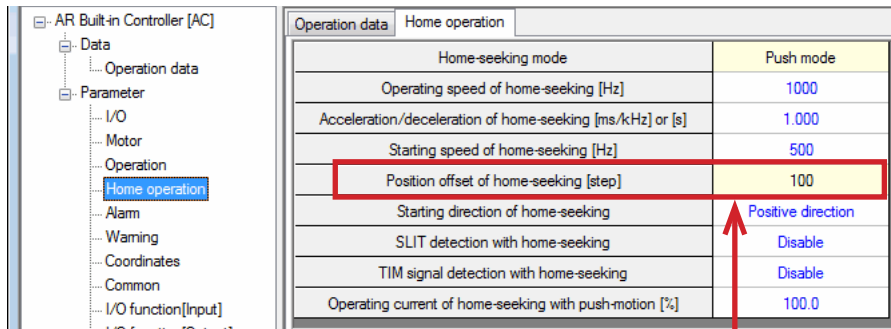

If the "Position offset of home-seeking" is set to 100 steps, the motor moves 300 steps (3 mm) in the reverse direction and stops.

■ Operating speed of push-motion return-to-home operation

The upper limit value of the push-motion return-to-home speed is shown next.

Series	Model	Upper limit of push-motion return-to-home speed
EAS	2	10 mm/s
	4, 6	25 mm/s
EAC	2	10 mm/s
	4, 6	25 mm/s
EZS	3, 4, 6	25 mm/s

■ Setting of the operating current of push-motion return-to-home operation (push force)

When performing push-motion return-to-home operation, you can set the push force to the actuator end using the "Operating current of home-seeking with push-motion" parameter. Set according to the recommended value in the table next.

Note Be sure to set the operating current of push-motion return-to-home operation to less than the recommended value. Performing push-motion return-to-home operation with the current value exceeding the recommended value may cause damage to the actuator or equipment. This may also cause deterioration in actuator specification.

1. When push-motion return-to-home operation is performed, the moving part moves toward the actuator end.
2. The moving part hits the actuator end. The push force can be changed by adjusting the operating current of push-motion return-to-home operation.

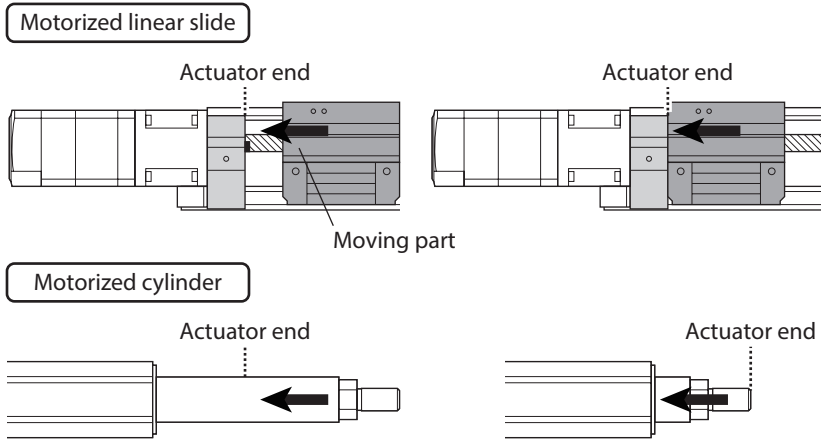

● Recommended value for operating current of push-motion return-to-home operation

AC power input type

Series	Model	Lead	Operating current of push-motion return-to-home operation
EAS	4	6 mm, 12 mm	100%
	6	6 mm	55%
		12 mm	85%
EAC	4	6 mm, 12 mm	100%
	6	6 mm	55%
		12 mm	85%
EZX	3, 4	6 mm, 12 mm	100%
	6	6 mm	55%
		12 mm	85%

DC power input type

Series	Model	Lead	Operating current of push-motion return-to-home operation
EAS	2	3 mm, 6 mm	100%
		6 mm, 12 mm	100%
	6	6 mm	80%
		12 mm	100%
EAC	2	3 mm, 6 mm	100%
		6 mm, 12 mm	100%
	6	6 mm	80%
		12 mm	100%
EZS	3, 4	6 mm, 12 mm	100%
		6 mm	80%
	6	12 mm	100%

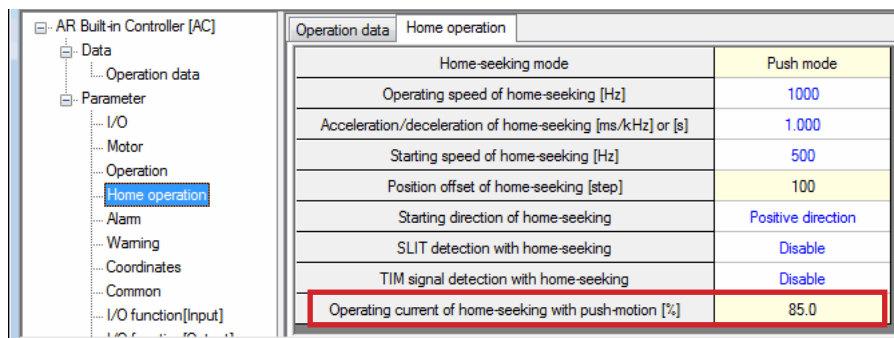

1-7 Push-motion operation

The push force for push-motion operation is set using the push current.

Note Be sure to set the push current so that the upper limit value is not exceeded. Performing push-motion operation with the current value exceeding the upper limit value may cause damage to the actuator or equipment. This may also cause deterioration in actuator specification.



Series	Model	Lead	Maximum push force
EAS EAC	2	3 mm	80 N
		6 mm	40 N
	4	6 mm	200 N
		12 mm	100 N
EZS	3, 4	6 mm	200 N
		12 mm	100 N
	6	6 mm	500 N
		12 mm	400 N
EZSH	6	20 mm	325 N
		30 mm	220 N

Operation data		Home operation			
	Operation mode	Position [step]	Operating speed [Hz]	Operation function	Push current [%]
#0	Incremental (INC)	0	1000	Single-motion	20.0
#1	Incremental (INC)	0	1000	Single-motion	20.0
#2	Incremental (INC)	0	1000	Single-motion	20.0
#3	Incremental (INC)	0	1000	Single-motion	20.0
#4	Incremental (INC)	0	1000	Single-motion	20.0
#5	Incremental (INC)	0	1000	Single-motion	20.0
#6	Incremental (INC)	0	1000	Single-motion	20.0

1-8 Current setting of push-motion operation

The reference value of the push current is shown next. Check the actual push force using the product.



The relationship between the push force and push current varies depending on the following conditions. Check the actual push force using the equipment.

- Installation direction of the actuator (horizontal direction installation, vertical direction installation)
- Type of the motorized cylinder (motorized cylinder without a guided-shaft or with guided-shafts, stroke)
- Customer's load condition such as jig
- Cable length
- Ambient temperature

- Measurement result of the push force when the EAS/EZS/EAC Series is operated in the horizontal direction (average value)

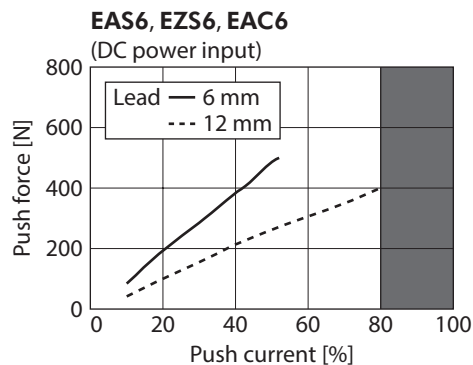
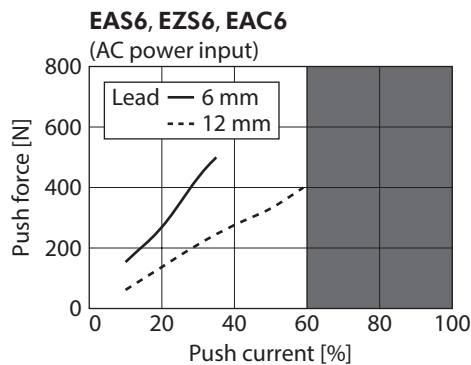
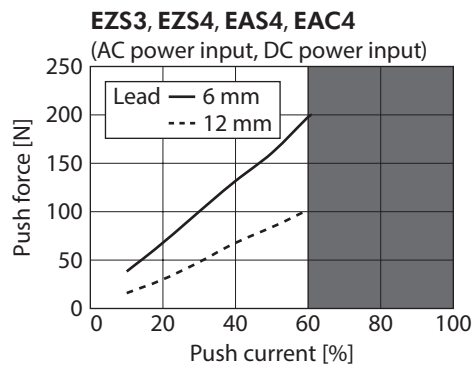
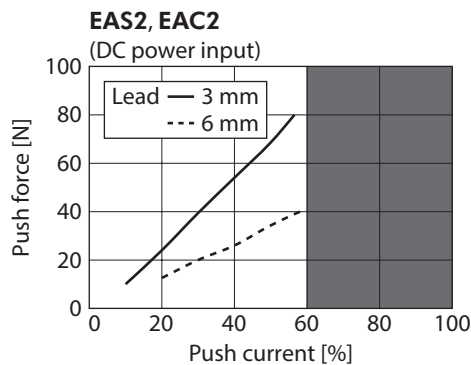

- Measurement result of the push force when the EZSH Series is operated in the horizontal direction (average value)

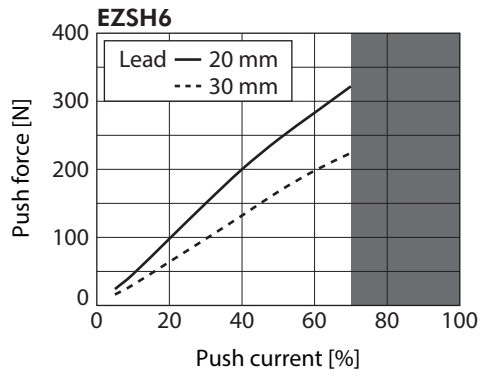

■ Push speed

The upper limit value of the push speed is shown next.

Series	Model	Upper limit of push speed
EAS	2	10 mm/s
	4, 6	25 mm/s
EAC	2	10 mm/s
	4, 6	25 mm/s
EZS	3, 4, 6	25 mm/s
EZSH	6	25 mm/s

- Unauthorized reproduction or copying of all or part of this Manual is prohibited.
If a new copy is required to replace an original manual that has been damaged or lost, please contact your nearest Oriental Motor sales office.
- Oriental Motor shall not be liable whatsoever for any problems relating to industrial property rights arising from use of any information, circuit, equipment or device provided or referenced in this manual.
- Characteristics, specifications and dimensions are subject to change without notice.
- While we make every effort to offer accurate information in the manual, we welcome your input. Should you find unclear descriptions, errors or omissions, please contact your nearest Oriental Motor sales office.
- **Orientalmotor** and ABZO sensor are registered trademarks or trademarks of Oriental Motor Co., Ltd., in Japan and other countries.

Other product names and company names mentioned in this manual may be registered trademarks or trademarks of their respective companies and are hereby acknowledged. The third-party products mentioned in this manual are recommended products, and references to their names shall not be construed as any form of performance guarantee. Oriental Motor is not liable whatsoever for the performance of these third-party products.

© Copyright ORIENTAL MOTOR CO., LTD. 2015

Published in May 2023

- Please contact your nearest Oriental Motor office for further information.

ORIENTAL MOTOR U.S.A. CORP.
Technical Support Tel:800-468-3982
8:30am EST to 5:00pm PST (M-F)
www.orientalmotor.com

ORIENTAL MOTOR (EUROPA) GmbH
Schiessstraße 44, 40549 Düsseldorf, Germany
Technical Support Tel:00 800/22 55 66 22
www.orientalmotor.de

ORIENTAL MOTOR (UK) LTD.
Unit 5 Faraday Office Park, Rankine Road,
Basingstoke, Hampshire RG24 8QB UK
Tel:+44-1256347090
www.oriental-motor.co.uk

ORIENTAL MOTOR (FRANCE) SARL
Tel:+33-1 47 86 97 50
www.orientalmotor.fr

ORIENTAL MOTOR ITALIA s.r.l.
Tel:+39-02-93906347
www.orientalmotor.it

ORIENTAL MOTOR ASIA PACIFIC PTE. LTD.
Singapore
Tel:1800-842-0280
www.orientalmotor.com.sg

ORIENTAL MOTOR (MALAYSIA) SDN. BHD.
Tel:1800-806-161
www.orientalmotor.com.my

ORIENTAL MOTOR (THAILAND) CO., LTD.
Tel:1800-888-881
www.orientalmotor.co.th

ORIENTAL MOTOR (INDIA) PVT. LTD.
Tel:1800-120-1995 (For English)
1800-121-4149 (For Hindi)
www.orientalmotor.co.in

TAIWAN ORIENTAL MOTOR CO., LTD.
Tel:0800-060708
www.orientalmotor.com.tw

SHANGHAI ORIENTAL MOTOR CO., LTD.
Tel:400-820-6516
www.orientalmotor.com.cn

INA ORIENTAL MOTOR CO., LTD.
Korea
Tel:080-777-2042
www.inaom.co.kr

ORIENTAL MOTOR CO., LTD.
4-8-1 Higashiueno, Taito-ku, Tokyo
110-8536 Japan
Tel:+81-3-6744-0361
www.orientalmotor.co.jp