

Rack and Pinion System

L Series

OPERATING MANUAL

Actuator Edition

Hardware edition

Function setting edition

Appendix

Thank you for purchasing an Oriental Motor product.

This Manual describes product handling procedures and safety precautions.

- Please read it thoroughly to ensure safe operation.
- Always keep the manual where it is readily available.

1 Hardware Edition

1	Introduction	6
1-1	Before use	6
1-2	Related operating manuals	6
1-3	Overview of the product	6
2	Safety precautions	7
3	Precautions for use	10
4	Preparation	13
4-1	Checking the product	13
4-2	How to identify the product model	13
4-3	Model list	14
4-4	Information about nameplate	15
4-5	Names of parts	15
5	Installation	16
5-1	Installation location	16
5-2	Installing the rack and pinion motor	16
5-3	Installing the load	18
5-4	Permissible radial load, permissible rotational torque (moment)	19
6	Connection	21
6-1	Connecting the driver	21
6-2	Protective Earth	21
7	Maintenance and inspection	23
7-1	Inspection	23
7-2	Warranty	23
7-3	Disposal	23
8	Regulations and standards	24
8-1	UL Standards	24
8-2	CE Marking/UKCA Marking	24
8-3	RoHS Directive	24
8-4	Machinery Directive	24
8-5	Equipped motor models that conform to standards	24
9	Specifications	25
9-1	Product specifications	25
9-2	General specifications	25
10	Accessories	26

2 Function Setting Edition

1	Setting of parameters.....	28
1-1	Guidance.....	28
1-2	Copying the fixed value of the ABZO sensor to a driver.....	29
1-3	Parameter list (initial value).....	32
1-4	Changing the moving direction of rack.....	40
1-5	Matching the resolution with the LAS Series.....	43
2	Operation.....	46
2-1	Absolute positioning operation.....	46
2-2	Return-to-home operation.....	52
2-3	Push-motion operation.....	54

3 Appendix

1	Dimensions.....	58
1-1	LM2 B type.....	58
1-2	LM2 F type.....	58
1-3	LM4 B type.....	59
1-4	LM4 F type.....	59

1 Hardware Edition

This part explains the product overview, safety precautions, names of each part, as well as installation and connection methods.

◆ Table of contents

1	Introduction	6	6	Connection	21
	1-1 Before use.....	6		6-1 Connecting the driver.....	21
	1-2 Related operating manuals.....	6		6-2 Protective Earth.....	21
	1-3 Overview of the product.....	6	7	Maintenance and inspection.....	23
2	Safety precautions	7		7-1 Inspection.....	23
3	Precautions for use.....	10		7-2 Warranty.....	23
4	Preparation	13		7-3 Disposal.....	23
	4-1 Checking the product.....	13	8	Regulations and standards.....	24
	4-2 How to identify the product model.....	13		8-1 UL Standards	24
	4-3 Model list	14		8-2 CE Marking/UKCA Marking.....	24
	4-4 Information about nameplate	15		8-3 RoHS Directive	24
	4-5 Names of parts.....	15		8-4 Machinery Directive.....	24
5	Installation	16		8-5 Equipped motor models that conform to standards.....	24
	5-1 Installation location	16	9	Specifications	25
	5-2 Installing the rack and pinion motor.....	16		9-1 Product specifications.....	25
	5-3 Installing the load.....	18		9-2 General specifications.....	25
	5-4 Permissible radial load, permissible rotational torque (moment).....	19	10	Accessories.....	26

1 Introduction

1-1 Before use

Only qualified personnel of electrical and mechanical engineering should work with the product. Use the product correctly after thoroughly reading the section "2 Safety precautions" on p.7. In addition, be sure to observe the contents described in warning, caution, and note in this manual. The product described in this manual is designed and manufactured to be incorporated in general industrial equipment. Do not use for any other purpose. Oriental Motor Co., Ltd. is not responsible for any compensation for damage caused through failure to observe this warning.

1-2 Related operating manuals

For operating manuals, download from Oriental Motor Website Download Page or contact your nearest Oriental Motor sales office.

- **L Series OPERATING MANUAL Actuator Edition** (this document)
- **AZ Series/Motorized actuator equipped with AZ Series OPERATING MANUAL Function Edition**

Refer to the operating manual of the driver for contents not described in these manuals.

1-3 Overview of the product

This product is described as "rack and pinion motor" in this manual.

- **A wide range of speed setting is possible**
The maximum speed of up to 500 mm/s can be set in the high-speed type.
- **Compact rack-and-pinion system**
This product contributes to downsizing and space-saving for equipment because of the structure combining a motor and a rack-and-pinion mechanism.
- **High-efficiency and energy-saving α STEP AZ Series motor is adopted**
The motor of the **AZ Series** is equipped with the mechanical multiple-rotation absolute sensor (ABZO sensor). The ABZO sensor can detect the absolute position for 1,800 revolutions (± 900 revolutions) of the motor output shaft. Therefore, the present position is held even if the power is cut off.
- **Rack and pinion motors with electromagnetic brake are also available in the product lineup.**
Rack and pinion motors with electromagnetic brake are useful for holding the position of a load when vertical drive such as elevating equipment is performed.





2 Safety precautions

The precautions described below are intended to ensure the safe and correct use of the product, and to prevent the customer and others from exposure to the risk of injury. Use the product only after carefully reading and fully understanding these instructions.

In regard to a rack and pinion motor, it is prohibited to start operating the rack and pinion motor (i.e., to operate the device in accordance with the specified purpose) when the machine in which the rack and pinion motor is incorporated does not satisfy any relevant safety standards. The factory safety manager or safety personnel in charge of the applicable machine must ensure that the machine is operated only by qualified personnel who are familiar with the operation of electronic equipment, and thereby prevent injury or damage to the equipment.



The term "qualified personnel" refers to persons who have received the necessary training or education and have pertinent experience; who are familiar with the relevant standards, regulations, accident-prevention rules and inspection conditions; who are authorized by the factory safety manager to engage in the necessary activities; and who have the ability to discern and prevent potential dangers.



Description of signs



 DANGER	The instructions, which accompany a "DANGER" symbol, indicate that mishandling the product may result in an imminent danger leading to immediate death or serious injury.
 WARNING	Handling the product without observing the instructions that accompany a "WARNING" symbol may result in serious injury or death.
 CAUTION	Handling the product without observing the instructions that accompany a "CAUTION" symbol may result in injury or property damage.
 Note	The items under this heading contain important handling instructions that the user should observe to ensure the safe use of the product.



Description of graphic symbols

	Indicates "prohibited" actions that must not be performed.		Indicates "compulsory" actions that must be performed.
---	--	---	--

 DANGER	
	<ul style="list-style-type: none"> Do not enter the moving range of the rack and pinion motor while the power is supplied. Be sure to provide a safety cage according to EN ISO 13857. If the rack and pinion motor moved to unexpected directions or ran at unexpected speeds during operation, serious injury may result. Operate the data setter outside the safety cage. Failure to do so may result in injury.

 WARNING	
	<ul style="list-style-type: none"> Do not use the product in explosive or corrosive environments, in the presence of flammable gases, in places subjected to splashing water, or near combustibles. Doing so may result in fire, electric shock or injury. Do not transport, install, connect or inspect the rack and pinion motor while the power is supplied. Doing so may result in electric shock. Do not forcibly bend, pull, or pinch the cable. Doing so may result in fire or electric shock. Do not disassemble or modify the rack and pinion motor. Doing so may result in injury or damage to equipment. Never use the rack and pinion motor in a medical device used in connection with the maintenance or management of human life or health, or in a transportation system whose purpose is to move or carry people. Do not use the brake mechanism of the electromagnetic brake motor for braking or as a safety brake. Doing so may result in injury or damage to equipment.

 WARNING	
	<ul style="list-style-type: none"> • Take measures to keep the moving part in position if the rack and pinion motor is used in vertical operations such as elevating equipment. Failure to provide such a measure may cause the moving parts to fall, resulting in injury or damage to equipment. • Assign qualified personnel to the task of installing, wiring, operating/controlling, inspecting and troubleshooting the product. Failure to do so may result in fire, electric shock, injury or damage to equipment. • When an alarm is generated in the driver (any of the driver's protective functions is triggered), take measures to hold the moving part in a specific position since the rack and pinion motor stops and loses its holding torque. Failure to do so may result in injury or damage to equipment. • Install the rack and pinion motor inside an enclosure. Failure to do so may result in electric shock or injury. • The rack and pinion motor of AC power input type is Class I equipment. When installing the rack and pinion motor, install it inside an enclosure so that it is out of the direct reach of users. Be sure to ground if users can touch it. Failure to do so may result in electric shock. • Provide an emergency stop device or emergency stop circuit external to the equipment so that the entire equipment will operate safely in the event of a system failure or malfunction. Failure to do so may result in injury. • When operating the rack and pinion motor, install a mechanical stopper or the like in order to prevent the rack from coming off. Failure to do so may result in injury or damage to equipment. • After replacing the driver, set the resolution, moving direction or other parameters before operating the rack and pinion motor. If the rack and pinion motor is operated without setting parameters, the rack may move to unexpected directions or run at unexpected speeds, causing injury or damage to equipment.

 CAUTION	
	<ul style="list-style-type: none"> • Do not use the rack and pinion motor beyond its specifications. Doing so may result in electric shock, injury, or damage to equipment. • Keep your fingers and objects out of the openings in the rack and pinion motor. Failure to do so may result in fire, electric shock or injury. • Do not touch the rack and pinion motor during operation or immediately after stopping. The surface is hot, and this may cause a skin burn(s). • Do not carry the rack and pinion motor by holding the moving part or cable. Doing so may result in injury. • Keep the rack in a horizontal direction when transporting the rack and pinion motor. Transporting in a state where the rack is made in a vertical direction may cause it to fall out, leading to injury. • Do not place combustibles around the rack and pinion motor. Doing so may result in fire or a skin burn(s). • Do not leave anything around the rack and pinion motor that would obstruct ventilation. Doing so may result in damage to equipment. • Do not touch the moving part during operation. Doing so may result in injury. • Do not touch the terminals while conducting the insulation resistance measurement or dielectric strength test. Doing so may cause electric shock. • Do not use our photomicrosensor set as safety-related parts. Doing so may result in injury or damage to equipment.

⚠ CAUTION

- Use a rack and pinion motor and driver only in the specified combination. An incorrect combination may cause a fire.
- The rack and pinion motor is very heavy. When transporting or installing the rack and pinion motor, make sure two persons work together to carry out the necessary tasks. Failure to do so may result in lower back pain or injury.
- Wear a helmet, safety shoes, gloves or other protective gear when transporting or installing the rack and pinion motor. Failure to do so may result in injury.
- Provide a cover over the rack of the rack and pinion motor. Failure to do so may result in injury.
- Wear safety goggles during operation because grease applied to the rack may scatter. If grease gets into the eyes or comes in contact with the skin, immediately flush the area thoroughly with water.
- The rack and pinion motor surface temperature may exceed 70 °C (158 °F) even under normal operating conditions. If the operator is allowed to approach the rack and pinion motor in operation, affix a warning label shown in the figure on a conspicuous position. Failure to do so may result in skin burn(s).



Warning label

3 Precautions for use

This chapter covers restrictions and requirements the user should consider when using the product.

■ General

- **When conducting the insulation resistance measurement or the dielectric strength test, be sure to separate the connection between the rack and pinion motor and the driver.**

Conducting the insulation resistance measurement or dielectric strength test with the rack and pinion motor and driver connected may result in damage to the product.

- **Do not apply a radial load and rotational torque (moment) in excess of the specified permissible limit.**

Continuing to operate the rack and pinion motor under an excessive radial load or rotational torque (moment) may cause the rack bushings to abrade away in a short time or to damage. Do not apply the radial load and rotational torque (moment) in excess of the specified permissible values.

Even if the radial load and rotational torque (moment) are at the permissible values or below, repeated operations of the rack and pinion motor will still cause the rack bushings to abrade. To suppress abrasion of the rack bushings, install a guide or the like to reduce the radial load and rotational torque (moment).

Refer to p.19 for details about radial load and rotational torque (moment).

- **Rack stroke**

The rack stroke represents a length from the rack end to the rack bushing (per one side).

When operating the rack and pinion motor, be sure to reverse the moving direction of the rack before one end of the rack enters in the rack bushing. Proper operation can be performed when the rack is supported by the rack bushings located on both ends of the rack case.

If it is difficult to check the rack bushing on the mounting foot side when the F type is installed on equipment, it is recommended to use the rack with an enough margin in stroke to prevent the rack from entering in the rack bushing.

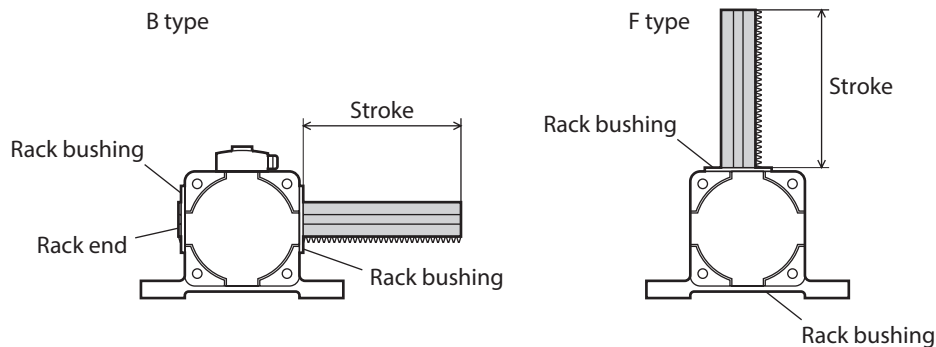

- **Installing the sensor**

When using our photomicrosensor, install it before securing a load. If a load is secured to the rack first, the sensor bracket cannot be installed.

- **Grease**

- The rack case is filled with grease at the time of shipment. Do not wipe off grease on the surface or the tooth surface of the rack. Wiping off the grease reduces the lubrication between the tooth surfaces, leading to a shorter life of the rack and pinion. Always operate the rack and pinion motor in a state where grease is applied on the surface and tooth surfaces of the rack properly.
- On rare occasions, a small amount of grease may ooze out from the rack and pinion motor. If there is concern over possible environmental damage resulting from the leakage of grease, check for grease stains during regular inspections. Alternatively, install an oil pan or other device to prevent leakage from causing further damage. Oil leakage may lead to problems in the customer's equipment or products.

- **Be sure to use our cable to connect the rack and pinion motor and the driver.**

Check on the Oriental Motor Website for the model name.

- **Do not make a strong impact on the rack and pinion motor.**

Do not make the rack and pinion motor fall. Also, do not hit or strike the rack and pinion motor. Making an impact on the rack and pinion motor may cause the positioning accuracy to decrease, the rack and pinion motor to damage, or the lifetime to reduce.

- **Make sure not to hit or apply a strong impact on the encoder (ABZO sensor).**

Making a strong impact on an encoder (ABZO sensor) may cause the rack and pinion motor malfunction or damage to the encoder (ABZO sensor). When transporting the rack and pinion motor or installing a load, handle the rack and pinion motor carefully not to make a strong impact on the moving part. The warning label shown in the figure is attached on the rack and pinion motor.

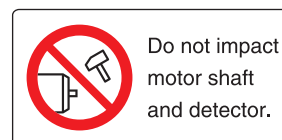

Warning label

- **Do not move the encoder (ABZO sensor) toward a strong magnetic field.**

A magnetic sensor is built into the encoder (ABZO sensor). If the rack and pinion motor is installed close to equipment which generates a strong magnetic field, the encoder (ABZO sensor) may break or malfunction. Keep the magnetic flux density on the surface of the encoder (ABZO sensor) so as not to exceed the values in the table.

	Magnetic flux density
When operating	10 mT
When transporting and storing	10 mT

- **Meshing noise of mechanical sensor**

A gear type mechanical sensor is built into the encoder (ABZO sensor). Although the meshing noise of gears may generate, it is not malfunction.

■ Operation

- **Operate the rack and pinion motor at the maximum transportable mass or below.**

Operating the rack and pinion motor with a load exceeding the maximum transportable mass may cause damage to the rack tooth surface or pinion. Be sure to operate it with a load at the maximum transportable mass or below. Check on the Oriental Motor Website for the maximum transportable mass.

- **Perform push-motion operation within the specifications.**

When push-motion operation is performed, set the speed and push force within the specification values. Operating push-motion operation outside the specification range may cause damage to the rack tooth surface, pinion, or gear part.

- **Positioning direction**

When positioning operation is performed, stopping from only one direction can improve the stopping accuracy to suppress the influence of backlash.

- **Use a rack and pinion motor with electromagnetic brake in an application of vertical drive such as elevating equipment.**

To hold a load or the rack position, use a rack and pinion motor with electromagnetic brake in an application of vertical drive such as elevating equipment.

- **Do not use the electromagnetic brake for braking or as a safety brake.**

- Since the power off activated type electromagnetic brake is equipped, it helps maintain the position of the load when the power is cut off, but this brake cannot securely hold the load in place. Accordingly, do not use the electromagnetic brake as a safety brake.
- Do not use the electromagnetic brake as a means to decelerate and stop the rack and pinion motor. The brake hub of the electromagnetic brake will wear significantly and the braking force will drop.
- To use the electromagnetic brake to hold the load in place, do so after the rack and pinion motor has stopped.

■ Temperature

- **Use the rack and pinion motor in conditions where the motor surface temperature does not exceed 80 °C (176 °F).**

The motor surface temperature may exceed 80 °C (176 °F) under certain conditions (ambient temperature, operating speed, duty cycle, etc.). In order to protect the encoder (ABZO sensor), use the motor in conditions where the surface temperature does not exceed 80 °C (176 °F). If the encoder (ABZO sensor) temperature reaches the upper limit, the motor overheat protection alarm will generate.

■ Notes when the connection cable is used

Note the following points when our cable is used.

● When inserting the connector

Hold the connector main body, and insert it in straight securely. Inserting the connector in an inclined state may result in damage to terminals or a connection failure.

● When pulling out the connector

Pull out the connector in straight while releasing the lock part of the connector. Pulling out the connector with holding the cable may result in damage to the connector.

● Bending radius of cable

Use the cable in a state where the bending radius of the cable is more than six times of the cable diameter. Do not bend the lead wires part or fix it with a clamp. Doing so may cause damage to the connector.

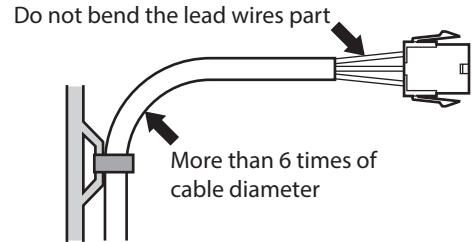

● How to fix the cable

Fix the cable near the connectors at two places as shown in the figure or fix it with a wide clamp to take measures to prevent stress from being applied to the connectors.

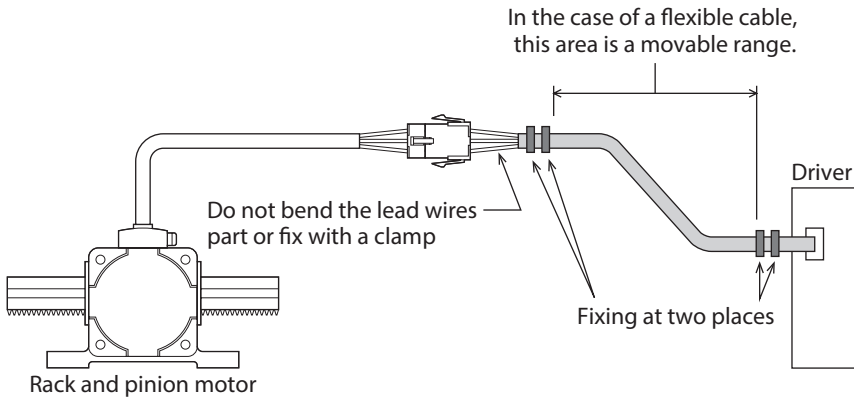

4 Preparation

This chapter explains the items you should check, as well as the name of each part.

4-1 Checking the product

Verify that the items listed below are included. Report any missing or damaged items to the Oriental Motor sales office from which you purchased the product.

- Rack and pinion motor 1 unit
- Instructions and Precautions for Safe Use 1 copy
- APPENDIX UL Standards for **AZ** Series 1 copy

4-2 How to identify the product model

Check the model name of the rack and pinion motor against the number shown on the nameplate.

LM 4 F 500 AZ M C - 10
 1 2 3 4 5 6 7 8

1	Series name	LM: L Series
2	Frame size of rack case front face	2: 60 mm (2.36 in.) 4: 80 mm (3.15 in.)
3	Rack moving direction	B: Horizontal to mounting foot surface F: Vertical to mounting foot surface
4	Rack maximum speed	<ul style="list-style-type: none"> • AC power input type <ul style="list-style-type: none"> 40: 40 mm/s (Large transportable mass type) 90: 90 mm/s (Large transportable mass type) 500: 500 mm/s (High-speed type) • DC power input type <ul style="list-style-type: none"> 20: 20 mm/s (Large transportable mass type) 50: 50 mm/s (Large transportable mass type) 150: 150 mm/s (High-speed type) 200: 200 mm/s (High-speed type)
5	Equipped motor	AZ: AZ Series
6	Motor type	A: Standard M: With electromagnetic brake
7	Power supply input	C: AC power input type K: DC power input type
8	Rack stroke	1: 100 mm (3.94 in.) 2: 200 mm (7.87 in.) 3: 300 mm (11.81 in.) 4: 400 mm (15.75 in.) 5: 500 mm (19.69 in.) 6: 600 mm (23.62 in.) 7: 700 mm (27.56 in.) 8: 800 mm (31.50 in.) 9: 900 mm (35.43 in.) 10: 1,000 mm (39.37 in.)

4-3 Model list

- The box (●) in the model name indicates **B** (horizontal to mounting foot surface) or **F** (vertical to mounting foot surface) representing the rack moving direction.
- The box (■) in the model name indicates **A** (standard) or **M** (with electromagnetic brake) representing the motor type.

■ AC power input type

High-speed type

Rack maximum speed	Rack and pinion motor model
500 mm/s	LM2●500AZ■C-1
	LM2●500AZ■C-2
	LM2●500AZ■C-3
	LM2●500AZ■C-4
	LM2●500AZ■C-5
	LM2●500AZ■C-6
	LM2●500AZ■C-7
	LM2●500AZ■C-8
	LM4●500AZ■C-1
	LM4●500AZ■C-2
	LM4●500AZ■C-3
	LM4●500AZ■C-4
	LM4●500AZ■C-5
	LM4●500AZ■C-6
	LM4●500AZ■C-7
	LM4●500AZ■C-8
	LM4●500AZ■C-9
	LM4●500AZ■C-10

Large transportable mass type

Rack maximum speed	Rack and pinion motor model
90 mm/s	LM2●90AZ■C-1
	LM2●90AZ■C-2
	LM2●90AZ■C-3
	LM2●90AZ■C-4
	LM2●90AZ■C-5
	LM2●90AZ■C-6
	LM2●90AZ■C-7
	LM2●90AZ■C-8
40 mm/s	LM4●40AZ■C-1
	LM4●40AZ■C-2
	LM4●40AZ■C-3
	LM4●40AZ■C-4
	LM4●40AZ■C-5
	LM4●40AZ■C-6
	LM4●40AZ■C-7
	LM4●40AZ■C-8
	LM4●40AZ■C-9
	LM4●40AZ■C-10

■ DC power input type

High-speed type

Rack maximum speed	Rack and pinion motor model
200 mm/s	LM2●200AZ■K-1
	LM2●200AZ■K-2
	LM2●200AZ■K-3
	LM2●200AZ■K-4
	LM2●200AZ■K-5
150 mm/s	LM4●150AZ■K-1
	LM4●150AZ■K-2
	LM4●150AZ■K-3
	LM4●150AZ■K-4
	LM4●150AZ■K-5
	LM4●150AZ■K-6
	LM4●150AZ■K-10

Large transportable mass type

Rack maximum speed	Rack and pinion motor model
50 mm/s	LM2●50AZ■K-1
	LM2●50AZ■K-2
	LM2●50AZ■K-3
	LM2●50AZ■K-4
	LM2●50AZ■K-5
20 mm/s	LM4●20AZ■K-1
	LM4●20AZ■K-2
	LM4●20AZ■K-3
	LM4●20AZ■K-4
	LM4●20AZ■K-5
	LM4●20AZ■K-6
	LM4●20AZ■K-10

4-4 Information about nameplate

The figure shows an example.

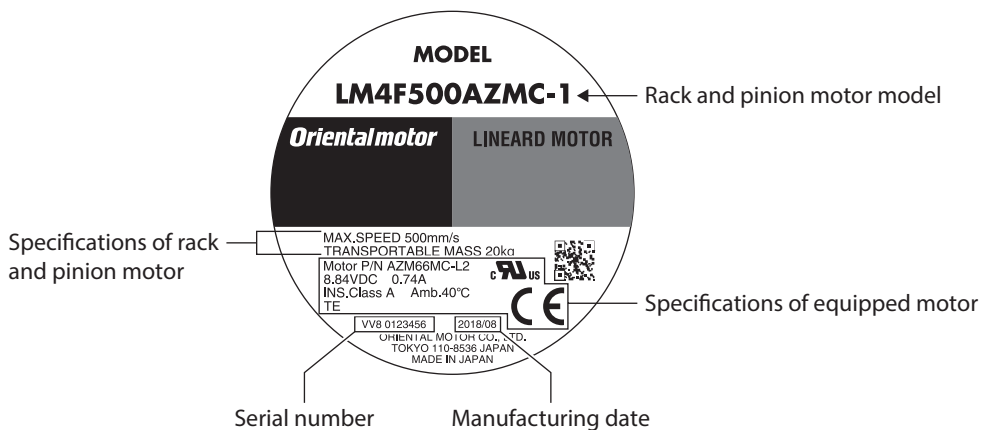

memo The position describing the information may vary depending on the product.

4-5 Names of parts

The figure shows the **LM2B500AZMC-1**.

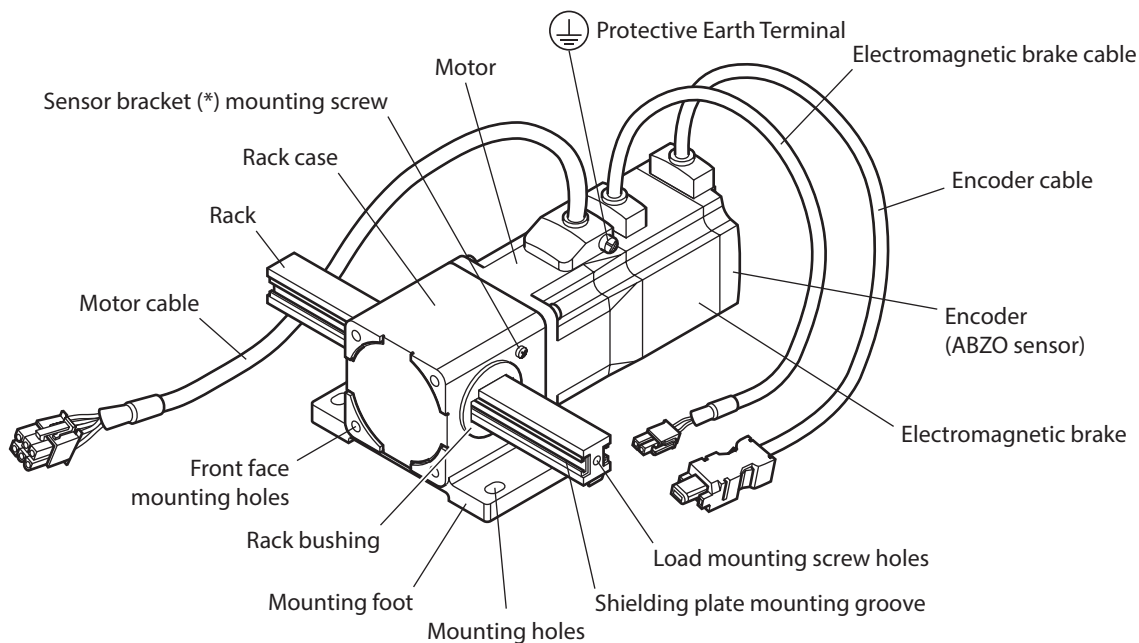

* It is a bracket to install our photomicrosensor set.

5 Installation

5-1 Installation location

The rack and pinion motor is designed and manufactured to be incorporated in equipment. Install it in a well-ventilated location that provides easy access for inspection. The location must also satisfy the following conditions:

- Inside an enclosure that is installed indoors (provide vent holes)
- Operating ambient temperature: 0 to +40 °C (+32 to +104 °F) (non-freezing)
- Operating ambient humidity: 85% or less (non-condensing)
- Area free of explosive atmosphere or toxic gas (such as sulfuric gas) or liquid
- Area not exposed to direct sun
- Area free of excessive amount of dust, iron particles or the like
- Area not subject to splashing water (rain, water droplets), oil (oil droplets) or other liquids
- Area free of excessive salt
- Area not subject to continuous vibrations or excessive shocks
- Area free of excessive electromagnetic noise (from welders, power machinery, etc.)
- Area free of radioactive materials, magnetic fields or vacuum
- Up to 1,000 m (3,300 ft.) above sea level

■ If a rack and pinion motor is installed in an environment where a magnetic field is generated

A magnetic sensor is built into the encoder (ABZO sensor). If the rack and pinion motor is installed close to equipment which generates a strong magnetic field, the encoder (ABZO sensor) may break or malfunction. Make sure to prevent the magnetic flux density on the surface of the encoder (ABZO sensor) from exceeding 10 mT.

Note Do not install the rack and pinion motor close to equipment which generates a strong magnetic field.

5-2 Installing the rack and pinion motor

Install the rack and pinion motor using the mounting foot or the mounting holes provided on the front face.

Note When a rack and pinion motor without electromagnetic brake is installed, the rack may fall out or a load may drop if the rack is made in a vertical direction. Place a cushioning material or the like under the rack and pinion motor to prevent injury or damage caused by fallen objects.

■ Mounting plate

The thickness of the mounting plate indicated in the table is the minimum requirements for installation. If high accuracy is required, design the thickness of the mounting plate in consideration of the installation conditions such as load condition, rigidity, vibration and others.

Material	Aluminum
Thickness	10 mm (0.39 in.) or more

■ Installation using mounting foot

1. Drill mounting holes or mounting screw holes in the mounting plate. [unit: mm (in.)]
Also, drill a hole (G) through which the rack is passed for the F type.

B type

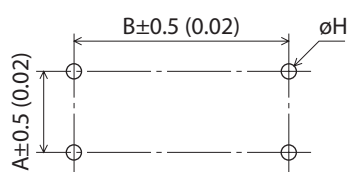

F type

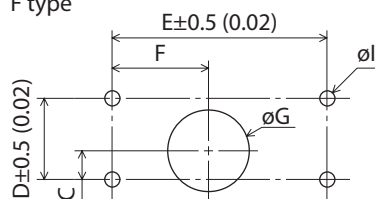

Model	B type			F type					
	A	B	øH	C	D	E	F	øG	øI
LM2	35 (1.38)	92 (3.62)	6.5 (0.26)	12.5 (0.49)	35 (1.38)	92 (3.62)	41 (1.61)	35 (1.38)	6.5 (0.26)
LM4	30 (1.18)	100 (3.94)	8.5 (0.33)	15 (0.59)	30 (1.18)	100 (3.94)	41.65 (1.64)	45 (1.77)	8.5 (0.33)

2. Secure with four screws (not included) so that there is no gap between the rack and pinion motor and mounting plate. Values of the tightening torque are recommended. Tighten the screws with a suitable torque according to the design conditions of the mounting plate.

B type

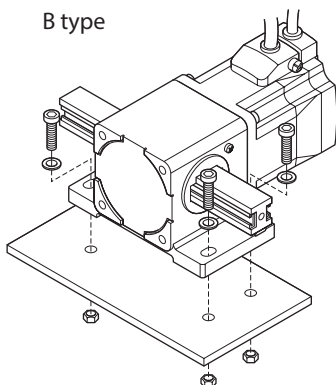

F type

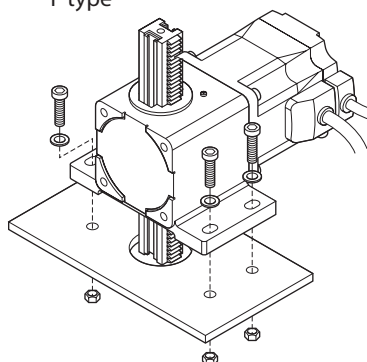

Model	Thickness of mounting foot [mm (in.)]	Nominal size	Tightening torque [N·m (lb-in)]
LM2	9 (0.35)	M6	9 (79)
LM4	12 (0.47)	M8	15 (132)

■ Installation using mounting holes on the front face

1. Drill mounting holes or mounting screw holes in the mounting plate. [unit: mm (in.)]
The machining dimensions of the mounting holes are common to the B type and F type.

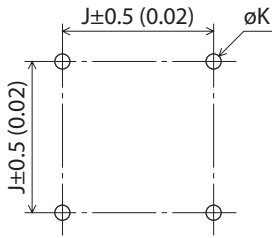

Model	J	øK
LM2	47 (1.85)	6.5 (0.26)
LM4	62 (2.44)	8.5 (0.33)

2. Secure with four screws (not included) so that there is no gap between the rack and pinion motor and mounting plate. Values of the tightening torque are recommended. Tighten the screws with a suitable torque according to the design conditions of the mounting plate.

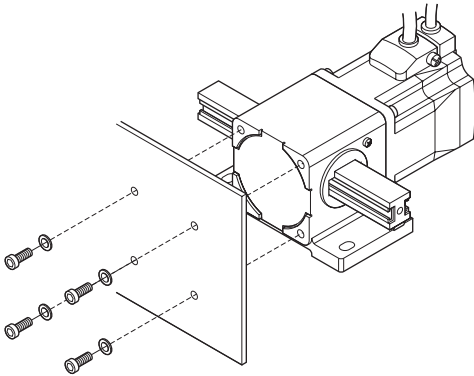

Model	Effective depth of screw thread [mm (in.)]	Nominal size	Tightening torque [N·m (lb-in)]
LM2	10 (0.39)	M6	5 (44)
LM4	10 (0.39)	M8	12 (106)

Note Be sure to tighten with the specified torque. Tightening with the specified torque or higher may cause the rack and pinion motor to damage.

5-3 Installing the load

Secure a load with a screw (not included) to the load mounting screw hole on the end face of the rack.
When installing a load, be sure to secure the rack with a wrench so that a rotational force does not applied to the rack.
Values of the tightening torque are recommended. Tighten the screws with a suitable torque according to the design conditions of the load.

Model	Effective depth of screw thread [mm (in.)]	Nominal size	Tightening torque [N·m (lb-in)]	Dimension A [mm (in.)]
LM2	10 (0.39)	M5	5 (44)	16 (0.63)
LM4	15 (0.59)	M8	15 (132)	20 (0.79)

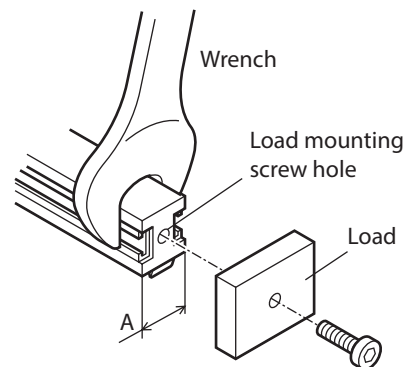

- Note**
- When connecting a load, align the shaft center line of the rack with that of the load. Failure to do so may cause damage to the rack.
 - When using our photomicrosensor, install it before securing a load. If a load is secured to the rack first, the sensor bracket cannot be installed.

5-4 Permissible radial load, permissible rotational torque (moment)

Note Do not apply the radial load and rotational torque (moment) in excess of the specified permissible values. If the operation is continued in a state where the radial load or rotational torque (moment) in excess of the permissible values is applied, the rack bushings may abrade away in a short time, causing the positioning accuracy to decrease or the rack or rack case to damage.

memo Even if the radial load and the rotational torque (moment) are equal to or lower than the permissible values, it is recommended to provide a guide to reduce or disperse the load.

■ Permissible radial load

The radial load on the rack end must be kept the permissible values listed in the table.

*1 The box (●) in the model name indicates **B** (horizontal to mounting foot surface) or **F** (vertical to mounting foot surface) representing the rack moving direction.

*2 The value is the operating speed of up to 90 mm/s. When operating at the speed exceeding 90 mm/s, provide a guide or the like so that the radial load does not applied to the rack.

*3 Provide a guide or the like so that the radial load does not applied because the rack is damaged.

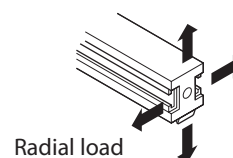

AC power input type

Stroke [mm (in.)]	Permissible radial load [N (lb.)]			
	LM2●90 *1	LM2●500 *1	LM4●40 *1	LM4●500 *1
100 (3.94)	25 (5.6)	25 (5.6) *2	120 (27)	60 (13.5) *2
200 (7.87)	20 (4.5)	20 (4.5) *2	90 (20)	40 (9) *2
300 (11.81)	10 (2.2)	10 (2.2) *2	70 (15.7)	30 (6.7) *2
400 (15.75)	10 (2.2)	10 (2.2) *2	60 (13.5)	25 (5.6) *2
500 (19.69)	7 (1.57)	7 (1.57) *2	50 (11.2)	20 (4.5) *2
600 (23.62)	*3	*3	40 (9)	15 (3.3) *2
700 (27.56)	*3	*3	40 (9)	10 (2.2) *2
800 (31.50)	*3	*3	25 (5.6)	7 (1.57) *2
900 (35.43)	–	–	20 (4.5)	*3
1,000 (39.37)	–	–	15 (3.3)	*3

DC power input type

Stroke [mm (in.)]	Permissible radial load [N (lb.)]			
	LM2●50 *1	LM2●200 *1	LM4●20 *1	LM4●150 *1
100 (3.94)	25 (5.6)	25 (5.6) *2	120 (27)	60 (13.5) *2
200 (7.87)	20 (4.5)	20 (4.5) *2	90 (20)	40 (9) *2
300 (11.81)	10 (2.2)	10 (2.2) *2	70 (15.7)	30 (6.7) *2
400 (15.75)	10 (2.2)	10 (2.2) *2	60 (13.5)	25 (5.6) *2
500 (19.69)	7 (1.57)	7 (1.57) *2	50 (11.2)	20 (4.5) *2
600 (23.62)	–	–	40 (9)	15 (3.3) *2
1,000 (39.37)	–	–	15 (3.3)	*3

■ **Permissible rotational torque (moment)**

The rotational torque (moment) on the rack end must be kept the permissible values listed in the table.

Model	Permissible rotational torque (moment)
LM2	0.3 N·m (2.6 lb-in) or less
LM4	0.5 N·m (4.4 lb-in) or less



■ **Gap between rack and rack bushing**

The rack and pinion motor has a slight gap between the rack and the rack bushing. Initial values of the backlash generated from the gap are as follows.

Backlash generated from gap

- A, B directions: About 2 mm (0.08 in.) *
- C directions: About 0.5 mm (0.02 in.)
- D direction: About 0.5°

* The values are measured at 500 mm (19.69 in.) from the end face of the rack case.

Operating the rack and pinion motor repeatedly will cause the rack bushings to abrade, causing the backlash to increase. If there is concern about the backlash, provide a guide or the like.

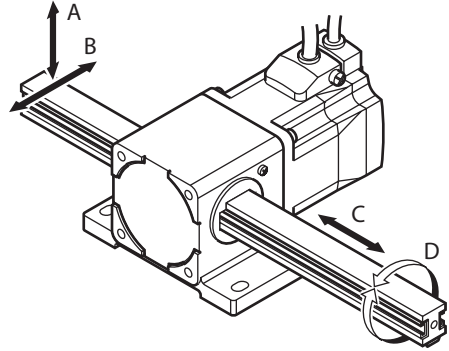

6 Connection

6-1 Connecting the driver

Refer to the operating manual of the driver for how to connect the driver.

6-2 Protective Earth

- memo**
- When multiple actuators of AC power input type are used in combination, provide protective earth for each actuator.
 - Do not share the grounding wire with a welder or power equipment.

Protective earth is not required for DC power input type actuators. AC power input type actuators can be grounded by connecting the protective earth wire of the cable for motor to the Protective Earth Terminal of the driver. However, if grounding the protective earth wire of the cable for motor does not satisfy the grounding resistance required by the applicable standard of the equipment, the Protective Earth Terminal of the motor must also be grounded.

1) Grounding the protective earth wire of the rack and pinion motor

Connect the protective earth wire of the cable for motor to the Protective Earth Terminal of the driver.

Cable type	Connection cable	Flexible connection cable
Conductor wire size	AWG18 (0.75 mm ²)	AWG18 (0.75 mm ²)
Maximum conductor resistance	21.8 Ω/km	25.6 Ω/km
Tightening torque	1.2 N·m (170 oz-in)	

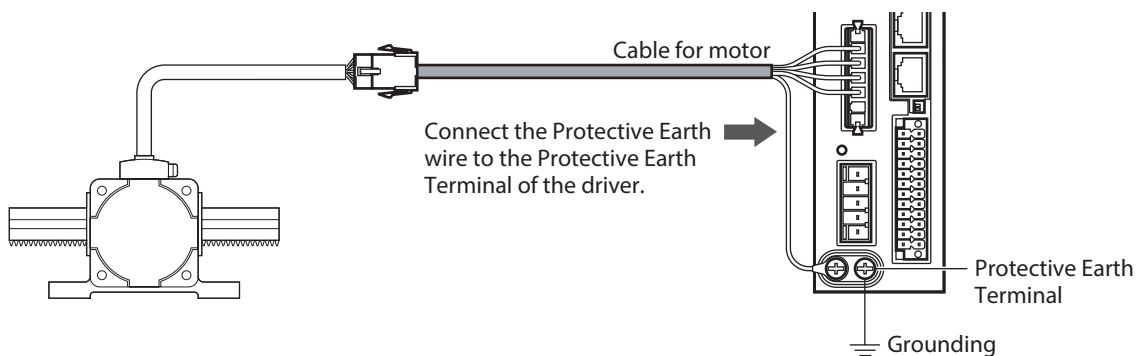

- memo**
- Ground the Protective Earth Terminal of the rack and pinion motor if the grounding resistance required by the applicable standard of the equipment is not satisfied.

2) Grounding the Protective Earth Terminal of the rack and pinion motor

Ground the Protective Earth Terminal of the rack and pinion motor. Use a round terminal when grounding, and make sure to secure with a screw and washer.

A grounding wire and a crimp terminal are not included.

- Grounding wire: AWG 18 (0.75 mm²) or thicker
- Screw size of Protective Earth Terminal: M4
- Tightening torque: 1.2 N·m (170 oz-in)

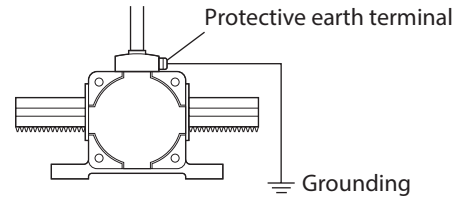

7 Maintenance and inspection

7-1 Inspection

It is recommended that periodic inspections would be conducted for the items listed below after each operation of the rack and pinion motor. If an abnormal condition is noted, discontinue any use and contact your nearest Oriental Motor sales office.

■ Inspection item

- Check if any of the screws having installed the rack and pinion motor is loose.
- Check if the bearing part (ball bearings) of the rack and pinion motor or the meshing part with the rack generates unusual noises.
- Check if a damage or stress is applied on the cable.
- Check if the connection part with the driver is loose.
- Check if the grease on the rack is insufficient.
- Check if the gap between the rack and rack bushing is increased.
- Check if any of the screw installing a load is loose.

7-2 Warranty

Check on the Oriental Motor Website for the product warranty.

7-3 Disposal

Dispose the product correctly in accordance with laws and regulations, or instructions of local governments.

8 Regulations and standards

8-1 UL Standards, CSA Standards

Check the "APPENDIX UL Standards for **AZ Series**" for recognition information about UL Standards of the equipped motor.

8-2 CE Marking/UKCA Marking

- **EU Low Voltage Directive/UK Electrical Equipment (Safety) Regulation**

Equipped motors of AC power input type are affixed the marks under the following directives/regulations.

- **EU EMC Directive/UK EMC Regulation**

The driver combining with the rack and pinion motor is affixed the marks under the EMC. For details about applicable standards and others, check with the operating manual of the driver.

8-3 EU RoHS Directive/UK RoHS Regulation

This product does not contain the substances exceeding the restriction values.

8-4 Machinery Directive

The rack and pinion motor and driver are designed and manufactured to be incorporated in general industrial equipment, and a Declaration of Incorporation of Partly Completed Machinery is issued with them according to the Machinery Directive.

Applicable standards: EN ISO 12100, EN 60204-1

8-5 Equipped motor models that conform to standards

Model names of the equipped motor that conform to the standards are listed below. Check with the nameplate of the product used. The motor model is described as "Motor P/N" on the nameplate.

- The box (●) in the model name indicates **B** (horizontal to mounting foot surface) or **F** (vertical to mounting foot surface) representing the rack moving direction.
- The box (■) in the model name indicates **A** (standard) or **M** (with electromagnetic brake) representing the motor type.
- The box (◆) in the model name indicates a number representing the rack stroke.

AC power input type

Rack and pinion motor model	Equipped motor model (Motor P/N)
LM2●500AZ■C-◆	AZM66■C-L1
LM2●90AZ■C-◆	AZM66■C-L1
LM4●500AZ■C-◆	AZM66■C-L2
LM4●40AZ■C-◆	AZM66■C-TS

DC power input type

Rack and pinion motor model	Equipped motor model (Motor P/N)
LM2●200AZ■K-◆	AZM66■K-L1
LM2●50AZ■K-◆	AZM66■K-L1
LM4●150AZ■K-◆	AZM66■K-L2
LM4●20AZ■K-◆	AZM66■K-TS

9 Specifications

9-1 Product specifications

Check on the Oriental Motor Website for the product specifications.

9-2 General specifications

■ Installation conditions

The product described in this manual is designed and manufactured to be incorporated in general industrial equipment.

Input power supply	AC power supply	DC power supply
Overvoltage category	II	I
Protection against electric shock	Class I	Class III
Pollution degree	2	
Degree of protection	IP30 (Excluding the rack moving part and connectors.)	
Noise level	70 dB or less	

■ Environmental conditions

	Operation environment	Storage, shipping environment
Ambient temperature	0 to +40 °C (+32 to +104 °F) (non-freezing)	–20 to +60 °C (–4 to +140 °F) (non-freezing)
Ambient humidity	85% or less (non-condensing)	
Altitude	Up to 1,000 m (3,300 ft.) above sea level	Up to 3,000 m (10,000 ft.) above sea level

10 Accessories

■ Photomicrosensor sets

Model	Applicable product	Sensor output
PARP-PS2B	LM2	NPN
PARP-PS4B	LM4	

■ Rack covers (for photomicrosensor set)

Model	Applicable product	Applicable stroke [mm (in.)]
2LSC-P02	LM2	100 (3.94), 200 (7.87)
2LSC-P04		300 (11.81), 400 (15.75)
4LSC-P02	LM4	100 (3.94), 200 (7.87)
4LSC-P04		300 (11.81), 400 (15.75)

■ Regeneration resistor

Model: **RGB100**



The regeneration resistor cannot be used with the DC input driver drivers.

2 Function Setting Edition

This part explains settings of parameters required when the driver is combined with rack and pinion motor.

◆ Table of contents

1	Setting of parameters.....	28
1-1	Guidance.....	28
1-2	Copying the fixed value of the ABZO sensor to a driver	29
1-3	Parameter list (initial value).....	32
1-4	Changing the moving direction of rack.....	40
1-5	Matching the resolution with the LAS Series	43
2	Operation	46
2-1	Absolute positioning operation	46
2-2	Return-to-home operation	52
2-3	Push-motion operation	54

1 Setting of parameters

1-1 Guidance

Use the product described in this manual together with the **MEXE02** with software version 3.55 or later and the driver with software version 4.30 or later. Note that some functions cannot be used if the software version of the **MEXE02** or driver is early.

- Using the **MEXE02** with software version 3.55 or later can update the version of the driver.
- The version of the driver can be checked using the unit information monitor window of the **MEXE02**. Refer to the **AZ Series OPERATING MANUAL Function Edition** for details.

STEP1 Install the rack and pinion motor.



STEP2 Connect to the driver.



STEP3 Start the support software **MEXE02**.

Parameters such as the moving direction and minimum travel amount have been set in the ABZO sensor at the time of shipment. (fixed value)



STEP4 Copy the fixed value of the ABZO sensor to the driver. (⇒p.29)

Be sure to copy the ABZO information when changing a parameter from the initial value.



STEP5 Set the software limit when no sensor is used.



STEP6 Check the movement of the rack and pinion motor.



STEP7 Save the set data.

⚠ CAUTION

For some parameters, the unit of travel amount may change from "mm" to "step" if the parameter is changed from the initial value. Note that the unit of travel amount cannot return to "mm" if it changed to "step."

Note

- When the rack and pinion motor is used in combination with the pulse input type driver, do not change the SW1-No.1 of the function setting switch on the driver (factory setting: OFF). If this switch is set to ON, the resolution is fixed to 10,000 P/R, and an unexpected movement may result.
- If the rack is operated in a vertical direction, an alarm of overvoltage may be detected depending on the driving condition. If an alarm of overvoltage is detected, reconsider the operating condition or use our regeneration resistor **RGB100** when the AC power input products are used.
- If the driver is required to restore to the factory setting, select "Restored to the factory setting" under the "Communication" menu to initialize.
- After restoring to the factory setting, copy the ABZO information (fixed value) to the driver again.

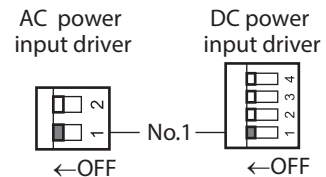

■ Unit of travel amount and electronic gear (minimum travel amount)

The electronic gear is set in the rack and pinion motor at the time of shipment. It helps to convert to “mm” easily even if the unit of travel amount changes to “step.” Note that the minimum travel amount is also changed if the electronic gear is changed.

Initial value of “Electronic gear” parameters (AC power input type)

Model *	Electronic gear A	Electronic gear B	Travel amount per step (minimum travel amount)
LM2●500	49,940	49,927	0.01 mm
LM2●90	30,774	57,492	0.001 mm
LM4●500	64,610	64,667	0.01 mm
LM4●40	62,416	46,298	0.001 mm

* The box (●) in the model name indicates **B** (horizontal to mounting foot surface) or **F** (vertical to mounting foot surface) representing the rack moving direction.

1-2 Copying the fixed value of the ABZO sensor to a driver

In a state of the factory shipment, the parameter information (fixed value) stored in the ABZO sensor is used preferentially. However, if a parameter is changed with the **MEXE02**, all parameters including the changed parameter will be changed to the values set in the driver. Therefore, an unexpected movement may cause when an operation is executed. In order to prevent such problems, copy the ABZO information (fixed value) to the driver, and match the data in the driver parameter with the fixed value in the ABZO sensor. After copying to the driver, read the fixed value from the driver to the **MEXE02**.



Note In the case of having changed a parameter from the initial value, note that the parameter will not return to the fixed value even if the ABZO information (fixed value) is copied after writing from the **MEXE02** to the driver.

● Example: When changing the mechanism settings parameter of LM4●40

ABZO information (fixed value): Not copied

	Active	Driver parameter
Mechanism settings	ABZO	Prioritize ABZO setting
Electronic gear A	62416	1
Electronic gear B	46298	1



When the mechanism settings parameter is changed



	Active	Driver parameter
Mechanism settings	Driver parameter	Manual setting
Electronic gear A	1	1
Electronic gear B	1	1

Values of the electronic gear (applied) will be changed.

ABZO information (fixed value): Copied

	Active	Driver parameter
Mechanism settings	ABZO	Prioritize ABZO setting
Electronic gear A	62416	62416
Electronic gear B	46298	46298



When the mechanism settings parameter is changed



	Active	Driver parameter
Mechanism settings	Driver parameter	Manual setting
Electronic gear A	62416	62416
Electronic gear B	46298	46298

Values of the electronic gear (applied) will not be changed.

■ **Procedure**

1. Click "Copy the ABZO (fixed) information to the driver in a lump" under the "Communication" menu.

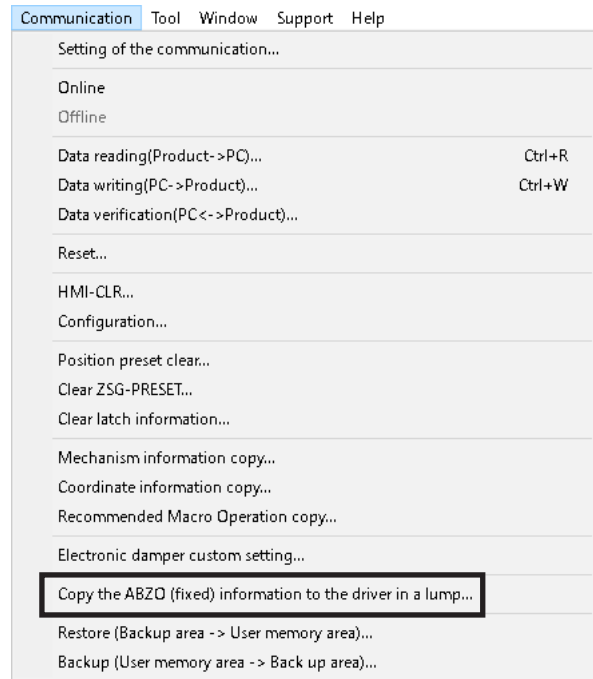

2. Click [Yes].
The ABZO information (fixed value) is copied in the driver.

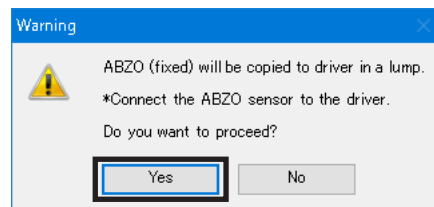

3. After it is completed, click [OK].

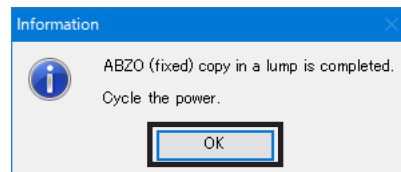

4. Turn on the control power supply again.
The parameter information is updated to the driver.
5. Read the ABZO information (fixed value) copied to the driver to the **MEXE02** in the following steps.

- 1) Click "Data reading" under the "Communication" menu or click the [Data reading] icon in the toolbar.

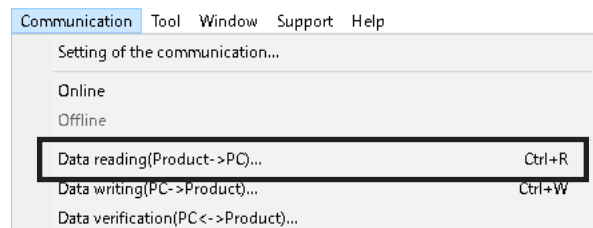

2) Click [OK].

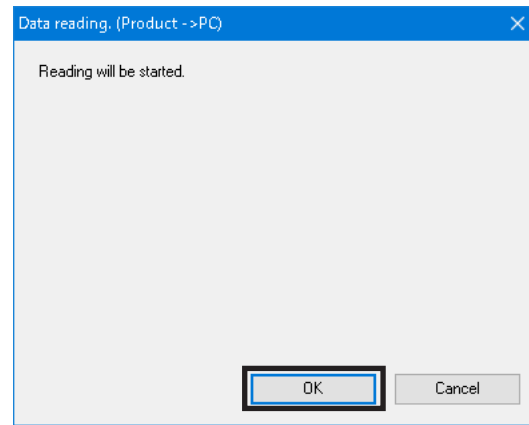

3) After it is completed, click [OK].
The read data is shown on the screen.

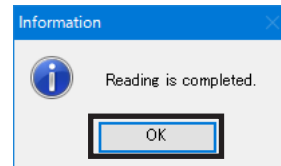

6. Check whether the copied data is updated on the unit information monitor window.

	Active	Driver parameter	ABZO (fixed)
Mechanism settings	ABZO	Prioritize ABZO setting	
Electronic gear A	62416	62416	62416
Electronic gear B	46298	46298	46298
Motor rotation direction	Positive side=Clockwise	Positive side=Clockwise	Positive side=Clockwise
Mechanism type	mm	mm	mm
Mechanism lead [mm]	0.742 [mm]		
Mechanism lead pitch	742	742	742
Mechanism lead decimal digit setting	×0.001 [mm]	×0.001 [mm]	×0.001 [mm]
Mechanism stroke	100 [mm]		100 [mm]
Magnetic brake	None		None

Note

- If the driver is required to restore to the factory setting, select "Restored to the factory setting" under the "Communication" menu to initialize.
- After restoring to the factory setting, copy the ABZO information (fixed value) to the driver again.

1-3 Parameter list (initial value)

Parameters of the rack and pinion motor are set as shown below at the time of shipment.

The box (●) in the model name indicates **B** (horizontal to mounting foot surface) or **F** (vertical to mounting foot surface) representing the rack moving direction.

■ AC power input type LM2

● Product specifications

Name	LM2●500	LM2●90
Lead	9.997 [mm]	1.868 [mm]
Minimum travel amount *	0.01 [mm]	0.001 [mm]

* The minimum travel amount is determined by the "Electronic gear" parameter and the ball screw lead.

● Upper limit value of setting



If a value exceeding the upper limit value is set to start operation, an alarm of operation data error is generated. The upper limit value can also be checked using the unit information monitor window (mechanism protection parameter) of the **MEXE02**.

Name	LM2●500		LM2●90	
	Unit of travel amount: mm	Unit of travel amount: step	Unit of travel amount: mm	Unit of travel amount: step
Maximum starting speed	10 [mm/s]	1,000 [Hz]	1 [mm/s]	1,000 [Hz]
Maximum operating speed	500 [mm/s]	50,000 [Hz]	90 [mm/s]	90,000 [Hz]
Maximum pushing speed	6 [mm/s]	600 [Hz]	6 [mm/s]	6,000 [Hz]
Maximum pushing return-to-home speed	6 [mm/s]	600 [Hz]	6 [mm/s]	6,000 [Hz]
Maximum push current *	54 [%]		22 [%]	

* It is the upper limit value when push-motion return-to-home operation is performed. When push-motion operation is performed, check the upper limit value with the graph on p.54.

● Motor & mechanism parameters

Name	LM2●500		LM2●90	
	Unit of travel amount: mm	Unit of travel amount: step	Unit of travel amount: mm	Unit of travel amount: step
Mechanism settings *1	Prioritize ABZO setting			
Electronic gear A *1	49,940		30,774	
Electronic gear B *1	49,927		57,492	
Motor rotation direction *2	Positive side=counterclockwise			
Mechanism lead *1	9,997		1,868	
Mechanism lead decimal digit setting *1	×0.001 [mm]		×0.001 [mm]	
Initial coordinate generation & wrap coordinate setting	Prioritize ABZO setting			
Initial coordinate generation & wrap setting range	1,800 [rev]			
Initial coordinate generation & wrap range offset ratio	50 [%]			
Wrap setting	Disable			
JOG/HOME/ZHOME operation setting	Prioritize ABZO setting			
(JOG) Operating speed	10.00 [mm/s]	1,000 [Hz]	9.995 [mm/s]	9,995 [Hz]

Name	LM2●500		LM2●90	
	Unit of travel amount: mm	Unit of travel amount: step	Unit of travel amount: mm	Unit of travel amount: step
(JOG) Acceleration/ deceleration	0.50000 [m/s ²]	50.000 [kHz/s]	0.049994 [m/s ²]	49.994 [kHz/s]
(JOG) Starting speed	5.000 [mm/s]	500 [Hz]	0.996 [mm/s]	996 [Hz]
(JOG) Operating speed (high)	49.99 [mm/s]	4,999 [Hz]	19.990 [mm/s]	19,990 [Hz]
(ZHOME) Operating speed	99.97 [mm/s]	9,997 [Hz]	19.990 [mm/s]	19,990 [Hz]
(ZHOME) Acceleration/ deceleration	0.49984 [m/s ²]	49.984 [kHz/s]	0.049984 [m/s ²]	49.984 [kHz/s]
(ZHOME) Starting speed	5.00 [mm/s]	500 [Hz]	0.996 [mm/s]	996 [Hz]
(HOME) Home-seeking mode	Push			
(HOME) Starting direction	Negative side			
(HOME) Acceleration/ deceleration	0.50000 [m/s ²]	50.000 [kHz/s]	0.049820 [m/s ²]	49.820 [kHz/s]
(HOME) Starting speed	5.00 [mm/s]	500 [Hz]	0.996 [mm/s]	996 [Hz]
(HOME) Operating speed	6.00 [mm/s]	600 [Hz]	5.978 [mm/s]	5,978 [Hz]
(HOME) Last speed	5.00 [mm/s]	500 [Hz]	0.996 [mm/s]	996 [Hz]
(HOME) Backward steps in 2 sensor home-seeking	5.00 [mm]	500 [step]	4.999 [mm]	4,999 [step]
(HOME) Operating amount in uni-directional home- seeking	5.00 [mm]	500 [step]	4.999 [mm]	4,999 [step]
(HOME) Operating current for push-home-seeking *3	54 [%]		22 [%]	
(HOME) Backward steps in push-home-seeking	5.00 [mm]	500 [step]	4.999 [mm]	4,999 [step]

*1 If the parameter is changed, the unit of travel amount will change from "mm" to "step." Once the unit of travel amount changed to "step," it cannot return to "mm."

*2 When the "Motor rotation direction" parameter is changed, select "Positive side=clockwise (the driver parameter is applied)" or "Positive side=counterclockwise (the driver parameter is applied)." If "Positive side=clockwise" or "Positive side=counterclockwise" is selected, the unit of travel amount will change from "mm" to "step."

*3 When performing push-motion return-to-home operation, use the rack and pinion motor with the operating current of the factory setting as much as possible. If the operating current smaller than the factory setting is set, the TLC output may be turned ON before push motion is complete, causing push-motion return-to-home operation to end at an unexpected position.

■ AC power input type LM4

● Product specifications

Name	LM4●500	LM4●40
Lead	10.009 [mm]	0.742 [mm]
Minimum travel amount *	0.01 [mm]	0.001 [mm]

* The minimum travel amount is determined by the "Electronic gear" parameter and the ball screw lead.

● Upper limit value of setting



If a value exceeding the upper limit value is set to start operation, an alarm of operation data error is generated. The upper limit value can also be checked using the unit information monitor window (mechanism protection parameter) of the **MEXE02**.

Name	LM4●500		LM4●40	
	Unit of travel amount: mm	Unit of travel amount: step	Unit of travel amount: mm	Unit of travel amount: step
Maximum starting speed	10 [mm/s]	1,000 [Hz]	1 [mm/s]	1,000 [Hz]
Maximum operating speed	500 [mm/s]	50,000 [Hz]	40 [mm/s]	40,000 [Hz]
Maximum pushing speed	6 [mm/s]	600 [Hz]	6 [mm/s]	6,000 [Hz]
Maximum pushing return-to-home speed	6 [mm/s]	600 [Hz]	6 [mm/s]	6,000 [Hz]
Maximum push current *	47 [%]		40 [%]	

* It is the upper limit value when push-motion return-to-home operation is performed. When push-motion operation is performed, check the upper limit value with the graph on p.54.

● Motor & mechanism parameters

Name	LM4●500		LM4●40	
	Unit of travel amount: mm	Unit of travel amount: step	Unit of travel amount: mm	Unit of travel amount: step
Mechanism settings *1	Prioritize ABZO setting			
Electronic gear A *1	64,610		62,416	
Electronic gear B *1	64,667		46,298	
Motor rotation direction *2	Positive side=clockwise			
Mechanism lead *1	10,009		742	
Mechanism lead decimal digit setting *1	×0.001 [mm]		×0.001 [mm]	
Initial coordinate generation & wrap coordinate setting	Prioritize ABZO setting			
Initial coordinate generation & wrap setting range	1,800 [rev]			
Initial coordinate generation & wrap range offset ratio *3	50 [%]			
Wrap setting	Disable			
JOG/HOME/ZHOME operation setting	Prioritize ABZO setting			
(JOG) Operating speed	9.84 [mm/s]	984 [Hz]	9.989 [mm/s]	9,989 [Hz]
(JOG) Acceleration/ deceleration	0.48400 [m/s ²]	48.400 [kHz/s]	0.050000 [m/s ²]	50.000 [kHz/s]
(JOG) Starting speed	5.00 [mm/s]	500 [Hz]	0.989 [mm/s]	989 [Hz]
(JOG) Operating speed (high)	49.88 [mm/s]	4,988 [Hz]	19.991 [mm/s]	19,991 [Hz]
(ZHOME) Operating speed	99.92 [mm/s]	9,992 [Hz]	19.991 [mm/s]	19,991 [Hz]
(ZHOME) Acceleration/ deceleration	0.49957 [m/s ²]	49.957 [kHz/s]	0.049874 [m/s ²]	49.874 [kHz/s]

Name	LM4●500		LM4●40	
	Unit of travel amount: mm	Unit of travel amount: step	Unit of travel amount: mm	Unit of travel amount: step
(ZHOME) Starting speed	5.00 [mm/s]	500 [Hz]	0.989 [mm/s]	989 [Hz]
(HOME) Home-seeking mode	Push			
(HOME) Starting direction	Negative side			
(HOME) Acceleration/ deceleration	0.42000 [m/s ²]	42.000 [kHz/s]	0.049574 [m/s ²]	49.574 [kHz/s]
(HOME) Starting speed	5.00 [mm/s]	500 [Hz]	0.989 [mm/s]	989 [Hz]
(HOME) Operating speed	5.84 [mm/s]	584 [Hz]	5.996 [mm/s]	5,996 [Hz]
(HOME) Last speed	5.00 [mm/s]	500 [Hz]	0.989 [mm/s]	989 [Hz]
(HOME) Backward steps in 2 sensor home-seeking	5.00 [mm]	500 [step]	5.000 [mm]	5,000 [step]
(HOME) Operating amount in uni-directional home- seeking	5.00 [mm]	500 [step]	5.000 [mm]	5,000 [step]
(HOME) Operating current for push-home-seeking *4	47 [%]		40 [%]	
(HOME) Backward steps in push-home-seeking	5.00 [mm]	500 [step]	5.000 [mm]	5,000 [step]

*1 If the parameter is changed, the unit of travel amount will change from "mm" to "step." Once the unit of travel amount changed to "step," it cannot return to "mm."

*2 When the "Motor rotation direction" parameter is changed, select "Positive side=clockwise (the driver parameter is applied)" or "Positive side=counterclockwise (the driver parameter is applied)." If "Positive side=clockwise" or "Positive side=counterclockwise" is selected, the unit of travel amount will change from "mm" to "step."

*3 To perform absolute positioning operation, changing the parameter is required depending on the product used. Refer to "2-1 Absolute positioning operation" on p.46 for details.

*4 When performing push-motion return-to-home operation, use the rack and pinion motor with the operating current of the factory setting as much as possible. If the operating current smaller than the factory setting is set, the TLC output may be turned ON before push motion is complete, causing push-motion return-to-home operation to end at an unexpected position.

■ DC power input type LM2

● Product specifications

Name	LM2●200	LM2●50
Lead	9.997 [mm]	1.868 [mm]
Minimum travel amount *	0.01 [mm]	0.001 [mm]

* The minimum travel amount is determined by the "Electronic gear" parameter and the ball screw lead.

● Upper limit value of setting



If a value exceeding the upper limit value is set to start operation, an alarm of operation data error is generated. The upper limit value can also be checked using the unit information monitor window (mechanism protection parameter) of the **MEXE02**.

Name	LM2●200		LM2●50	
	Unit of travel amount: mm	Unit of travel amount: step	Unit of travel amount: mm	Unit of travel amount: step
Maximum starting speed	10 [mm/s]	1,000 [Hz]	1 [mm/s]	1,000 [Hz]
Maximum operating speed	250 [mm/s]	25,000 [Hz]	60 [mm/s]	60,000 [Hz]
Maximum pushing speed	6 [mm/s]	600 [Hz]	6 [mm/s]	6,000 [Hz]
Maximum pushing return-to-home speed	6 [mm/s]	600 [Hz]	6 [mm/s]	6,000 [Hz]
Maximum push current *	56 [%]		24 [%]	

* It is the upper limit value when push-motion return-to-home operation is performed. When push-motion operation is performed, check the upper limit value with the graph on p.55.

● Motor & mechanism parameters

Name	LM2●200		LM2●50	
	Unit of travel amount: mm	Unit of travel amount: step	Unit of travel amount: mm	Unit of travel amount: step
Mechanism settings *1	Prioritize ABZO setting			
Electronic gear A *1	49,940		30,774	
Electronic gear B *1	49,927		57,492	
Motor rotation direction *2	Positive side=counterclockwise			
Mechanism lead *1	9,997		1,868	
Mechanism lead decimal digit setting *1	×0.001 [mm]		×0.001 [mm]	
Initial coordinate generation & wrap coordinate setting	Prioritize ABZO setting			
Initial coordinate generation & wrap setting range	1,800 [rev]			
Initial coordinate generation & wrap range offset ratio	50 [%]			
Wrap setting	Disable			
JOG/HOME/ZHOME operation setting	Prioritize ABZO setting			
(JOG) Operating speed	10.00 [mm/s]	1,000 [Hz]	9.995 [mm/s]	9,995 [Hz]
(JOG) Acceleration/ deceleration	0.50000 [m/s ²]	50.000 [kHz/s]	0.049994 [m/s ²]	49.994 [kHz/s]
(JOG) Starting speed	5.000 [mm/s]	500 [Hz]	0.996 [mm/s]	996 [Hz]
(JOG) Operating speed (high)	49.99 [mm/s]	4,999 [Hz]	19.990 [mm/s]	19,990 [Hz]
(ZHOME) Operating speed	99.97 [mm/s]	9,997 [Hz]	19.990 [mm/s]	19,990 [Hz]
(ZHOME) Acceleration/ deceleration	0.49984 [m/s ²]	49.984 [kHz/s]	0.049984 [m/s ²]	49.984 [kHz/s]

Name	LM2●200		LM2●50	
	Unit of travel amount: mm	Unit of travel amount: step	Unit of travel amount: mm	Unit of travel amount: step
(ZHOME) Starting speed	5.00 [mm/s]	500 [Hz]	0.996 [mm/s]	996 [Hz]
(HOME) Home-seeking mode	Push			
(HOME) Starting direction	Negative side			
(HOME) Acceleration/ deceleration	0.50000 [m/s ²]	50.000 [kHz/s]	0.049820 [m/s ²]	49.820 [kHz/s]
(HOME) Starting speed	5.00 [mm/s]	500 [Hz]	0.996 [mm/s]	996 [Hz]
(HOME) Operating speed	6.00 [mm/s]	600 [Hz]	5.978 [mm/s]	5,978 [Hz]
(HOME) Last speed	5.00 [mm/s]	500 [Hz]	0.996 [mm/s]	996 [Hz]
(HOME) Backward steps in 2 sensor home-seeking	5.00 [mm]	500 [step]	4.999 [mm]	4,999 [step]
(HOME) Operating amount in uni-directional home- seeking	5.00 [mm]	500 [step]	4.999 [mm]	4,999 [step]
(HOME) Operating current for push-home-seeking *3	56 [%]		24 [%]	
(HOME) Backward steps in push-home-seeking	5.00 [mm]	500 [step]	4.999 [mm]	4,999 [step]

*1 If the parameter is changed, the unit of travel amount will change from "mm" to "step." Once the unit of travel amount changed to "step," it cannot return to "mm."

*2 When the "Motor rotation direction" parameter is changed, select "Positive side=clockwise (the driver parameter is applied)" or "Positive side=counterclockwise (the driver parameter is applied)." If "Positive side=clockwise" or "Positive side=counterclockwise" is selected, the unit of travel amount will change from "mm" to "step."

*3 When performing push-motion return-to-home operation, use the rack and pinion motor with the operating current of the factory setting as much as possible. If the operating current smaller than the factory setting is set, the TLC output may be turned ON before push motion is complete, causing push-motion return-to-home operation to end at an unexpected position.

■ DC power input type LM4

● Product specifications

Name	LM4●150	LM4●20
Lead	10.009 [mm]	0.742 [mm]
Minimum travel amount *	0.01 [mm]	0.001 [mm]

* The minimum travel amount is determined by the "Electronic gear" parameter and the ball screw lead.

● Upper limit value of setting



If a value exceeding the upper limit value is set to start operation, an alarm of operation data error is generated. The upper limit value can also be checked using the unit information monitor window (mechanism protection parameter) of the **MEXE02**.

Name	LM4●150		LM4●20	
	Unit of travel amount: mm	Unit of travel amount: step	Unit of travel amount: mm	Unit of travel amount: step
Maximum starting speed	10 [mm/s]	1,000 [Hz]	1 [mm/s]	1,000 [Hz]
Maximum operating speed	250 [mm/s]	25,000 [Hz]	25 [mm/s]	25,000 [Hz]
Maximum pushing speed	6 [mm/s]	600 [Hz]	6 [mm/s]	6,000 [Hz]
Maximum pushing return-to-home speed	6 [mm/s]	600 [Hz]	6 [mm/s]	6,000 [Hz]
Maximum push current *	52 [%]		28 [%]	

* It is the upper limit value when push-motion return-to-home operation is performed. When push-motion operation is performed, check the upper limit value with the graph on p.55.

● Motor & mechanism parameters

Name	LM4●150		LM4●20	
	Unit of travel amount: mm	Unit of travel amount: step	Unit of travel amount: mm	Unit of travel amount: step
Mechanism settings *1	Prioritize ABZO setting			
Electronic gear A *1	64,610		62,416	
Electronic gear B *1	64,667		46,298	
Motor rotation direction *2	Positive side=clockwise			
Mechanism lead *1	10,009		742	
Mechanism lead decimal digit setting *1	×0.001 [mm]		×0.001 [mm]	
Initial coordinate generation & wrap coordinate setting	Prioritize ABZO setting			
Initial coordinate generation & wrap setting range	1,800 [rev]			
Initial coordinate generation & wrap range offset ratio *3	50 [%]			
Wrap setting	Disable			
JOG/HOME/ZHOME operation setting	Prioritize ABZO setting			
(JOG) Operating speed	9.84 [mm/s]	984 [Hz]	4.995 [mm/s]	4,995 [Hz]
(JOG) Acceleration/ deceleration	0.48400 [m/s ²]	48.400 [kHz/s]	0.050075 [m/s ²]	50.075 [kHz/s]
(JOG) Starting speed	5.00 [mm/s]	500 [Hz]	0.989 [mm/s]	989 [Hz]
(JOG) Operating speed (high)	49.88 [mm/s]	4,988 [Hz]	9.989 [mm/s]	9,989 [Hz]
(ZHOME) Operating speed	99.92 [mm/s]	9,992 [Hz]	9.989 [mm/s]	9,989 [Hz]
(ZHOME) Acceleration/ deceleration	0.49957 [m/s ²]	49.957 [kHz/s]	0.050000 [m/s ²]	50.000 [kHz/s]

Name	LM4●150		LM4●20	
	Unit of travel amount: mm	Unit of travel amount: step	Unit of travel amount: mm	Unit of travel amount: step
(ZHOME) Starting speed	5.00 [mm/s]	500 [Hz]	0.989 [mm/s]	989 [Hz]
(HOME) Home-seeking mode	Push			
(HOME) Starting direction	Negative side			
(HOME) Acceleration/ deceleration	0.42000 [m/s ²]	42.000 [kHz/s]	0.049574 [m/s ²]	49.574 [kHz/s]
(HOME) Starting speed	5.00 [mm/s]	500 [Hz]	0.989 [mm/s]	989 [Hz]
(HOME) Operating speed	5.84 [mm/s]	584 [Hz]	5.996 [mm/s]	5,996 [Hz]
(HOME) Last speed	5.00 [mm/s]	500 [Hz]	0.989 [mm/s]	989 [Hz]
(HOME) Backward steps in 2 sensor home-seeking	5.00 [mm]	500 [step]	5.000 [mm]	5,000 [step]
(HOME) Operating amount in uni-directional home- seeking	5.00 [mm]	500 [step]	5.000 [mm]	5,000 [step]
(HOME) Operating current for push-home-seeking *4	52 [%]		28 [%]	
(HOME) Backward steps in push-home-seeking	5.00 [mm]	500 [step]	5.000 [mm]	5,000 [step]

*1 If the parameter is changed, the unit of travel amount will change from "mm" to "step." Once the unit of travel amount changed to "step," it cannot return to "mm."

*2 When the "Motor rotation direction" parameter is changed, select "Positive side=clockwise (the driver parameter is applied)" or "Positive side=counterclockwise (the driver parameter is applied)." If "Positive side=clockwise" or "Positive side=counterclockwise" is selected, the unit of travel amount will change from "mm" to "step."

*3 To perform absolute positioning operation, changing the parameter is required depending on the product used. Refer to "2-1 Absolute positioning operation" on p.46 for details.

*4 When performing push-motion return-to-home operation, use the rack and pinion motor with the operating current of the factory setting as much as possible. If the operating current smaller than the factory setting is set, the TLC output may be turned ON before push motion is complete, causing push-motion return-to-home operation to end at an unexpected position.

1-4 Changing the moving direction of rack

The following two methods are available to change the moving direction of the rack. Use them selectively in accordance with the intended use.

- To change the travel amount.
- To change the "Motor rotation direction" parameter.

CAUTION When the "Motor rotation direction" parameter is changed, select "Positive side=clockwise (the driver parameter is applied)" or "Positive side=counterclockwise (the driver parameter is applied)." The unit "mm" of travel amount can be used as it is. (It will not change to "step.") Note that the unit of travel amount will change from "mm" to "step" if "Positive side=clockwise" or "Positive side=counterclockwise" is selected.

- Note**
- If the driver is required to restore to the factory setting, select "Restored to the factory setting" under the "Communication" menu to initialize.
 - After restoring to the factory setting, copy the ABZO information (fixed value) to the driver again.

● Flow of change method

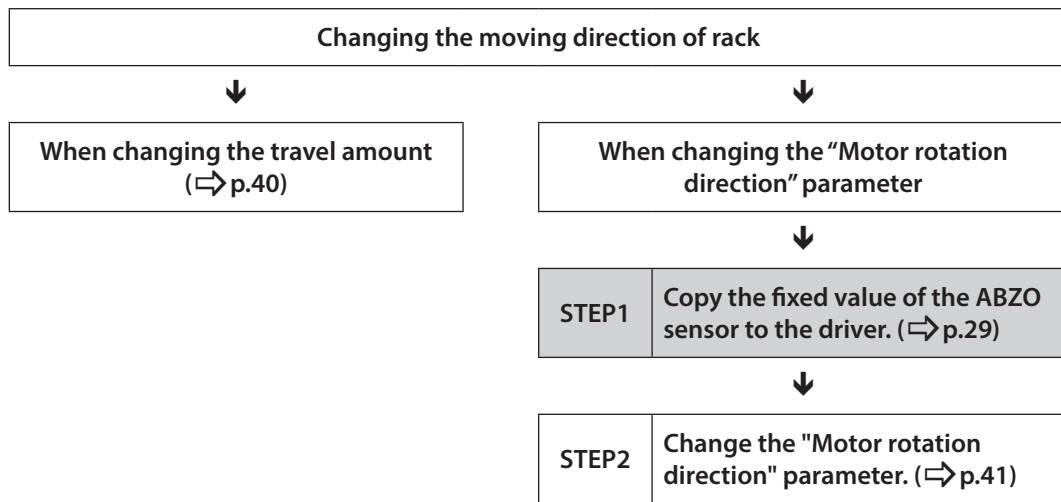

■ When changing the travel amount

The moving direction of the rack is set as shown below at the time of shipment.

The moving direction of the rack can be changed by the travel amount or the pulse input method.

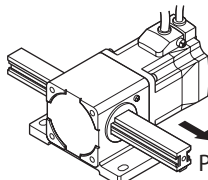
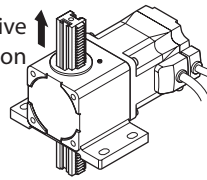
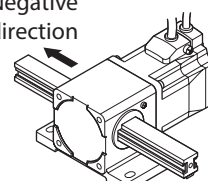
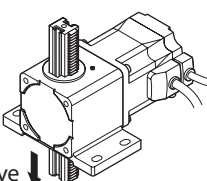
When setting the operation data	When inputting the pulse signal	Moving direction
Set the positive (+) value in travel amount	<ul style="list-style-type: none"> • 2-pulse input mode Input the pulse signal to the CW input • 1-pulse input mode Input the pulse signal to the PLS input when the DIR input is ON 	<div style="display: flex; justify-content: space-around;"> <div style="text-align: center;"> <p>B type</p>  <p>Positive direction</p> </div> <div style="text-align: center;"> <p>F type</p>  <p>Positive direction</p> </div> </div>
Set the negative (-) value in travel amount	<ul style="list-style-type: none"> • 2-pulse input mode Input the pulse signal to the CCW input • 1-pulse input mode Input the pulse signal to the PLS input when the DIR input is OFF 	<div style="display: flex; justify-content: space-around;"> <div style="text-align: center;"> <p>B type</p>  <p>Negative direction</p> </div> <div style="text-align: center;"> <p>F type</p>  <p>Negative direction</p> </div> </div>

■ When changing the “Motor rotation direction” parameter

1. Refer to p.29, and copy the ABZO information (fixed value) to the driver.

Note When the “Motor rotation direction” parameter is changed, be sure to copy the ABZO information (fixed value) to the driver first.

2. Click “Motor & mechanism (coordinates/JOG/home operation)” under “Parameter” in the tree view.
The motor & mechanism parameter is shown.

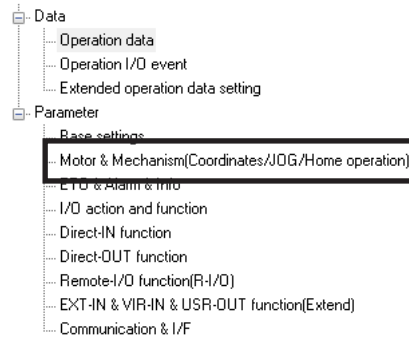

3. Change the "Motor rotation direction" parameter to "Positive side=counterclockwise (the driver parameter is applied)" or "Positive side=clockwise (the driver parameter is applied)."
The unit "mm" of travel amount can be used as it is. (It will not change to “step.”)

1	Mechanism settings	Prioritize ABZO setting
2	Electronic gear A	1
3	Electronic gear B	1
4	Motor rotation direction	Positive side=Counterclockwise (the driver parameter is applied)

Note If the “Motor rotation direction” parameter is changed to “Positive side=clockwise” or “Positive side= counterclockwise,” the unit of travel amount will change from “mm” to “step.”

unit of display step mm deg

Operation data Motor & Mechanism(Coordinates/JOG/Home operation)		
1	Mechanism settings	Prioritize ABZO setting
2	Electronic gear A	62416
3	Electronic gear B	46298
4	Motor rotation direction	Positive side=Counterclockwise

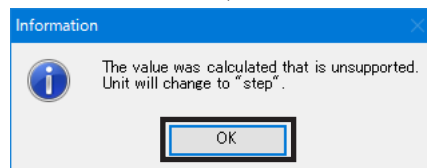

unit of display step mm deg

Operation data Motor & Mechanism(Coordinates/JOG/Home operation)		
1	Mechanism settings	Manual setting (use driver parameter)
2	Electronic gear A	62416
3	Electronic gear B	46298
4	Motor rotation direction	Positive side=Counterclockwise

4. Write the parameter to the driver in the following steps.

- 1) Click "Data writing" under the "Communication" menu or click the [Data writing] icon in the toolbar.

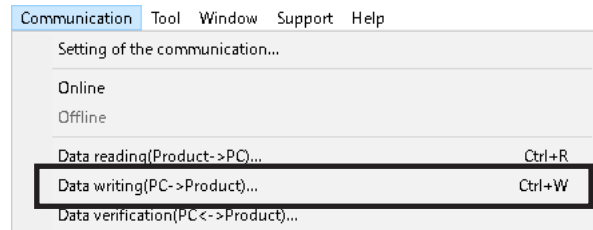

- 2) Select "All" in the data range, and click [OK].

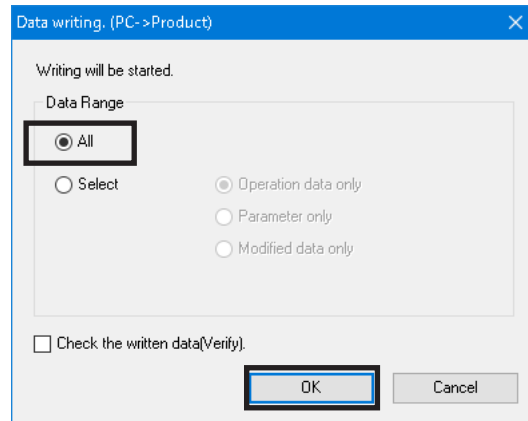

- 3) Click [Yes].
Writing parameter is started.

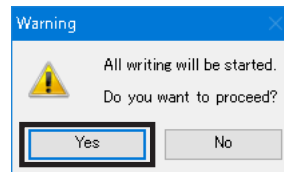

- 4) Click [Yes].
The parameter information is updated to the driver.

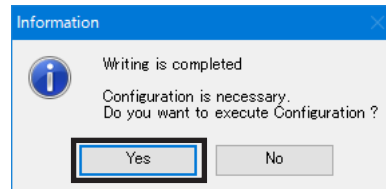

- 5) Click [Yes].

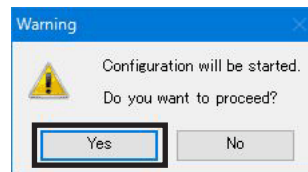

- 6) Click [OK].

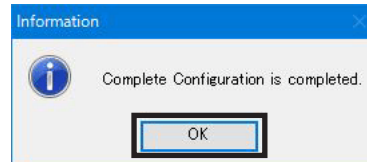

5. Check whether the changed parameter information is updated on the unit information monitor window.

	Active	Driver parameter	ABZO (fixed)
Mechanism settings	ABZO	Prioritize ABZO setting	
Electronic gear A	62416	62416	62416
Electronic gear B	46298	46298	46298
Motor rotation direction	Positive side=Counterclockwise	clockwise (the driver parameter is applied)	Positive side=Clockwise
Mechanism type	mm	mm	mm
Mechanism lead (pitch) [mm]	0.742 [mm]		
Mechanism lead	742	742	742
Mechanism lead decimal digit setting	×0.001 [mm]	×0.001 [mm]	×0.001 [mm]
Mechanism stroke	100 [mm]		100 [mm]
Magnetic brake	None		None
Gear ratio setting	1.00	1.00	1.00

1-5 Matching the resolution with the LAS Series

When the **LAS** Series used is replaced to the **L** Series, it is required to change the “Electronic gear” parameters in order to match the resolution with the **LAS** Series. Set the resolution in the following steps.

Note When the rack and pinion motor is used in combination with the pulse input type driver, do not change the SW1-No.1 of the function setting switch on the driver (factory setting: OFF). If the switch is set to ON, the electronic gear will not enable.

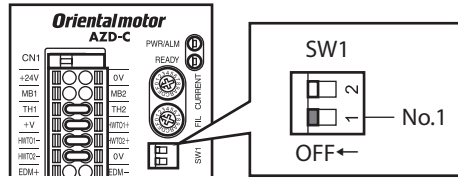

1. Refer to p.29, and copy the ABZO information (fixed value) to the driver.

Note When the “Electronic gear” parameters are changed, be sure to copy the ABZO information (fixed value) to the driver first.

2. Click “Motor & mechanism (coordinates/JOG/home operation)” under “Parameter” in the tree view. The motor & mechanism parameter is shown.

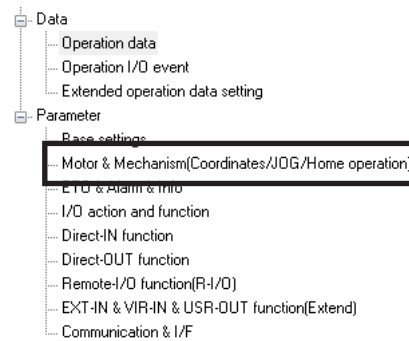

3. Change the "Mechanism settings" parameter to "Manual setting."

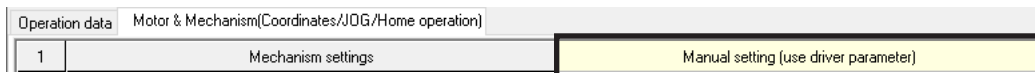

4. Click [OK].

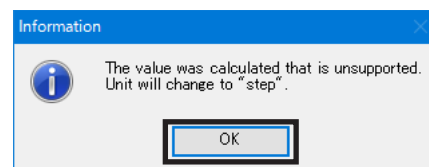

Note If the "Mechanism settings" parameter is changed to "Manual setting," the unit of travel amount will change from “mm” to “step.” Once the unit of travel amount changed to “step,” it cannot return to “mm.”

- Change the "Electronic gear" parameters.

1	Mechanism settings	Manual setting (use driver parameter)
2	Electronic gear A	1
3	Electronic gear B	5

Initial values for the LAS Series

Resolution	Electronic gear A	Electronic gear B	Motor rotation direction
500 P/R	2	1	Positive side=clockwise
1,000 P/R	1	1	
5,000 P/R	1	5	
10,000 P/R	1	10	

Note When the **LM2** is used, the motor rotation direction is changed to "Positive side=counterclockwise" if the ABZO information (fixed value) is copied to the driver. Therefore, to match the moving direction of the rack with the **LAS Series**, change the "Motor rotation direction" parameter to "Positive side=clockwise." (In the case of the **LM4**, there is no need to change the "Motor rotation direction" parameter.)

- Write the parameter to the driver in the following steps.

- Click "Data writing" under the "Communication" menu or click the [Data writing] icon in the toolbar.

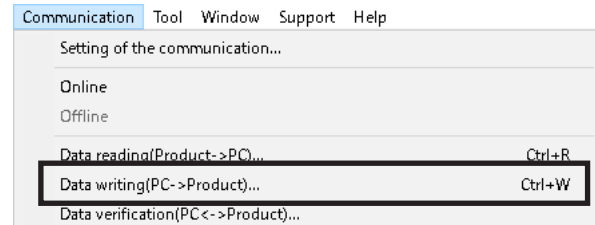

- Select "All" in the data range, and click [OK].

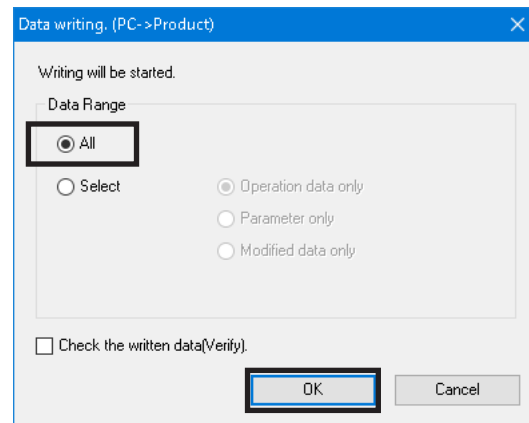

- Click [Yes].
Writing parameter is started.

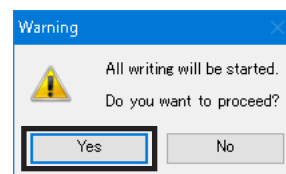

- Click [OK].

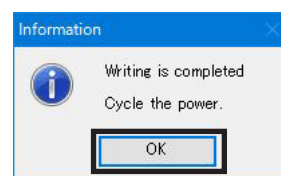

- 5) Turn on the control power supply again.
The parameter information is updated to the driver.

7. Check whether the changed parameter information is updated on the unit information monitor window.

	Active	Driver parameter	ABZO (fixed)
Mechanism settings	Driver parameter	Manual setting	
Electronic gear A	1	1	62416
Electronic gear B	5	5	46298
Motor rotation direction	Positive side=Clockwise	Positive side=Clockwise	Positive side=Clockwise

2 Operation

2-1 Absolute positioning operation

The motor of the **AZ** Series, which the **L** Series is equipped with, manages the absolute position by the ABZO sensor. The ABZO sensor stores the present position as the absolute position until the number of rotations of the motor output shaft exceeds 1,800 revolutions (± 900 revolutions) with reference to the home. Within this range, it keeps the present position even if the driver power is turned off.

However, if the product used applies the descriptions in the table next, the absolute position is lost when the power is turned off because the ABZO sensor exceeds the detectable range.

Therefore, by offsetting the range in which the absolute position can be detected from the home, it is necessary to change the "Initial coordinate generation & wrap coordinate setting" parameter so that the absolute position can be detected even if the travel amount exceed the value in the table.

Model *		Movable distance from home
AC power input type	LM4●40AZ■C-7 to LM4●40AZ■C-10	Up to 660 mm in positive direction or 660 mm in negative direction
DC power input type	LM4●20AZ■K-10	

* The box (●) in the model name indicates **B** (horizontal to mounting foot surface) or **F** (vertical to mounting foot surface) representing the rack moving direction.
The box (■) in the model name indicates **A** (standard) or **M** (with electromagnetic brake) representing the motor type.

Note The "Initial coordinate generation & wrap coordinate setting" parameter is not available for the SSCNET III/H compatible multi-axis driver. Therefore, do not combine **LM4●20AZ■K-10** with the SSCNET III/H compatible multi-axis driver.

memo Rack and pinion motors other than models described in the table can detect the present position by the ABZO sensor even if the maximum distance is operated.

● Reference picture of wrap offset

The following example shows when the stroke of the **LM4●40AZ■C-10** is offset. The figure is indicated by the rack length instead of the rack stroke. (unit: mm)
Numerical values after a decimal point are omitted.

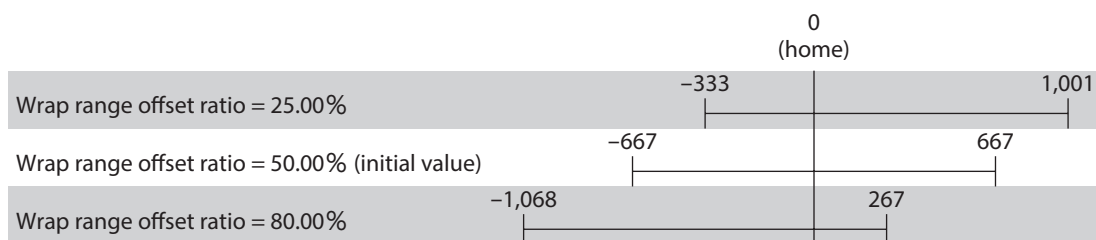

● Flow of wrap offset

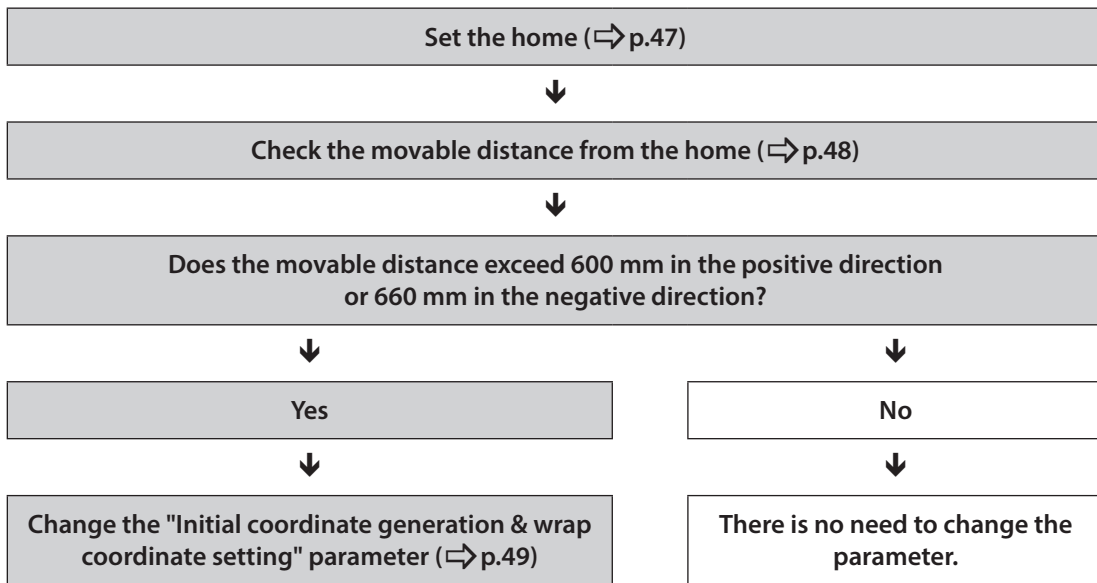

■ Home setting

1. Click the [Teaching, remote operation] short-cut button or click the [Teaching, remote operation] icon in the toolbar.
2. Click "Start the teaching remote operation."
3. Click [Yes].
4. Using the JOG operation buttons, move the rack to the home.
Adjust the position while checking "Command position (CPOS)" in the "Driver status" field.

The screenshots illustrate the steps for home setting:

- Step 1:** The 'Operation' menu is open, and 'Teaching, remote operation' is selected.
- Step 2:** In the 'Start the teaching remote operation.' dialog, the checkbox is checked.
- Step 3:** A warning dialog box appears: 'The teaching remote operation will be started. Do you want to proceed?' The 'Yes' button is selected.
- Step 4:** The 'Driver Status' window is shown. The 'Command Position(CPOS)' field is highlighted and shows '0.000 [mm]'. Below it, the 'JOG operation buttons' (left arrow, right arrow, stop, and home buttons) are highlighted.

- Click [Position preset].
The home is set.

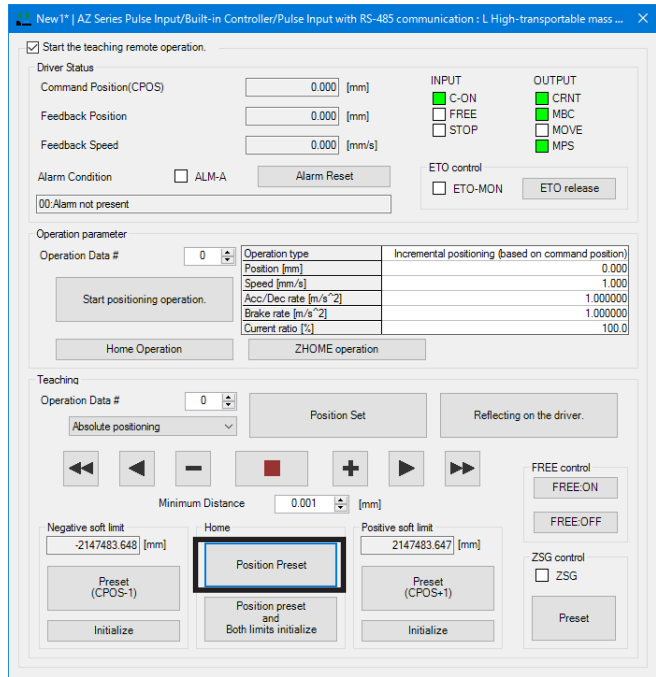

■ Checking the movable distance

Check the movable distance by the **MEXE02** or actual measurement.

● Check by MEXE02

- Using the JOG operation buttons, move the rack from the home.

JOG operation buttons

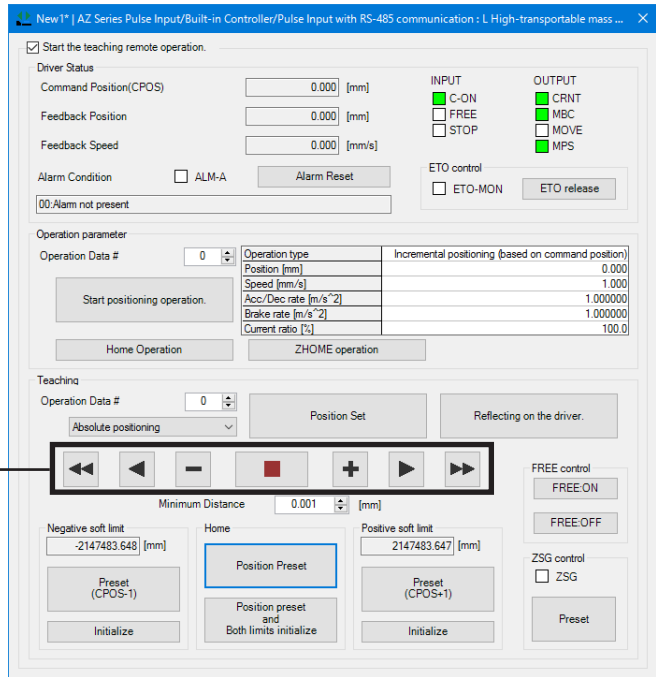

- Check "Feedback position" in the "Driver status" field.

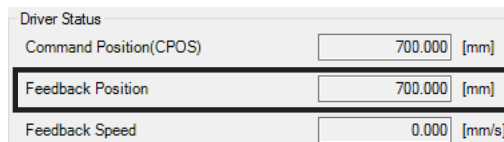

● Check by actual measurement

- Using the JOG operation buttons, move the rack to a desired position.

JOG operation buttons

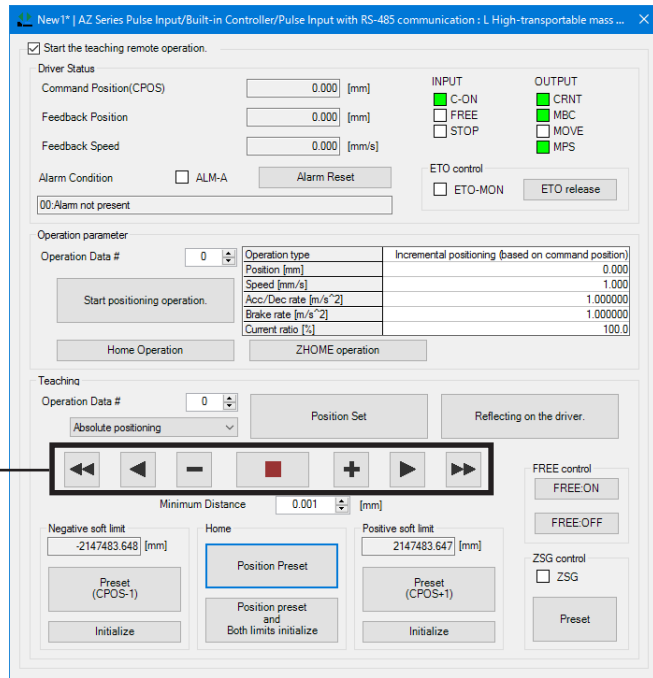

- Measure the distance from the end face of the rack to the rack bushing.

■ Changing the parameter

- Refer to p.29, and copy the ABZO information (fixed value) to the driver.



When the "Initial coordinate generation & wrap coordinate setting" parameter is changed, be sure to copy the ABZO information (fixed value) to the driver first.

- Click "Motor & mechanism (coordinates/JOG/home operation)" under "Parameter" in the tree view. The motor & mechanism parameter is shown.

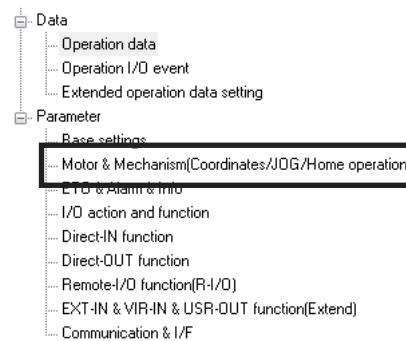

- Change the "Initial coordinate generation & wrap coordinate setting" parameter to "Manual setting."

10	Initial coordinate generation & wrap coordinate setting	Manual setting (use driver parameter)
11	Initial coordinate generation & wrap setting range [rev]	1800.0
12	Initial coordinate generation & wrap range offset ratio [%]	50.00
13	Initial coordinate generation & wrap range offset value [mm]	0
14	Wrap setting	Disable
15	The number of the RND-ZERO output in wrap range	1800

- Select a value from the following table, and set in the "Initial coordinate generation & wrap range offset ratio" parameter.

10	Initial coordinate generation & wrap coordinate setting	Manual setting (use driver parameter)
11	Initial coordinate generation & wrap setting range [rev]	1800.0
12	Initial coordinate generation & wrap range offset ratio [%]	65.00
13	Initial coordinate generation & wrap range offset value [mm]	0
14	Wrap setting	Disable
15	The number of the RND-ZERO output in wrap range	1800

Positive direction

Movable distance from home (mm)	Setting value of parameter (%)
-660 to 660	50 (initial value)
661 to 700	45
701 to 750	40
751 to 800	35
801 to 850	30
851 to 900	25
901 or more	20

Negative direction

Movable distance from home (mm)	Setting value of parameter (%)
-660 to 660	50 (initial value)
-661 to -700	55
-701 to -750	60
-751 to -800	65
-801 to -850	70
-851 to -900	75
-901 or more	80

■ Writing to the driver

- Click "Data writing" under the "Communication" menu or click the [Data writing] icon in the toolbar.

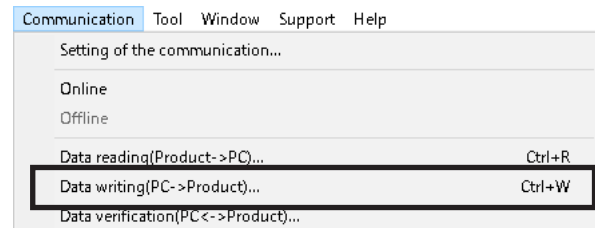

- Select "All" in the data range, and click [OK].

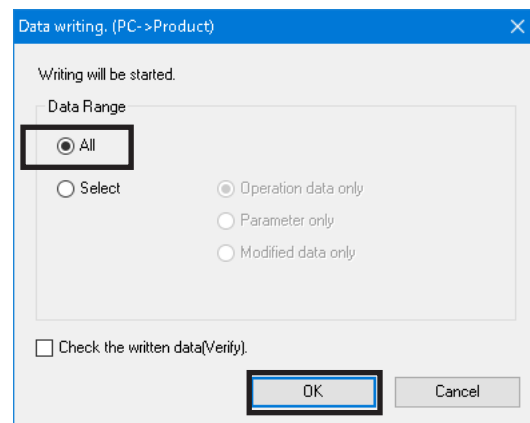

- Click [Yes].
Writing parameter is started.

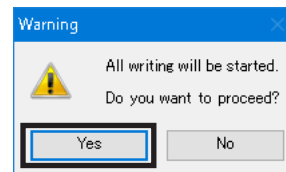

- Click [OK].

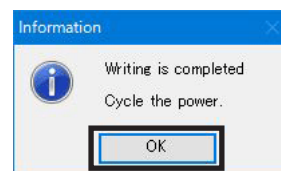

5. Turn on the control power supply again.
The parameter information is updated to the driver.
6. Check whether the changed parameter information is updated on the unit information monitor window.

	Active	Driver parameter	ABZO (fixed)
Mechanism settings	ABZO	Prioritize ABZO setting	
Electronic gear A	62416	62416	62416
Electronic gear B	46298	46298	46298
Motor rotation direction	Positive side=Clockwise	Positive side=Clockwise	Positive side=Clockwise
Mechanism type	mm	mm	mm
Mechanism lead [mm]	0.742		
Mechanism lead pitch	742	742	742
Mechanism lead decimal digit setting	×0.001 [mm]	×0.001 [mm]	×0.001 [mm]
Mechanism stroke	1000 [mm]		1000 [mm]
Magnetic brake	None		None
Gear ratio setting	1.00	1.00	1.00
Initial coordinate generation & wrap coordinate setting	Driver parameter	Manual setting	Setting exists
Initial coordinate generation & wrap setting range	1800.0 [rev]	1800.0 [rev]	1800.0 [rev]
Initial coordinate generation & wrap range offset ratio	65.00 [%]	65.00 [%]	50.00 [%]
Initial coordinate generation & wrap range offset value	0.000 [mm]	0.000 [mm]	0.000 [mm]
Wrap setting	Disable	Disable	Disable
The number of the RND-ZERO output in wrap range	1800	1800	1800

■ **Setting example: When 770 mm is moved in the negative direction from the end face of the rack**

Setting of parameters

10	Initial coordinate generation & wrap coordinate setting	Manual setting (use driver parameter)
11	Initial coordinate generation & wrap setting range [rev]	1800.0
12	Initial coordinate generation & wrap range offset ratio [%]	65.00
13	Initial coordinate generation & wrap range offset value [mm]	0
14	Wrap setting	Disable
15	The number of the RND-ZERO output in wrap range	1800

Changing the offset ratio to 65% can detect the present position up to -800 mm.

Before changing the parameter

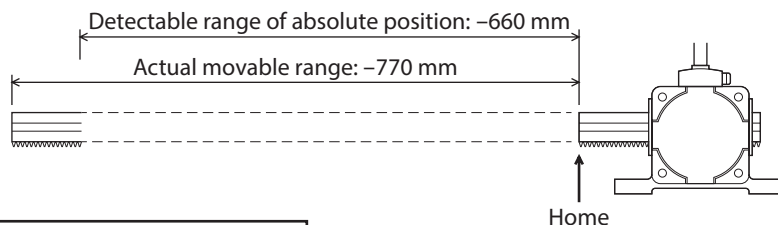

After changing the parameter

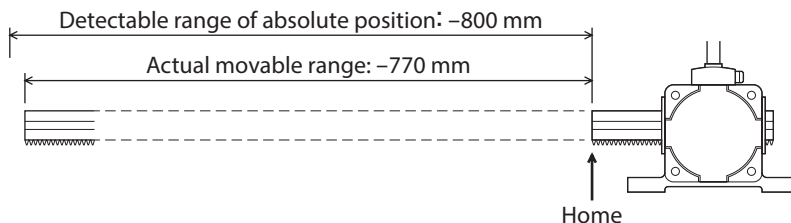

2-2 Return-to-home operation

Return-to-home is an operation that the reference position (home) to be the starting point is established when positioning operation is performed.

Return-to-home operation is performed to return to the home from the current position when the power supply is turned on or the positioning operation is completed.

Two types of return-to-home methods are available. One is a high-speed return-to-home operation, and the other is the return-to-home operation.

■ High-speed return-to-home operation

High-speed return-to-home operation is an operation to return to the mechanical home on the absolute position coordinate set in advance. Since the home is recognized by the ABZO sensor, return-to-home operation can be executed at the same speed as that of the normal positioning operation without using an external sensor.

When the ZHOME input is turned ON, high-speed return-to-home operation is started. The rack and pinion motor stops when the operation stop signal is turned ON while the motor is operating.

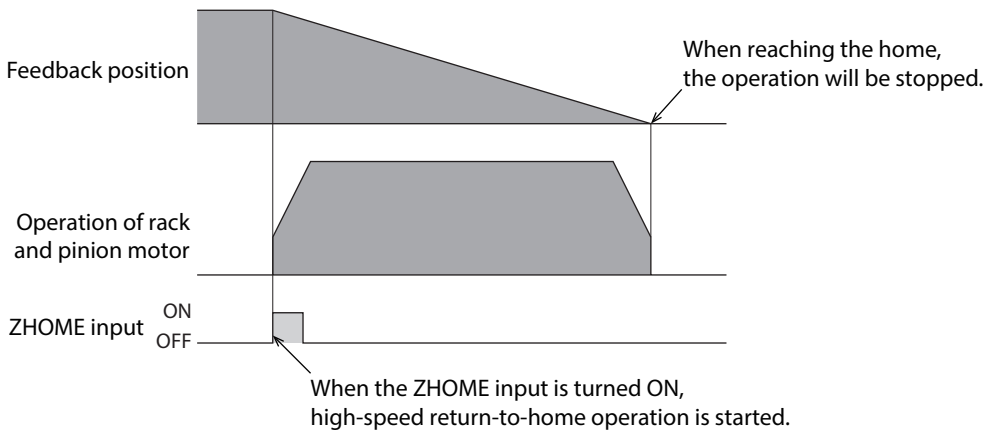

■ Return-to-home operation

Return-to-home operation is an operation to detect the home by using an external sensor.

A photomicrosensor set for detecting the home is also provided as our product. Refer to p.26 for the model name.

Return-to-home operation can be performed in the following four patterns. Refer to the **AZ Series OPERATING MANUAL Function Edition** for return-to-home methods other than the push mode.

Return-to-home method	Features
2-sensor mode	<ul style="list-style-type: none"> • Two external sensors are required • The operating speed is low (return-to-home starting speed)
3-sensor mode	<ul style="list-style-type: none"> • Three external sensors are required • The operating speed is high (return-to-home operation speed)
One-way rotation mode	<ul style="list-style-type: none"> • One external sensor is required • The operating speed is high (return-to-home operation speed) • Not rotate in the reverse direction
Push mode	<ul style="list-style-type: none"> • An external sensor is not required • The operating speed is high (return-to-home operation speed)

● Push mode

CAUTION When return-to-home operation is performed in the push mode, provide an external mechanism that the rack presses against within the range of the stroke. Pressing against exceeding the range of the stroke may result in injury or damage to equipment.

Operation

1. When push-motion return-to-home operation is performed, the rack moves to a mechanism.

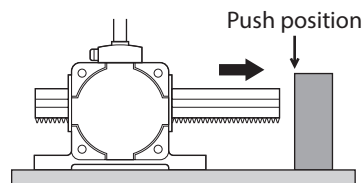

2. The rack presses against the mechanism.

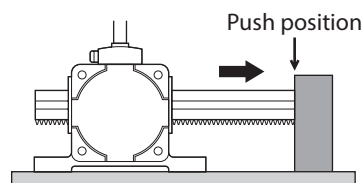

3. The rack returns to the set home and stops.

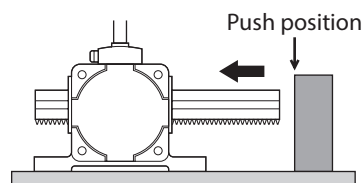

Push force

Set the push force of push-motion return-to-home operation as a percentage of the rated current. The upper limit value is set in the“(HOME) Operating current for push-home-seeking” parameter at the time of shipment. Do not set a value larger than the initial value.

AC power input type

Model *	Initial value (%)
LM2●500	54
LM2●90	22
LM4●500	47
LM4●40	40

DC power input type

Model *	Initial value (%)
LM2●200	56
LM2●50	24
LM4●150	52
LM4●20	28

* The box (●) in the model name indicates **B** (horizontal to mounting foot surface) or **F** (vertical to mounting foot surface) representing the rack moving direction.

Operating speed of push-motion return-to-home

The upper limit value of the push-motion return-to-home speed is 6 mm/s.

2-3 Push-motion operation

Push-motion operation is an operation that continuously pressurizes on a load when having pressed against it.

■ Setting of push force

The push force can be set in the “Operating current” of the operation data. The maximum push forces are as shown in the table.

The box (●) in the model name indicates **B** (horizontal to mounting foot surface) or **F** (vertical to mounting foot surface) representing the rack moving direction.

AC power input type

Model	Maximum push force [N (lb.)]	Operating current (%)
LM2●500	110 (24)	43
LM2●90	306 (68)	18
LM4●500	220 (49)	41
LM4●40	1,008 (220)	20

DC power input type

Model	Maximum push force [N (lb.)]	Operating current (%)
LM2●200	110 (24)	46
LM2●50	306 (68)	14
LM4●150	220 (49)	42
LM4●20	1,008 (220)	18

Note

- Set the operating current in order not to exceed the maximum push force. Performing push-motion operation with the current exceeding the maximum push force may cause damage to equipment or deterioration of specifications.
- Perform push-motion operation on an extension of the rack. Performing push-motion operation in a position deviated from the extension of the rack may cause damage to the rack and pinion motor.

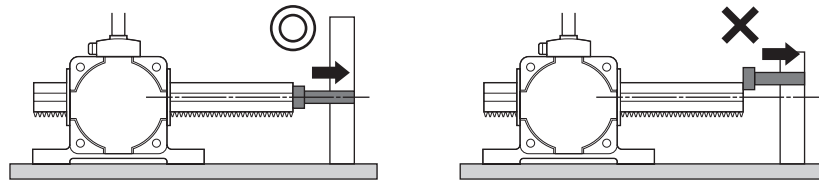

● Reference: Measurement result of the operating current and push force

The reference value of the push force is shown below.

Note

- The relationship between the operating current and push force varies depending on your load conditions such as jig. Check the actual push force using the actual equipment referring to the graph, and adjust the operating current.
- If the rack and pinion motor is used in a vertical direction, the actual transportable mass is a value obtained by subtracting the mass of the rack from the specification value.

AC power input type

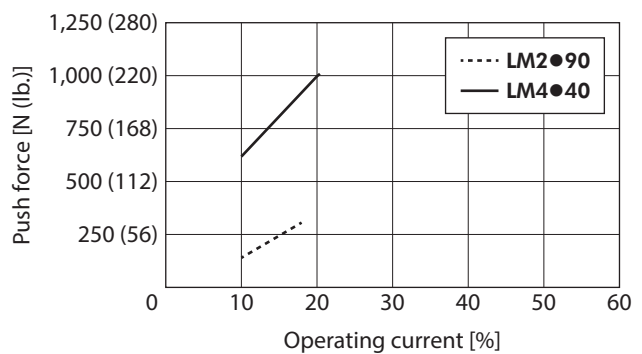
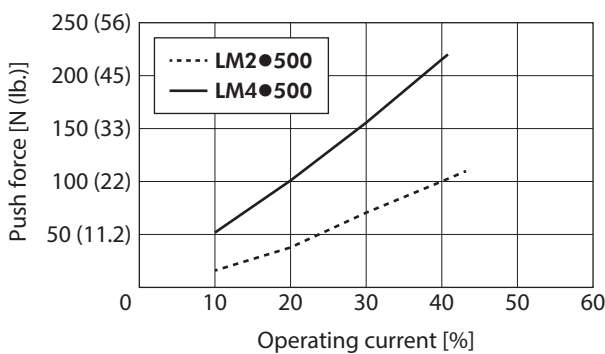

DC power input type

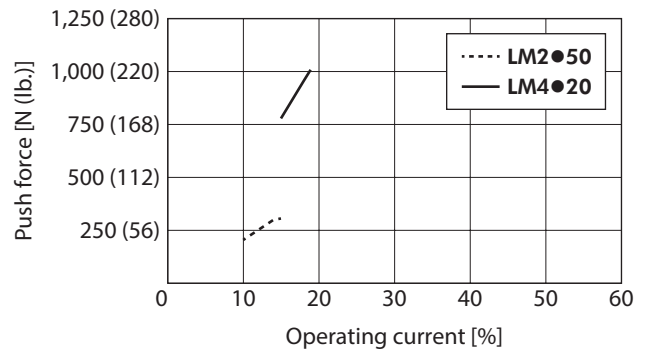
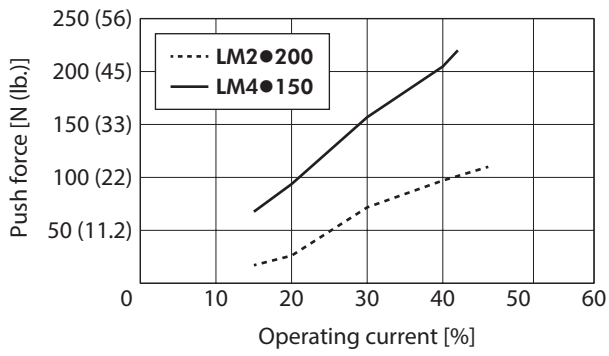

■ Push speed

The upper limit value of push speed is 6 mm/s.

3 Appendix

◆ Table of contents

1	Dimensions	58
1-1	LM2 B type.....	58
1-2	LM2 F type.....	58
1-3	LM4 B type.....	59
1-4	LM4 F type.....	59



1 Dimensions

This chapter describes dimensions for installation and storage of the rack and pinion motor.
For details, contact your nearest Oriental Motor sales office.

1-1 LM2 B type

Example: **LM2B90AZMC-8**
Mass: 3.8 kg (8.4 lb.)

Unit: mm (in.)

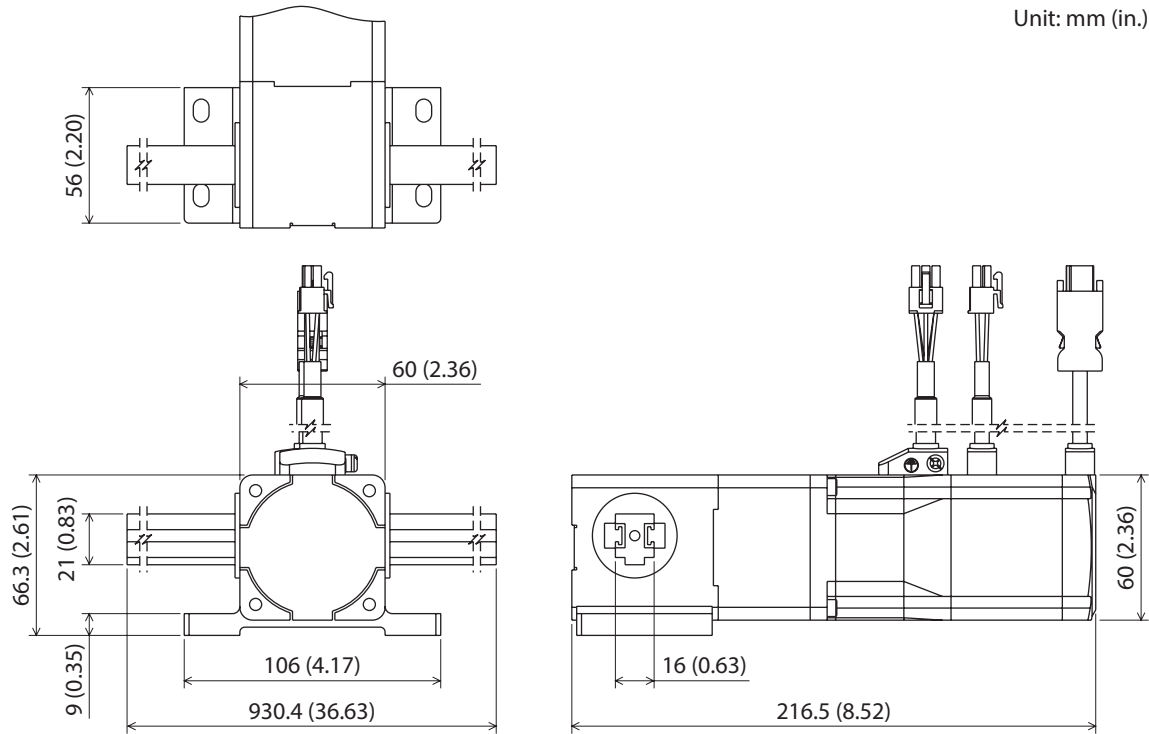

1-2 LM2 F type

Example: **LM2F90AZMC-8**
Mass: 3.8 kg (8.4 lb.)

Unit: mm (in.)

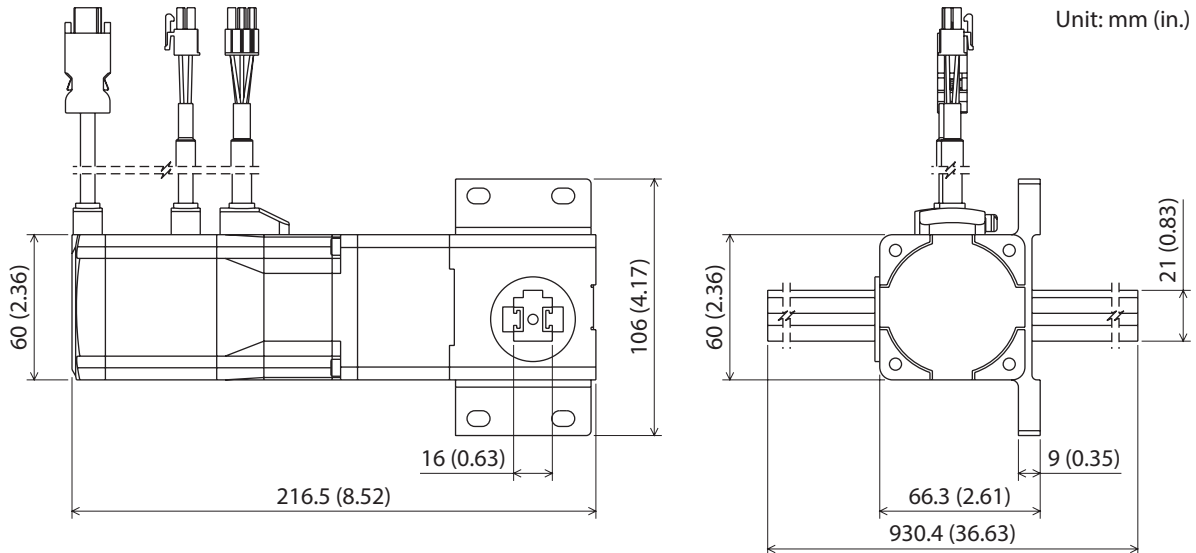

1-3 LM4 B type

Example: **LM4B40AZMC-10**
 Mass: 5.9 kg (13.0 lb.)

Unit: mm (in.)

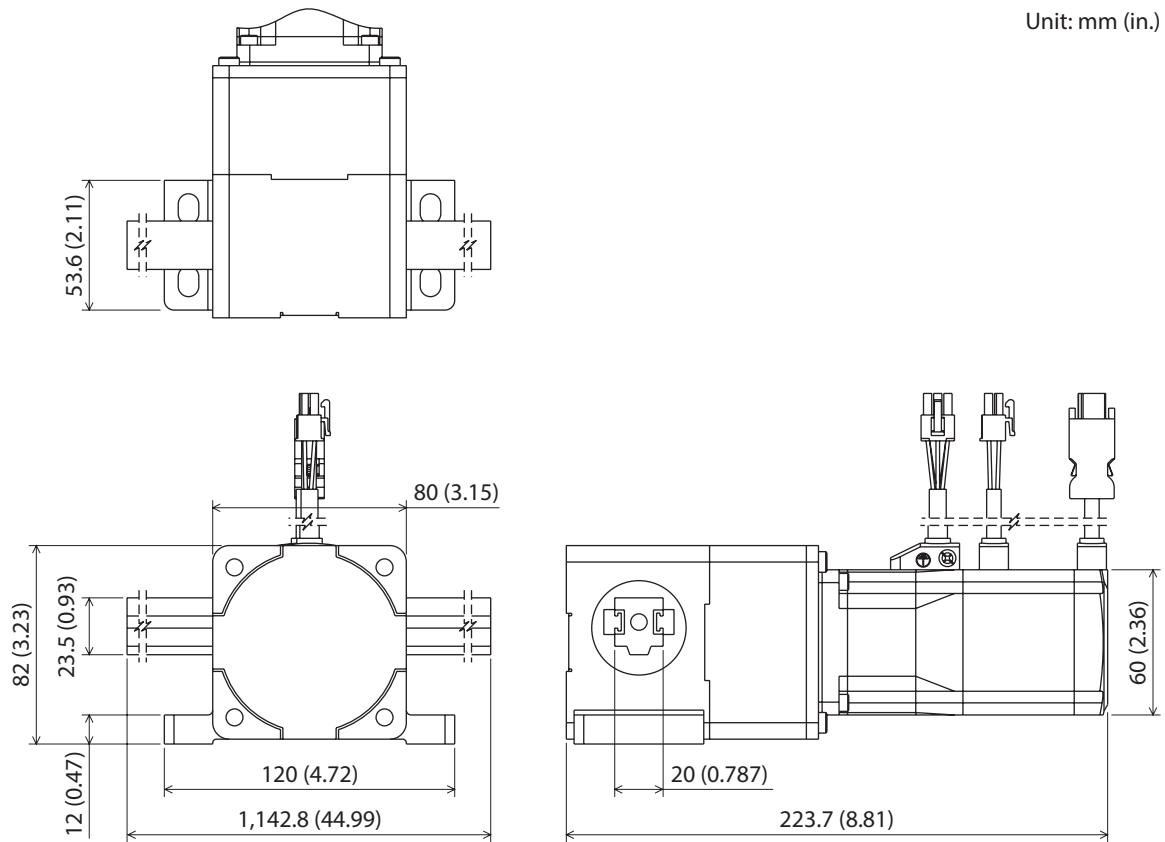

3 Appendix

1-4 LM4 F type

Example: **LM4F40AZMC-10**
 Mass: 5.9 kg (13.0 lb.)

Unit: mm (in.)

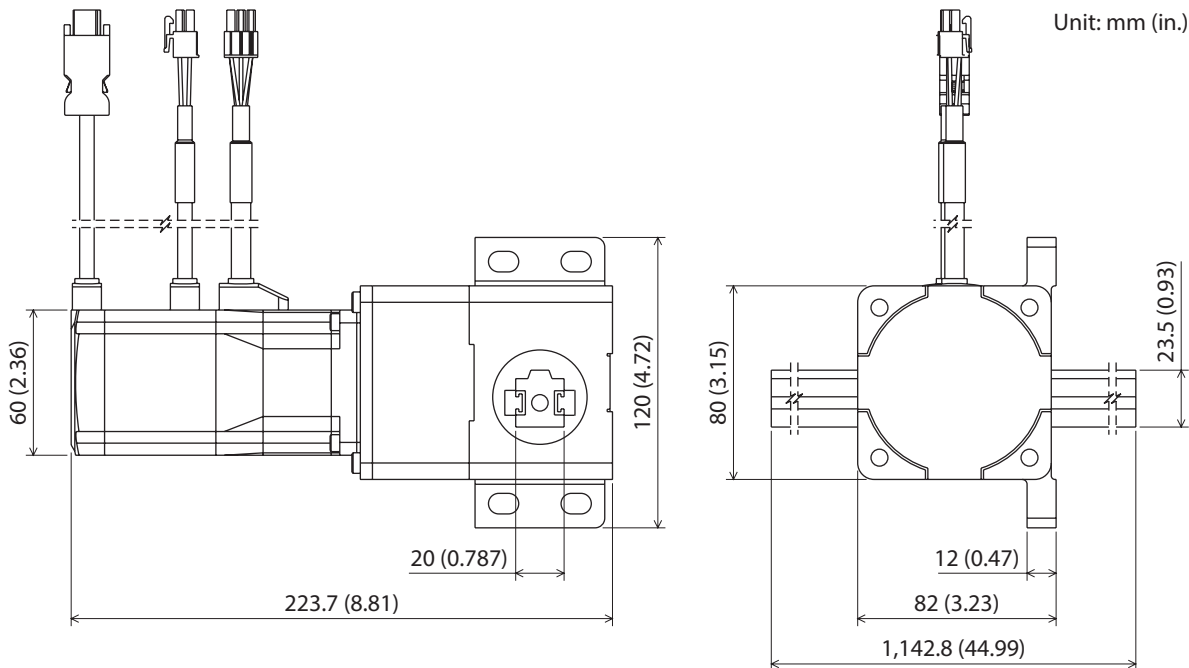

- Unauthorized reproduction or copying of all or part of this Operating Manual is prohibited.
If a new copy is required to replace an original manual that has been damaged or lost, please contact your nearest Oriental Motor sales office.
- Oriental Motor shall not be liable whatsoever for any problems relating to industrial property rights arising from use of any information, circuit, equipment or device provided or referenced in this manual.
- Characteristics, specifications and dimensions are subject to change without notice.
- While we make every effort to offer accurate information in the manual, we welcome your input. Should you find unclear descriptions, errors or omissions, please contact your nearest Oriental Motor sales office.
- **Orientalmotor**, **αSTEP** and ABZO sensor are registered trademarks or trademarks of Oriental Motor Co., Ltd., in Japan and other countries.
Other product names and company names mentioned in this manual may be registered trademarks or trademarks of their respective companies and are hereby acknowledged. The third-party products mentioned in this manual are recommended products, and references to their names shall not be construed as any form of performance guarantee. Oriental Motor is not liable whatsoever for the performance of these third-party products.

© Copyright ORIENTAL MOTOR CO., LTD. 2019

Published in March 2023

- Please contact your nearest Oriental Motor office for further information.

ORIENTAL MOTOR U.S.A. CORP.
Technical Support Tel:800-468-3982
8:30am EST to 5:00pm PST (M-F)
www.orientalmotor.com

ORIENTAL MOTOR (EUROPA) GmbH
Schiesstraße 44, 40549 Düsseldorf, Germany
Technical Support Tel:00 800/22 55 66 22
www.orientalmotor.de

ORIENTAL MOTOR (UK) LTD.
Unit 5 Faraday Office Park, Rankine Road,
Basingstoke, Hampshire RG24 8QB UK
Tel:+44-1256347090
www.oriental-motor.co.uk

ORIENTAL MOTOR (FRANCE) SARL
Tel:+33-1 47 86 97 50
www.orientalmotor.fr

ORIENTAL MOTOR ITALIA s.r.l.
Tel:+39-02-93906347
www.orientalmotor.it

ORIENTAL MOTOR ASIA PACIFIC PTE. LTD.
Singapore
Tel:1800-842-0280
www.orientalmotor.com.sg

ORIENTAL MOTOR (MALAYSIA) SDN. BHD.
Tel:1800-806-161
www.orientalmotor.com.my

ORIENTAL MOTOR (THAILAND) CO., LTD.
Tel:1800-888-881
www.orientalmotor.co.th

ORIENTAL MOTOR (INDIA) PVT. LTD.
Tel:1800-120-1995 (For English)
1800-121-4149 (For Hindi)
www.orientalmotor.co.in

TAIWAN ORIENTAL MOTOR CO., LTD.
Tel:0800-060708
www.orientalmotor.com.tw

SHANGHAI ORIENTAL MOTOR CO., LTD.
Tel:400-820-6516
www.orientalmotor.com.cn

INA ORIENTAL MOTOR CO., LTD.
Korea
Tel:080-777-2042
www.inaom.co.kr

ORIENTAL MOTOR CO., LTD.
4-8-1 Higashiueno, Taito-ku, Tokyo
110-8536 Japan
Tel:+81-3-6744-0361
www.orientalmotor.co.jp