

Brushless Motor

BLH Series

RS-485 communication type

OPERATING MANUAL

Thank you for purchasing an Oriental Motor product.

This Operating Manual describes product handling procedures and safety precautions.

- Please read it thoroughly to ensure safe operation.
- Always keep the manual where it is readily available.

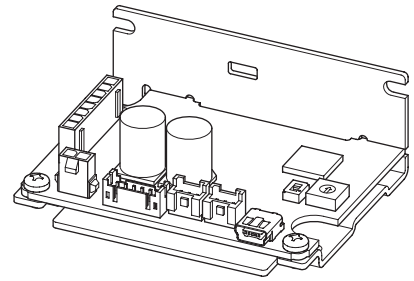

Table of contents

1	Introduction	4	9	Parameter	32
2	Safety precautions	5	9.1	Parameter list	33
3	Precautions for use	6	9.2	Operation data extension setting	37
4	Preparation	7	9.3	Operation and I/O action.....	40
4.1	Checking the product.....	7	9.4	Alarm and information settings.....	44
4.2	How to identify the product model.....	7	9.5	Monitor setting	47
4.3	Information about nameplate	7	9.6	Direct-IN function selection, Direct-OUT function selection.....	48
4.4	Products possible to combine	8	9.7	Remote-IN function selection, Remote-OUT function selection	48
4.5	Names and functions of parts.....	9	9.8	Communication and I/F function	49
5	Installation	10	9.9	I/O signals assignment list.....	56
5.1	Installation location.....	10	10	I/O signals.....	57
5.2	Installing the driver.....	10	10.1	Direct I/O	57
6	Connection	11	10.2	Remote I/O.....	59
6.1	Connecting the motor and driver (CN3)	11	10.3	Signals list.....	61
6.2	Connecting the power supply (CN1).....	12	10.4	Input signals.....	64
6.3	Connecting the I/O signals (CN2)	13	10.5	Output signals	68
6.4	Driver I/O circuit.....	14	10.6	General signals	71
6.5	Connecting external analog setting devices.....	16	11	Modbus RTU control (RS-485 communication)	72
6.6	Grounding.....	17	11.1	Modbus RTU specifications	72
6.7	Connecting the USB cable (CN4)	17	11.2	Message structure.....	75
6.8	Connecting the RS-485 communication cable (CN5, CN6)	18	11.3	Function code.....	79
6.9	Connection diagram	19	11.4	Flow of setting required for Modbus communication.....	85
6.10	Noise elimination measures	20	11.5	Setting of RS-485 communication	86
6.11	Conformity to EMC.....	20	11.6	Data setting method	87
7	Operation data	22	11.7	Group send	92
7.1	Setting the operation data.....	22	11.8	Setting example.....	94
7.2	Setting the rotation speed	23	11.9	Timing charts	98
7.3	Setting the acceleration time and deceleration time	24	11.10	Communication monitor.....	99
7.4	Setting the torque limiting value	25	11.11	Detection of communication errors	100
7.5	Example of operation pattern.....	27			
7.6	Rotation direction of the motor output shaft.....	27			
7.7	Multi-motor control.....	28			
8	Guidance	29			

12	Addresses and codes list.....	102
12.1	Timing for parameter to update	102
12.2	I/O commands.....	103
12.3	Group command	103
12.4	Protect release commands	104
12.5	Maintenance commands.....	104
12.6	Monitor commands.....	105
12.7	Operation data commands.....	114
12.8	Parameter commands	116
12.9	I/O signals assignment list.....	124
13	MEXE02	126
13.1	Starting MEXE02	126
13.2	Monitor	126
13.3	Test operation.....	131
14	Maintenance and inspection	132
14.1	Inspection	132
14.2	Warranty.....	132
14.3	Disposal.....	132
15	Troubleshooting	133
16	Alarms.....	135
16.1	Alarm reset.....	135
16.2	Alarm history.....	136
16.3	Generation condition of alarms	137
16.4	Alarm list.....	137
17	Information.....	139
17.1	Information history.....	139
17.2	Information lists.....	140
17.3	Information codes.....	142
18	Specifications.....	143
18.1	Specifications.....	143
18.2	General specifications.....	144
18.3	Dimensions.....	144
19	Regulations and standards	145
19.1	UL Standards, CSA Standards.....	145
19.2	CE Marking/UKCA Marking	145
19.3	EU RoHS Directive/UK RoHS Regulation ...	145
19.4	Republic of Korea, Radio Waves Act	145

1 Introduction

■ Before using the product

Only qualified personnel of electrical and mechanical engineering should work with the product.

Use the product correctly after thoroughly reading the section "2 Safety precautions." In addition, be sure to observe the contents described in warning, caution, and note in this manual.

The product described in this manual has been designed and manufactured to be incorporated in general industrial equipment. Do not use for any other purpose. For the power supply, use a DC power supply with reinforced insulation on its primary and secondary sides. Oriental Motor Co., Ltd. is not responsible for any damage caused through failure to observe this warning.

■ Operating manuals for the product



Operating manuals for the **BLH** Series RS-485 communication type are listed below.

Operating manuals are not included with the product. Download from Oriental Motor Website Download Page or contact your nearest Oriental Motor sales office.

	Operating manual name	Manual number
Driver	BLH Series RS-485 communication type OPERATING MANUAL (this document)	HP-5113
	BLHM Motor OPERATING MANUAL	HM-5238
Motor	BLHM Electromagnetic Brake Motor OPERATING MANUAL	HM-5258
	DC Power Input Drivers BLM Motor Connector type OPERATING MANUAL	HM-5267

2 Safety precautions

The precautions described below are intended to ensure the safe and correct use of the product, and to prevent the user and other personnel from exposure to the risk of injury. Use the product only after carefully reading and fully understanding these instructions.

 WARNING	Handling the product without observing the instructions that accompany a "WARNING" symbol may result in serious injury or death.
 CAUTION	Handling the product without observing the instructions that accompany a "CAUTION" symbol may result in injury or property damage.
 Note	The items under this heading contain important handling instructions that the user should observe to ensure safe use of the product.



Explanation of graphic symbols





Indicates "prohibited" actions that must not be performed.



Indicates "compulsory" actions that must be performed.

 WARNING	
	<ul style="list-style-type: none"> Do not use the product in explosive or corrosive environments, in the presence of flammable gases, in places subjected to splashing water, or near combustibles. Doing so may result in fire or injury. Do not transport, install, connect or inspect the product while the power is supplied. Always turn off the power before carrying out these operations. Damage to equipment may result. Do not use a motor in vertical drive such as elevating equipment. When the driver protective function is activated, the motor will stop operating. The moving part may fall, leading to injury or damage to equipment. Do not touch the motor or driver when conducting the insulation resistance measurement or dielectric strength test. Accidental contact may result in electric shock. Do not disassemble or modify the driver. Doing so may cause injury or damage to equipment. Refer all such internal inspections and repairs to the branch or sales office from which you purchased the product.
	<ul style="list-style-type: none"> Only qualified and educated personnel should be allowed to perform installation, connection, operation and inspection/troubleshooting of the product. Handling by unqualified and uneducated personnel may result in fire, injury or damage to equipment. Use a motor and driver only in the specified combination. Failure to do so may result in fire or damage to equipment. If the driver protective function was activated, remove the cause before resetting the protective function. Continuing the operation without removing the cause of the problem may cause malfunction of the motor, leading to injury or damage to equipment. Install the driver in an enclosure. Failure to do so may result in injury. Always keep the power supply voltage of the driver within the specified range. Failure to do so may result in fire. Connect the cables securely according to the wiring example. Failure to do so may result in fire or damage to equipment. Be sure to observe the specified cable sizes. Failure to do so may result in fire or damage to equipment. For the driver power supply, use a DC power supply with reinforced insulation on its primary and secondary sides. Failure to do so may result in electric shock. If the motor is operated by turning on and off the power supply, turn off the driver power in the event of a power failure. Otherwise, the motor may suddenly start when the power is restored, causing injury or damage to equipment. Always turn off the power before performing maintenance or inspection. Failure to do so may result in electric shock.

 CAUTION	
	<ul style="list-style-type: none"> Do not use the driver beyond the specifications. Doing so may result in fire, injury or damage to equipment. Do not touch the driver during operation or immediately after stopping. The surface is hot, and this may cause a skin burn(s). Keep the area around the driver free of combustible materials. Failure to do so may result in fire or a skin burn(s). Do not leave anything around the driver that would obstruct ventilation. Doing so may result in damage to equipment. Do not shut off the negative side of the power supply. Also, make sure that the wiring for the power supply does not disconnect. This may result in damage to equipment.
	<ul style="list-style-type: none"> Securely install the driver to the mounting plate. Inappropriate installation may cause the driver to detach and fall, resulting in injury or damage to equipment. Be sure to ground the motor and driver to prevent them from being damaged by static electricity. Failure to do so may result in fire or damage to equipment. Pay enough attention to safe operation when starting and stopping the motor by switching ON-OFF of the power supply. Failure to do so may result in injury or damage to equipment. Provide an emergency stop device or emergency stop circuit external to the equipment so that the entire equipment will operate safely in the event of a system failure or malfunction. Failure to do so may result in injury. Immediately when trouble has occurred, stop operation and turn off the driver power. Failure to do so may result in fire, electric shock or injury. Before turning on the power to the driver, make sure to turn all input signals of the driver to OFF. Otherwise, the motor may suddenly start when the power is on, leading to injury or damage to equipment.

3 Precautions for use

This chapter covers limitations and requirements the user should consider when using the product.

Use a driver and motor only in the specified combination.

Refer to "4.4 Products possible to combine" on p.8 for combinations of the driver and motor.

- **Notes for continuous regeneration operation**

When regeneration operation is continuously performed, check the following conditions are satisfied before use.

- Set the value of the "Deceleration mode selection" parameter to "Deceleration stop 3."
- Use a power supply that can sufficiently allow the regenerative power.

Note

Do not perform gravitational operation (vertical drive) because a load may fall.

- **Do not conduct the insulation resistance measurement or the dielectric strength test with the motor and driver connected.**

Conducting the insulation resistance measurement or the dielectric strength test with the motor and driver connected may result in damage to the product.

- **Note on power ON/OFF using a mechanical contact**

When turning on or off the power supply using a mechanical contact (breaker, electromagnetic switch, relay, etc.), do so only the positive side (+) of the power supply using the mechanical contact.

Turning on or off the positive side (+) and the negative side (–) of the power supply simultaneously using a mechanical contact may cause damage to the control circuit or peripheral equipment.

Refer to p.12 for details.

- **Note on connecting a power supply whose positive terminal is grounded**

The driver's USB connector is not electrically insulated. When grounding the positive terminal of the power supply, do not connect any equipment (PC, etc.) whose negative terminal is grounded. Doing so may cause the driver and these equipment to short, damaging both.

- **Noise elimination measures**

Refer to p.20 for the noise elimination measures.

- **Notes when saving the data to the non-volatile memory**

Do not turn off the power supply while writing the data to the non-volatile memory, and also do not turn off for 5 seconds after the completion of writing the data. Doing so may abort writing the data and cause an EEPROM error alarm to generate.

The non-volatile memory can be rewritten approximately 100,000 times.

- **Grease measures**

On rare occasions, grease may ooze out from the gearhead. If there is concern over possible environmental contamination resulting from the leakage of grease, check for grease stains during regular inspections. Alternatively, install an oil pan or other device to prevent damage resulting from contamination. Grease leakage may lead to problems in the user's equipment or products.

- **Apply grease to the hollow output shaft of a hollow shaft flat gearhead.**

Apply grease (molybdenum disulfide grease, etc.) on the surface of the load shaft and the inner walls of the hollow output shaft to prevent seizure.

- **Sliding noise of electromagnetic brake**

Sliding noise of the brake disk for the electromagnetic brake motor may be generated during operation.

It is no functional problem.

4 Preparation

This chapter explains the items you should check, as well as the name and function of each part.

4.1 Checking the product

Verify that the items listed below are included.

Report any missing or damaged items to the branch or sales office from which you purchased the product.

Refer to "4.4 Products possible to combine" for combinations of the driver and motor.

Driver 1 unit

Instructions and Precautions for Safe Use.....1 copy

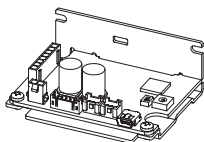

4.2 How to identify the product model

BLH2D 30 D H - K R

① ② ③ ④ ⑤ ⑥

①	Driver type	BLH2D: BLH Series driver
②	Output power	15: 15 W 30: 30 W 50: 50 W
③	Identification code	D
④	Motor connection method	Blank: Cable type H : Connector type
⑤	Power supply voltage	K: 24 VDC
⑥	R: RS-485 communication type D: Digital setting type Blank: Analog setting type	

4.3 Information about nameplate

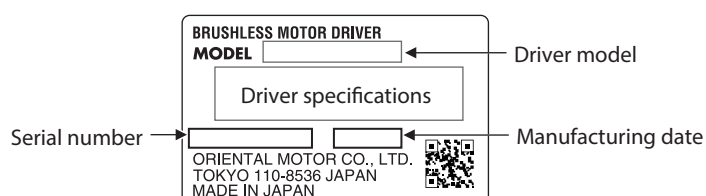

4.4 Products possible to combine

Products with which the drivers can be combined are listed below.

Verify the driver model and the motor model against the model name described on the nameplate of the product.

Motor model columns in the table below describes part of the motor model name.

For details about the motor, refer to the operating manual of the motor.

Applicable motor	Output power	Driver model	Motor model	Cable set model
BLHM Motor	15 W	BLH2D15-KR	BLHM015	LHS003CC or LHS010CC
	30 W	BLH2D30-KR	BLHM230	
	50 W	BLH2D50-KR	BLHM450	
BLM Motor	15 W	BLH2D15H-KR	BLM015HK	
	30 W	BLH2D30DH-KR	BLM030DHK	
		BLH2D30H-KR	BLM230HK	
	50 W	BLH2D50DH-KR	BLM250DHK	
		BLH2D50H-KR	BLM450HK	

● **Cable set** (Each cable can be purchased separately.)

- I/O signal cable 1 pc
- Power supply cable 1 pc



Length	Cable set model	I/O signal cable	Power supply cable
300 mm (11.8 in.)	LHS003CC	LH003C3	LH003C1
1000 mm (39.4 in.)	LHS010CC	LH010C3	LH010C1

4.5 Names and functions of parts

This section explains the name and function for each part of the driver.

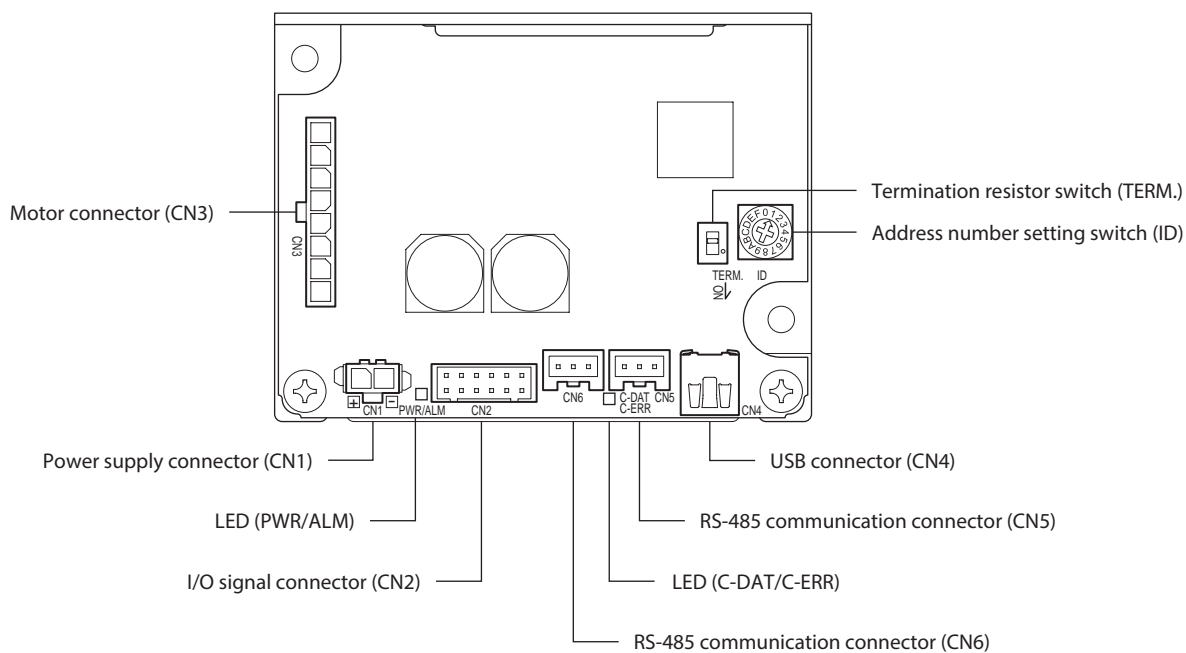

Name	Sign	Description
Power supply connector	CN1	Connects the power supply cable.
I/O signal connector	CN2	Connects the I/O signal cable to connect with an external control device.
Motor connector	CN3	Connects the motor cable.
USB connector	CN4	Connects a PC in which the MEXE02 has been installed.
RS-485 communication connector	CN5	Connects a communication cable to connect with an external control device.
	CN6	Or connect to a different driver with a daisy chain.
LED	PWR/ALM	This LED is lit in green while the power is supplied. If an alarm is generated, this LED will blink in red. If information is generated, it will blink in orange.
	C-DAT C-ERR	This LED is lit in green when the driver communicates with the master station properly via RS-485 communication. This LED is lit in red when an error occurs in communication with the master station via RS-485 communication.
Address number setting switch	ID	Sets the address number when used via RS-485 communication. Factory setting: 1 (0 to F)
Termination resistor switch	TERM.	Sets the termination resistor (120 Ω) of RS-485 communication. Factory setting: OFF (OFF: Disabled, ON: Enabled)

5 Installation

5.1 Installation location

The driver is designed and manufactured to be incorporated in equipment.

Install it in a well-ventilated location that provides easy access for inspection. The location must also satisfy the following conditions:

- Inside an enclosure that is installed indoors (provide vent holes)
- Operating ambient temperature: 0 to +50°C [+32 to 122 °F] (non-freezing)
- Operating ambient humidity: 85% or less (non-condensing)
- Area that is free of explosive atmosphere or toxic gas (such as sulfuric gas) or liquid
- Area not exposed to direct sun
- Area free of excessive amount of dust, iron particles or the like
- Area free of excessive salt
- Area not subject to splashing water (rain, water droplets), oil (oil droplets) or other liquids
- Area not subject to continuous vibration or excessive shocks
- Area free of excessive electromagnetic noise (from welders, power machinery, etc.)
- Area free of radioactive materials, magnetic fields or vacuum
- Altitude Up to 1000 m (3300 ft.) above sea level

5.2 Installing the driver

■ Installation direction

The driver is designed on the basis of heat radiation by air convection and heat conduction to an enclosure.

When installing the driver in an enclosure, be sure to use the mounting holes on the driver, and install it in a vertical direction or horizontal direction.

● Vertical installation

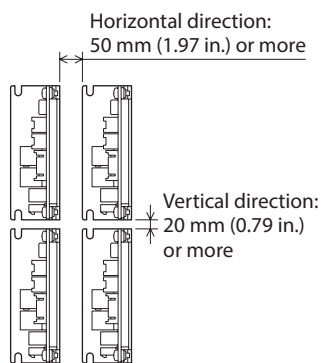

● Horizontal installation

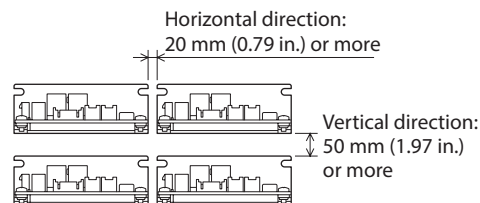

- Drivers can be installed as shown in the figure below. When using the USB cable for communication, install them with taking the cable outlet position into account.

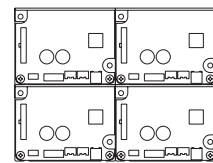

Both the vertical installation and the horizontal installation are available.

■ Installation method

Install the driver onto an appropriate flat metal plate having excellent vibration resistance and heat conductivity.

Using the mounting holes or notches of the driver, secure it with two screws (M3: not included) so that there is no gap between the driver and metal plate.

Note

- Do not install any equipment that generates a large amount of heat or noise near the driver.
- If the ambient temperature of the driver exceeds the upper limit of the operating ambient temperature, reconsider the ventilation condition or forcibly cool the area around the driver using a fan in order to keep within the operating ambient temperature.

6 Connection

This chapter explains how to connect the driver with the motor, power supply, and I/O signals.

6.1 Connecting the motor and driver (CN3)

Insert the motor cable connector into the motor connector (CN3) on the driver.

When extending the motor cable, use a connection cable (sold separately).

The maximum extension distance including the cable length of the motor itself should be 5 m (16.4 ft.).



- Firmly insert the connector in position. Insecure connector connection may cause malfunction or damage to the motor or driver.
- Be sure to insert and pull out the connector while holding the connectors part. Do not apply any force in a direction other than the direction of inserting and pulling out the connector. Applying improper force may cause damage to the connector and driver.

CN3 pin assignment

Viewed from the direction of an arrow
in the right figure

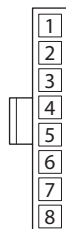

Housing 43645-0800 (molex) or 1445022-8 (TE Connectivity)

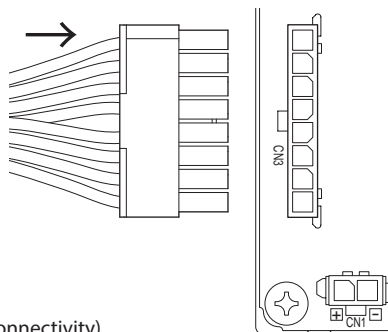

Pin No.	Lead wire color*	Lead wire size
1	Gray (Black)	AWG22
2	Purple	
3	Blue	
4	Yellow	AWG26
5	Green	
6	Orange	
7	Red	
8	Brown (White)	

* The color in parentheses () indicates the 15 W type.

For lead wire type and connector type, all lead wire sizes are AWG22 (**BLHM015**: AWG24).

6.2 Connecting the power supply (CN1)

Insert the power supply cable connector into the power supply connector (CN1) on the driver.
Lead wire size: AWG22 (0.3 mm²)



- When connecting, pay attention to the polarity of the power supply. Connection with incorrect polarity may cause damage to the driver.
- Do not wire the power supply cable of the driver in the same cable duct with other power lines or motor cables.
- When turning on the power again or inserting/pulling out the motor cable connector, turn off the power and wait for at least 5 seconds before doing so.

CN1 pin assignment

Viewed from the direction of an arrow in the right figure

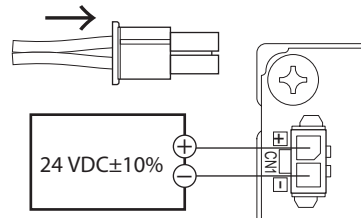

Housing: 43645-0200 (molex) or 1445022-2 (TE Connectivity)

Pin No.	Lead wire color	Lead wire size
1	Red	AWG22
2	Black	

Note on power ON/OFF using a mechanical contact

- When turning on or off the power supply using a mechanical contact (breaker, electromagnetic switch, relay, etc.), do so only the positive side (+) of the power supply using the mechanical contact.

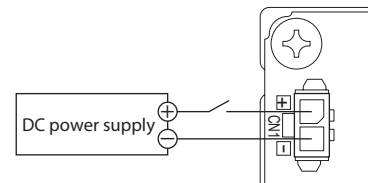

Do not turn on or off the positive side (+) and the negative side (-) of the power supply simultaneously or shut off only the negative side (-) of the power supply.

The main circuit and the control circuit in the driver are connected to the same ground. So the input current of the main circuit flows round into the control circuit when the power supply is turned on or off, causing damage to the control circuit or peripheral equipment.

6.3 Connecting the I/O signals (CN2)

Insert the connector of the I/O signal cable into the I/O signal connector (CN2) on the driver.
Lead wire size: AWG26 (0.14 mm²)

CN2 pin assignment

Viewed from the direction of an arrow in the right figure

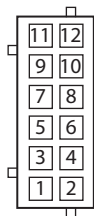

Housing: PHDR-12VS (JST)

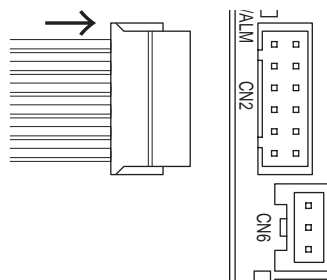

Pin No.	Lead wire color	Terminal name	Initial assignment signal*1	Description
12	–	–	–	Not connected.
11	Black	D-IN0	START/STOP	These signals are used to operate the motor. The motor rotates according to the acceleration time when both the START/STOP input and RUN/BRAKE input are turned ON. If the START/STOP input is turned OFF, the motor stops according to the deceleration time. If the RUN/BRAKE input is turned OFF, the motor stops instantaneously.
10	White	D-IN1	RUN/BRAKE	
9	Gray	D-IN2	FWD/REV	This signal is used to change the motor rotation direction. The motor rotates in the forward direction when the signal is turned ON. *2
8	Light blue	D-IN3	M0	This signal is used to select the operation data number.
7	Purple	D-IN4	ALM-RST	This signal is used to reset the alarm. (The alarm will be reset at the ON edge of the input.)
6	Blue	VH	External analog setting device*3	These signals are used when the rotation speed is externally set using an external analog setting device (external potentiometer or external DC voltage).
5	Green	VM		
4	Yellow	VL		
3	Orange	GND	GND	I/O signals common
2	Red	D-OUT0	SPEED-OUT	30 pulses are output while the motor output shaft makes one revolution.
1	Brown	D-OUT1	ALM-B	This is a signal to output an alarm status. It is turned OFF when an alarm is generated. (Normally closed)

- *1 These signals are assigned at the time of shipment. Functions for the pin Nos. 1, 2, and 7 to 11 can be changed using the **MEXE02** or RS-485 communication.
- *2 The rotation direction of the output shaft varies depending on the gear ratio of the gearhead. The rotation direction can be changed by setting of the "Motor rotation direction" parameter.
- *3 If the "External setting method" parameter is changed, the rotation speed and torque limiting value can be set with the PWM signal input.

6.4 Driver I/O circuit

■ Input signals circuit

Input signals of the driver are C-MOS inputs.

The signal state represents "ON: 0 to 0.5 V (L level)" and "OFF: 4 to 5 V (H level)."

- External control device output is a 5 V C-MOS output

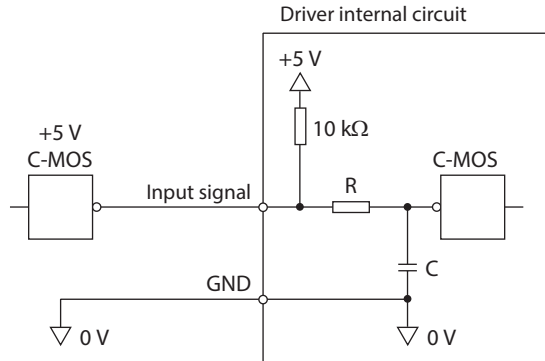

- External control device output is an open-collector output

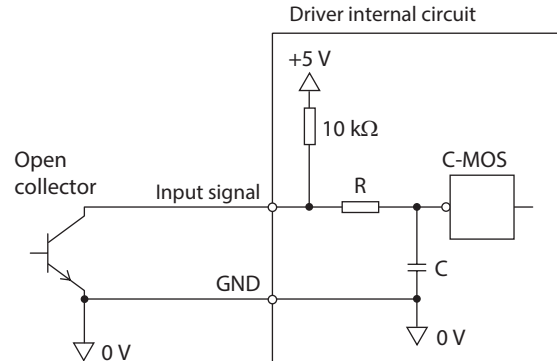

- Switch connection

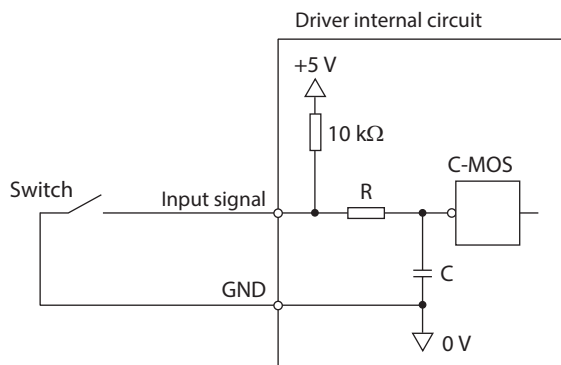

- Changing the logic level setting of input signals

The logic level setting for input terminals D-IN0 to D-IN4 can be changed using the **MEXE02** or RS-485 communication. Refer to p.58 for details.

■ Output signals circuit

Output signals of the driver are transistor open-collector outputs. The signal state represents a state of "ON: Carrying current" or "OFF: Not carrying current" for the internal transistor rather than the voltage level of the signal.

ON voltage: 0.5 VDC maximum

External power supply: 4.5 to 26.4 VDC, 10 mA or less

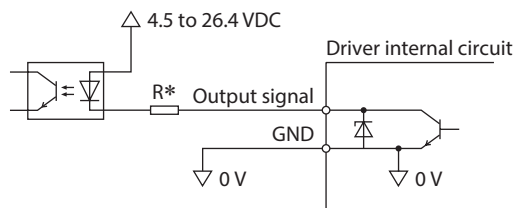

* Recommended resistance value when a current limiting resistor R is connected:

For 24 VDC: 2.7 k Ω to 4.7 k Ω (1 W)

For 5 VDC: 560 Ω to 820 Ω (0.25 W)

● Changing the logic level setting of output signals

The logic level setting for output terminals D-OUT0 and D-OUT1 can be changed using the **MEXE02** or RS-485 communication.

However, if the SPEED-OUT output is assigned, it cannot be changed.

Refer to p.58 for details.

Note

- For output signals, be sure to connect a current-limiting resistor R so that the current does not exceed 10 mA. When using a programmable controller, check the resistance value inside the controller and connect a current-limiting resistor R as necessary.
- When a relay (inductive load) is connected, provide a control measure for the fly-back voltage against the relay by connecting a diode. Or use a relay with built-in flywheel diode.

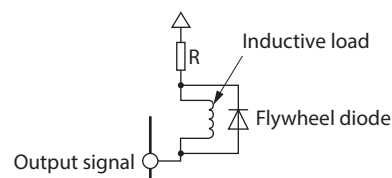

■ Timing chart when power is input

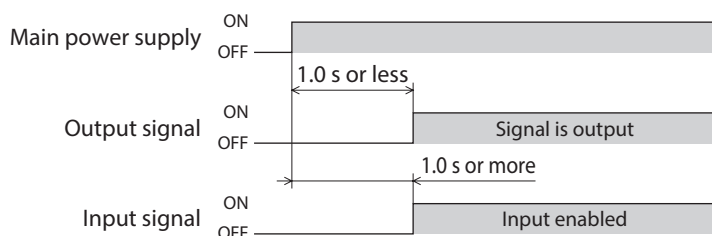

6.5 Connecting external analog setting devices

Using an external potentiometer (sold separately), external DC voltage, or PWM signal input, the rotation speed or the torque limiting value can be set.

■ Using an external potentiometer

Connect to the pin Nos. 4 to 6 of the CN2.

memo When the **PAVR2-20K** is used, use the ferrule (rod terminal).
 Manufacturer: PHOENIX CONTACT GmbH & Co. KG
 Model: AI 0,14-8 [AWG26 (0.14mm²)]

Note When a shielded cable is used for connection with the external potentiometer, connect shields to VL of the pin No.4 from near the I/O signal connector (CN2).

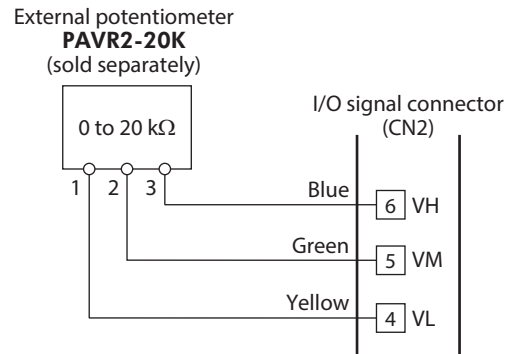

■ Using external DC voltage

For external DC voltage, use a DC power supply (0 to 5 VDC) with reinforced insulation on its primary and secondary sides, and connect to the pin Nos. 4 and 5 of the CN2.

The input impedance between the VM input and the VL input is approximately 47 kΩ.

The VL input is connected to GND inside the driver.

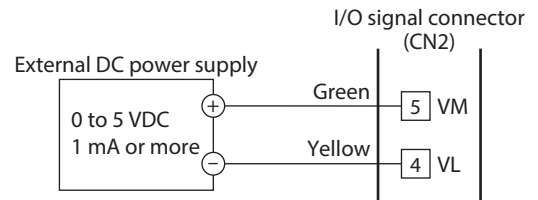

- Note**
- Be sure to use the voltage of an external control device at 5 VDC or lower. When connecting an external control device, make sure the polarities are correct. If the polarities are reversed, the driver may be damaged.
 - When a shielded cable is used for connection with the external control device, connect shields to VL of the pin No.4 from near the I/O signal connector (CN2).

■ Using PWM signal input

When the operation data is set using the PWM signal input, connect the PWM signal lines to the pin Nos. 4 and 5 of the CN2.

- Input signal specifications

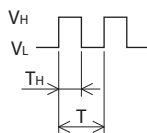

$$\text{PWM duty cycle (\%)} = \frac{T_H}{T} \times 100$$

$$\text{PWM frequency* (kHz)} = \frac{1}{T}$$

$$V_H = 4.5 \text{ to } 5.0 \text{ V} \quad V_L = 0 \text{ to } 0.5 \text{ V}$$

* Available for 1 kHz to 25 kHz

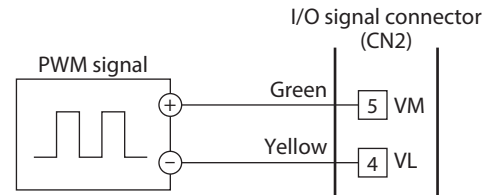

- Note**
- Be sure to use the voltage of an external control device at 5 VDC or lower. When connecting an external control device, make sure the polarities are correct. If the polarities are reversed, the driver may be damaged.
 - When a shielded cable is used for connection with the external control device, connect shields to VL of the pin No.4 from near the I/O signal connector (CN2).

6.6 Grounding

The wire used to ground the motor and driver must be as thick and short to the grounding point as possible so that no potential difference is generated. Choose a large, thick and uniformly conductive surface for the grounding point.

● Grounding the driver

Install the driver to a metal surface that has grounded.

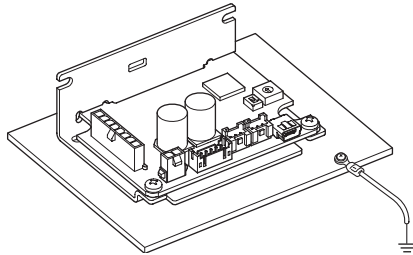

6.7 Connecting the USB cable (CN4)

When the **MEXE02** is used, connect the USB cable to the USB connector.

Specifications of USB cable

Specification	USB2.0 (full speed)
Cable	Length: 3 m (9.8 ft.) or less Shape: A to mini B

Note

- Connect the driver and PC directly with the USB cable without using a hub or extension cable.
- In large electrically noisy environments, use the USB cable with a ferrite core or install a ferrite core to the USB cable.

6.8 Connecting the RS-485 communication cable (CN5, CN6)

Connect this cable when controlling the driver via RS-485 communication.
 Connect the RS-485 communication cable to the CN5 connector or the CN6 connector on the driver. The vacant connector can be used to connect a different driver.
 RS-485 communication cables for connection (sold separately) are available.

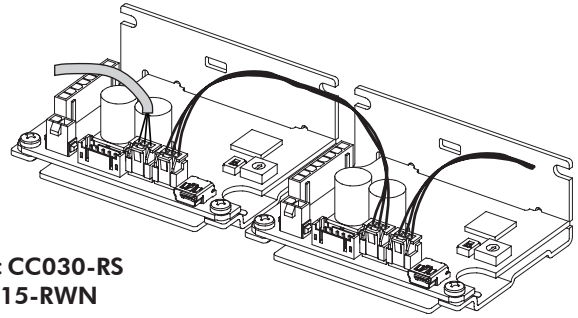

● Model

Cable for connecting between driver and controlle 3 m (9.8 ft.): **CC030-RS**
 Cable for connecting between drivers 150 mm (5.91 in.): **LH0015-RWN**

■ Pin assignments

Pin No.	Signal name	Description	CC030-RS wire color
1	TR+	RS-485 communication signal (+)	White
2	TR-	RS-485 communication signal (-)	Gray
3	GND	GND	Orange

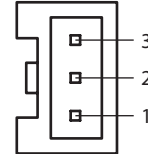

Housing: PAP-03V-S (JST)
 Terminal: SPHD-001T-P0.5 (JST)
 SPHD-002T-P0.5 (JST)

Applicable lead wire

- SPHD-001T-P0.5 AWG26 to 22 (0.13 to 0.33 mm²)
- SPHD-002T-P0.5 AWG28 to 24 (0.08 to 0.21 mm²)

■ Internal input circuit

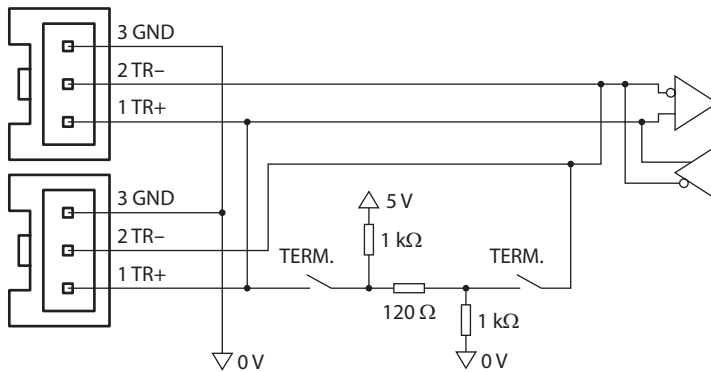

Note

- Keep 10 m (32.8 ft.) or less for the total extension distance of the RS-485 communication cable.
- Use a twisted-pair cable when using a communication cable other than the **CC030-RS**.
- Keep 15 units or less for the number of drivers connected.

6.9 Connection diagram

A connection example of I/O signals with a programmable controller are as shown below.

The I/O signals circuit of the **BLH** Series RS-485 communication type are configured with current SINK logic. (Current SOURCE logic is not supported.)

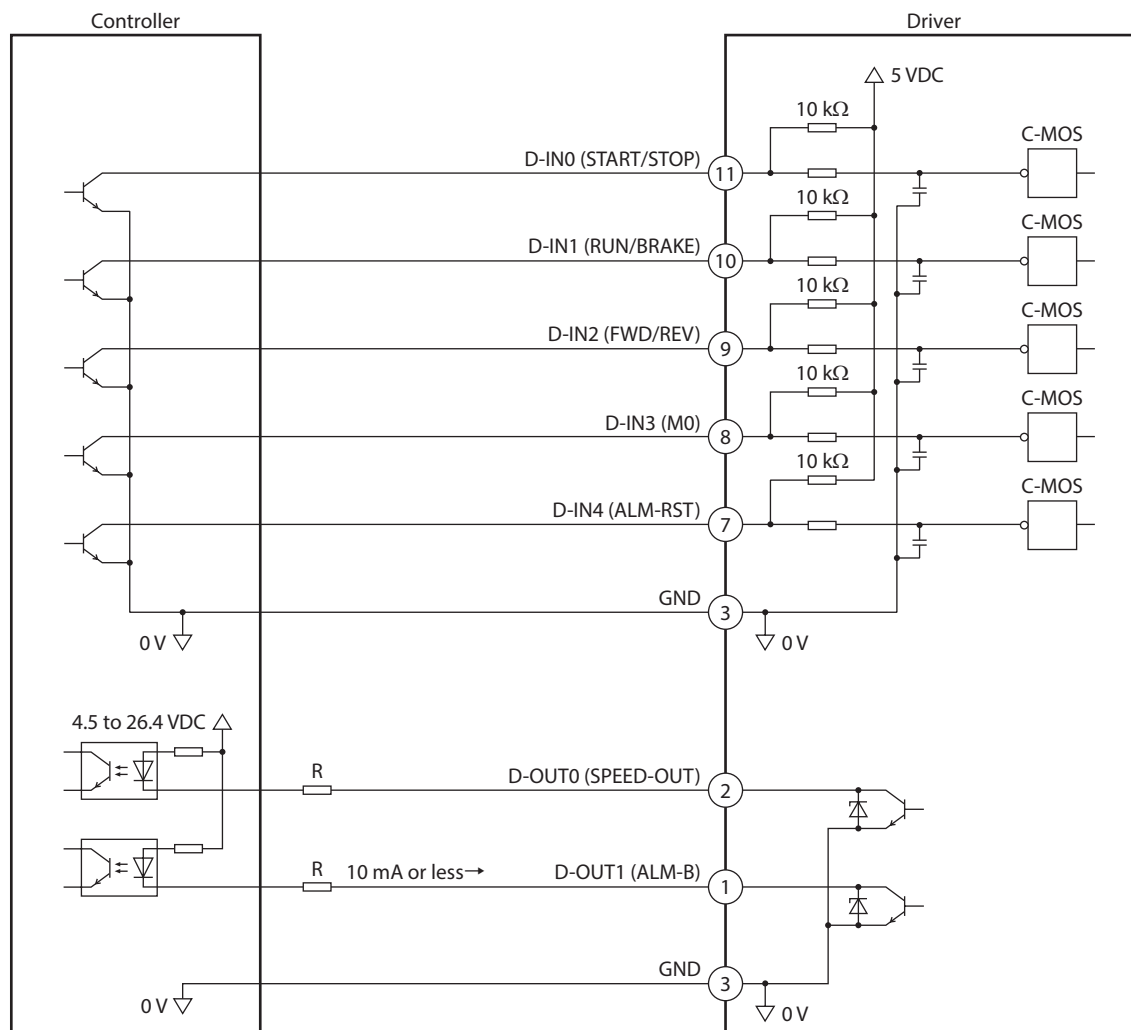

Note

- Insulate unused lead wires which are on the opposite side to the connector of the I/O signal cable to prevent them from contacting other devices, or connect them to 5 VDC or the signal ground (GND) of your external control device according to usage of signals.
- When extending the I/O signal cable, keep the length of 3 m (9.8 ft.) or less and wire in order to suppress noise effects.
- For output signals, be sure to connect a current-limiting resistor R so that the current does not exceed 10 mA. When using a programmable controller, check the resistance value inside the controller and connect a current-limiting resistor R as necessary.

6.10 Noise elimination measures

There are two types of electrical noises: One is a noise to invade into the driver from the outside and cause the driver malfunction, and the other is a noise to emit from the driver and cause peripheral equipments malfunction.

For the noise that is invaded from the outside, take measures to prevent the driver malfunction. It is needed to take adequate measures because signal lines are very likely to be affected by the noise.

For the noise that is emitted from the driver, take measures to suppress it.

Measures against electrical noise

There are the following three methods mainly to take measures against the electrical noise.

● Noise suppression

- When relays or electromagnetic switches are used, use noise filters or CR circuits to suppress surge generated by them.
- Use a connection cable (sold separately) when extending the wiring distance between the motor and the driver. This is effective in suppressing the electrical noise emitted from the motor.
- Cover the driver by a metal plate such as aluminum. This is effective in shielding the electrical noise emitted from the driver.

● Prevention of noise propagation

- Place the power lines such as the motor and power supply cables, keeping a distance of 100 mm (3.94 in.) or more from the signal lines such as I/O signal cable and RS-485 communication cable, and also do not bundle them or wire them in parallel. If a power cable and a signal cable have to cross, cross them at a right angle.
- Use a cable of AWG26 (0.14 mm²) or thicker for the I/O signal cable.
- Use a cable of AWG28 (0.08 mm²) or thicker for the RS-485 communication cable.
- For more effective elimination of noise, use shielded cables for a power supply cable and a signal cable or attach ferrite cores if non-shielded cables are used.
- Keep cables as short as possible without coiling and bundling extra lengths.
- To ground a shielded cable, use a metal cable clamp that can maintain contact with the entire circumference of the shielded cable, and ground as near the product as possible.

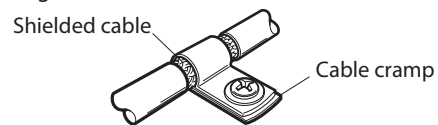

- Grounding multiple points will increase effect to block electrical noise because impedance on the grounding points is decreased. However, ground them so that a potential difference does not occur among the grounding points.

● Suppression of effect by noise propagation

- Loop the noise propagated cable around a ferrite core. Doing so will prevent the propagated noise invades into the driver or emits from the driver. The frequency band in which an effect by the ferrite core can be seen is generally 1 MHz or more. Check the frequency characteristics of the ferrite core used. When increasing the effect of noise attenuation by the ferrite core, loop the cable a lot.

6.11 Conformity to EMC

Effective measures must be taken against the EMI that the motor and driver may give to adjacent control-system equipment, as well as the EMS of the motor and driver itself, in order to prevent a serious functional impediment in the machinery. The use of the following installation and wiring methods will enable the motor and driver to be compliant with EMC. Refer to p.145 for the applicable standards.

Oriental Motor conducts EMC measurements on its motors and drivers in accordance with "Example of installation and wiring" shown on the next page.

The user is responsible for ensuring the machine's compliance with EMC, based on the installation and wiring explained below.

⚠ CAUTION

This equipment is not intended for use in residential environments nor for use on a low-voltage public network supplied in residential premises, and it may not provide adequate protection to radio reception interference in such environments.

■ About power supply

The BLH Series is a product of DC power supply input. Use a DC power supply (such as a switching power supply) that optimally conforms to EMC.

■ Connecting the motor cable

When extending the motor cable, use a connection cable (sold separately). The maximum extension distance including the cable length of the motor itself should be 5 m (16.4 ft.).

■ Notes about installation and wiring

- Connect the motor, driver and other peripheral control equipment directly to the grounding point so as to prevent a potential difference from developing between grounds.
- When relays or electromagnetic switches are used together with the system, use noise filters and CR circuits to suppress surges generated by them.
- Keep a power supply cable and a signal cable as short as possible without coiling and bundling extra lengths.
- Separate power lines such as the motor cable and the power supply cable from signal lines, and wire them apart as much as possible [example: about 100 to 200 mm (3.94 to 7.87 in.)]. If the power lines must cross over the signal lines, wire them at right angles.

■ Example of installation and wiring

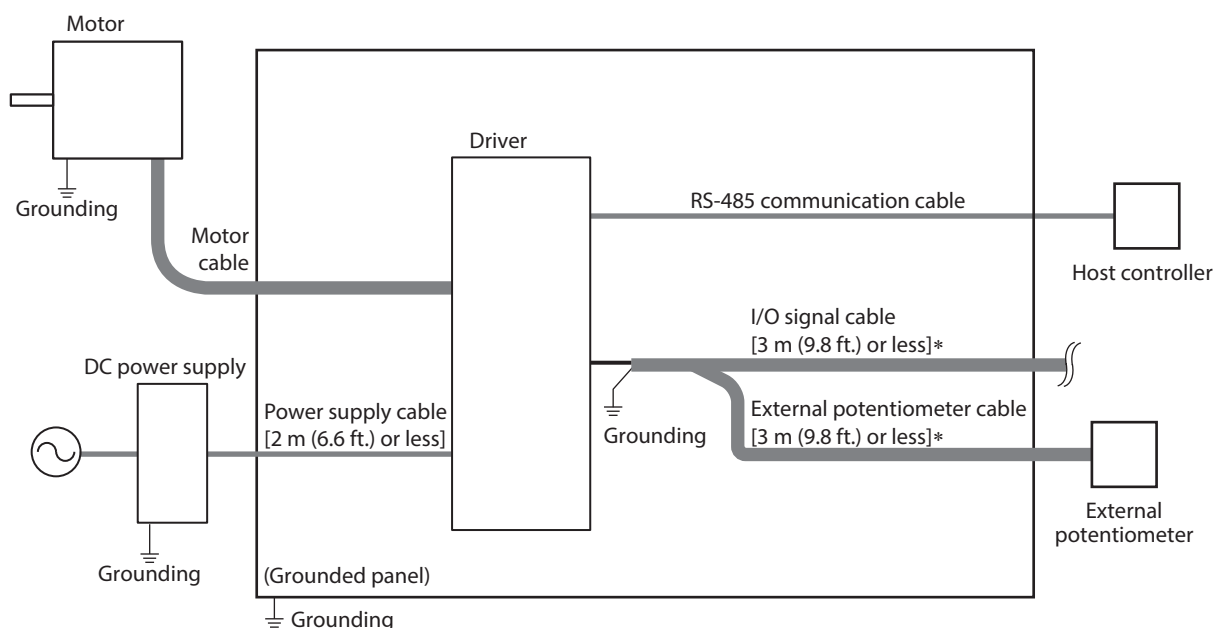

* Shielded cable

■ Precautions about static electricity

Static electricity may cause the driver to malfunction or suffer damage. Be careful of handling the driver while the power is supplied.

Note

- Do not approach or touch the driver while the power is supplied.
- Always use an insulated screwdriver to set the address number setting switch and the termination resistor switch of the driver.

7 Operation data

This chapter describes operations that can be performed with the **BLH** Series RS-485 communication type.

7.1 Setting the operation data

Data required to operate the motor is as follows.

Data name	Description
Rotation speed	The motor rotation speed can be set.
Torque limiting value	The output torque of the motor can be limited. The maximum torque can be set based on the motor rated torque being 100%.
Acceleration time	The acceleration time can be set as a time needed for the motor to reach the reference speed (3000 r/min) from a standstill state.
Deceleration time	The deceleration time can be set as a time needed for the motor to stop from the reference speed (3000 r/min).

Setting method

The setting method of the rotation speed and the torque limiting value is "Digital setting" at the factory setting and can be selected in each operation data number. Eight operation data can be set.

The setting method of operation data can be set using the **MEXE02** or RS-485 communication.

B: Update after operation stop

Parameter name	Description	Setting method	Factory setting	Update
Operation data No.0 rotation speed setting method to Operation data No.7 rotation speed setting method	Selects the setting method of the rotation speed.	0: Digital setting 3: External analog setting device/PWM signal input	0	B
Operation data No.0 torque limiting value setting method to Operation data No.7 torque limiting value setting method	Selects the setting method of the torque limiting value.			



- If "External analog setting device/PWM signal input" of the setting method is selected in both the rotation speed and the torque limiting value of the same operation data number, operation can not be performed. Under this condition, the operation data setting error information is generated. Also, if the operation data number that is the cause of the operation data setting error information is selected to operate, the operation will not be performed and the operation prohibited information will be generated.
- Set the operation data using either the external analog potentiometer or the PWM signal input because the same terminal is used. When the PWM signal input is used, change the "External setting method" parameter to "PWM signal input." (Factory setting: External analog setting device)

Setting range

The setting range and the factory setting of operation data required to operate the motor are as follows.

A: Update immediately



Parameter name	Description	Setting range	Factory setting	Update
Operation data No.0 rotation speed to Operation data No.7 rotation speed	Sets the rotation speed for the operation data Nos. 0 to 7. When the setting method is "Digital setting," the setting value is applied.	0, 80 to 3150 r/min	0	A
Operation data No.0 torque limiting value to Operation data No.7 torque limiting value	Sets the torque limiting value for the operation data Nos. 0 to 7. When the setting method is "Digital setting," the setting value is applied.	0 to 200%	200	
Operation data No.0 acceleration time to Operation data No.7 acceleration time	Sets the acceleration time for the operation data Nos. 0 to 7.	0.1 to 15.0 s	0.5	
Operation data No.0 deceleration time to Operation data No.7 deceleration time	Sets the deceleration time for the operation data Nos. 0 to 7.	0.1 to 15.0 s	0.5	



- The rotation speed and the torque limiting value are applied when the setting method is set to "Digital setting." The setting method can be checked using the status monitor of the **MEXE02** or RS-485 communication.
- 0 r/min is excluded from the "Speed lower limit" parameter.

7.2 Setting the rotation speed

Setting method

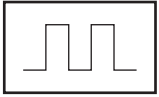
Digital		External analog setting device/PWM signal input		
	Host controller		0 to 5 VDC 1 mA or more	
MEXE02 or RS-485 communication		External potentiometer	External DC voltage	PWM signal

The setting method for each operation data number can be changed using the **MEXE02** or RS-485 communication. If the external analog setting device/PWM signal input is selected in the setting method, set whether to set the operation data with the external analog setting device (external potentiometer, external DC voltage) or the PWM signal input using the "External setting method" parameter. Refer to p.37 when setting the upper limit and the lower limit of the rotation speed.

■ Digital setting

Setting range: 0, 80 to 3150 r/min
(Factory setting: 0 r/min)

■ Using an external potentiometer

An external potentiometer is used to set the speed. Use the **PAVR2-20K** (sold separately) for an external potentiometer. Setting range: 0, 80 to 3150 r/min

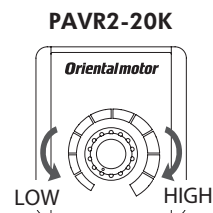

External potentiometer
PAVR2-20K
(sold separately)

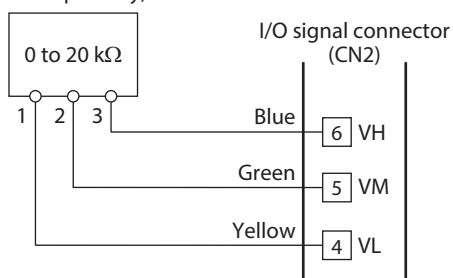

External potentiometer -
Rotation speed characteristics
(representative values)

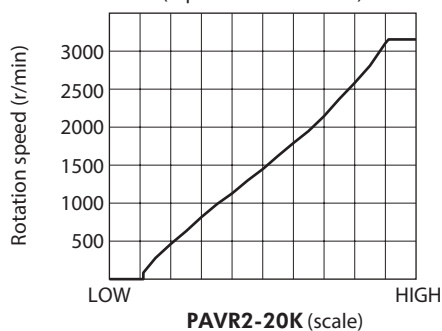

■ Using external DC voltage

External DC voltage is used when the speed is set from an external control device.

For the external DC voltage, use a DC power supply (0 to 5 VDC, 1 mA or more) with reinforced insulation on its primary and secondary sides.

Setting range: 0, 80 to 3150 r/min

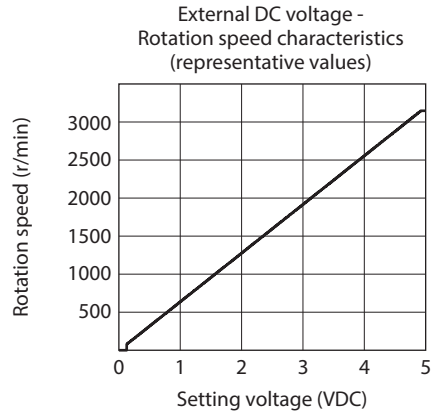
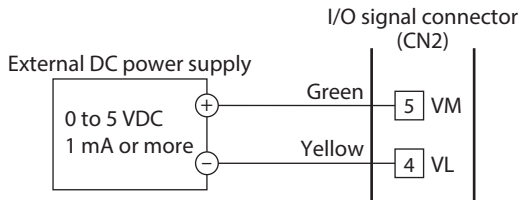

■ Using PWM signal input

The rotation speed is set by inputting the PWM signal.

The rotation speed varies according to the duty cycle of input PWM signals.

Setting range: 0, 80 to 3150 r/min

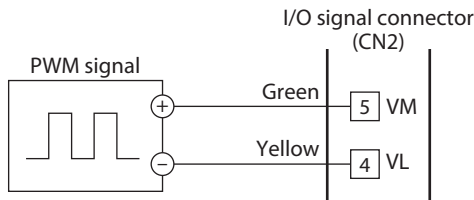

• Input signal specifications

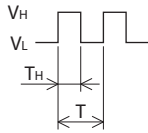

$$\text{PWM duty cycle (\%)} = \frac{T_H}{T} \times 100$$

$$\text{PWM frequency* (kHz)} = \frac{1}{T}$$

$$V_H = 4.5 \text{ to } 5.0 \text{ V} \quad V_L = 0 \text{ to } 0.5 \text{ V}$$

* Available for 1 kHz to 25 kHz

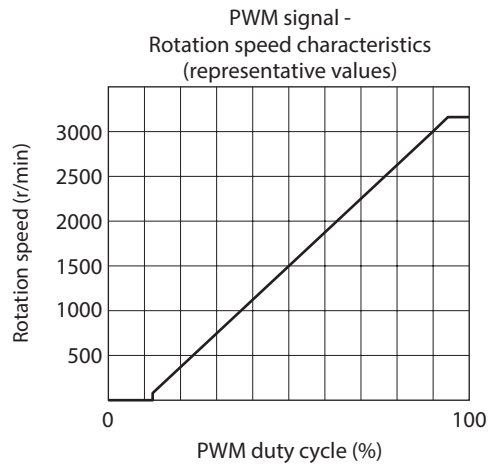

7.3 Setting the acceleration time and deceleration time

The acceleration time and the deceleration time can be set so that an impact is not applied to a load when the motor is started or stopped.

The actual acceleration time and deceleration time vary depending on the conditions of use, load inertia, or load torque specified by the customer.

The acceleration time refers to a time needed for the motor to reach 3000 r/min from a standstill state.

The deceleration time refers to a time needed for the motor to stop from the 3000 r/min.

Setting method

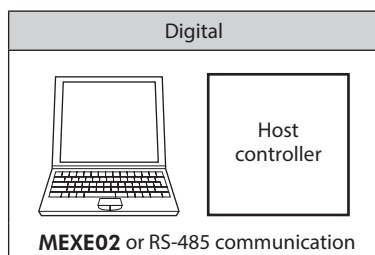

Setting range: 0.1 to 15.0 s
(Factory setting: 0.5 s)

7.4 Setting the torque limiting value

The maximum output torque of the motor can be limited.
Set when limiting the motor output torque according to a load.

■ TL input

When the TL input is assigned to the input terminal, enabling or disabling the torque limiting function can be switched by the ON-OFF status of the TL input.

TL input	Torque limiting	Maximum output torque of motor
ON	Enable	The motor output torque is limited based on the set torque limiting value.
OFF	Disable	The motor output torque is the peak torque.



Note When the TL input is not assigned to the input terminal, this input will be always set to ON. If the TL input is assigned to multiple input terminals, the function will be performed when all of the terminals are turned ON.

■ TLC output

When the motor output torque is limited, the TLC output is turned ON.

Note If the motor is operated at low speed or the torque limiting value is set to less than 20%, the TLC output may not be stable.

Setting method

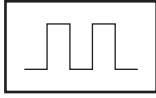
Digital		External analog setting device/PWM signal input		
	Host controller		0 to 5 VDC 1 mA or more	
MEXE02 or RS-485 communication		External potentiometer	External DC voltage	PWM signal

The setting method for each operation data number can be changed using the **MEXE02** or RS-485 communication. If the external analog setting device/PWM signal input is selected in the setting method, set whether to set the operation data with the external analog setting device (external potentiometer, external DC voltage) or the PWM signal input using the "External setting method" parameter. Refer to p.38 when setting the upper limit of the torque limiting value.

■ Digital setting

Setting range: 0 to 200%
(Factory setting: 200%)

■ Using an external potentiometer

When the torque limiting value is set using an external potentiometer, use the **PAVR2-20K** (sold separately).
Setting range: 0 to 200%

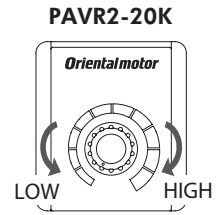

External potentiometer
PAVR2-20K
(sold separately)

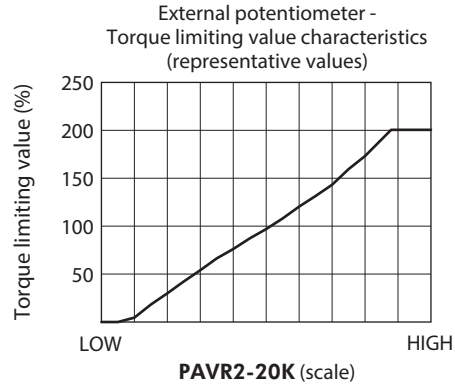
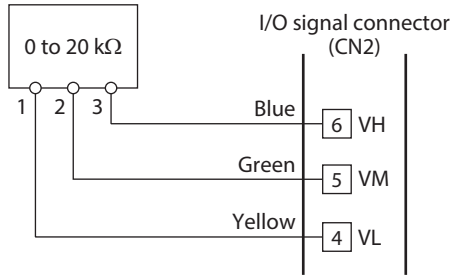

■ Using external DC voltage

Use when the torque limiting value is set by DC voltage from an external control device. For the external DC voltage, use a DC power supply (0 to 5 VDC, 1 mA or more) with reinforced insulation on its primary and secondary sides.
Setting range: 0 to 200%

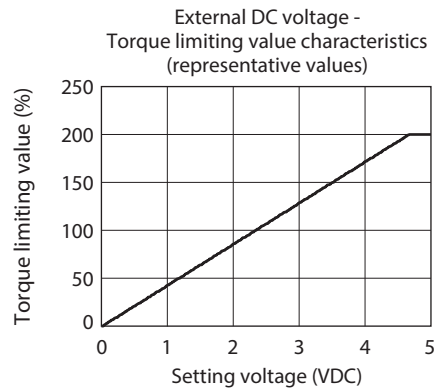
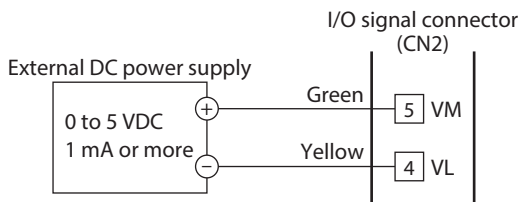

■ Using PWM signal input

Set the torque limiting value by inputting the PWM signal.
The torque limiting value changes according to the duty cycle of input PWM signal.
Setting range: 0 to 200%

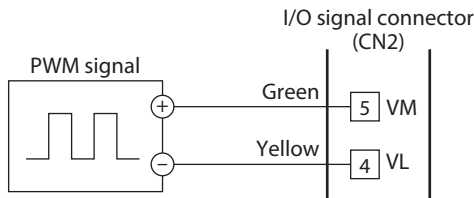

• Input signal specifications

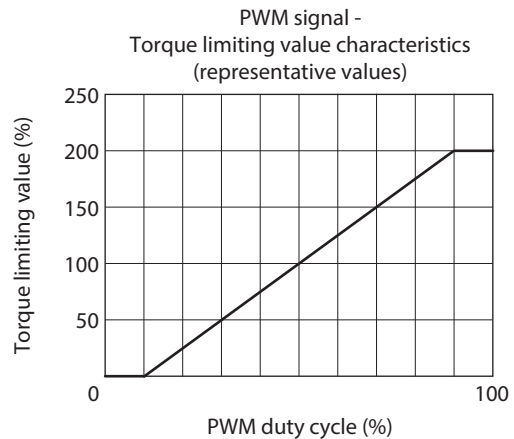
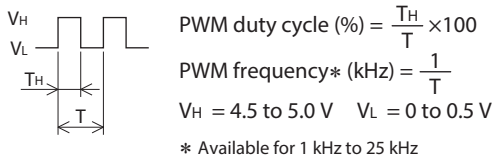

7.5 Example of operation pattern

The figure shows an example when operation is performed using direct I/O after setting 2000 r/min to the operation data No.0 and 650 r/min to the operating data No.1 in the 3-wire mode.

The rotation direction shows the round shaft type. It varies depending on the gear ratio of gearhead.

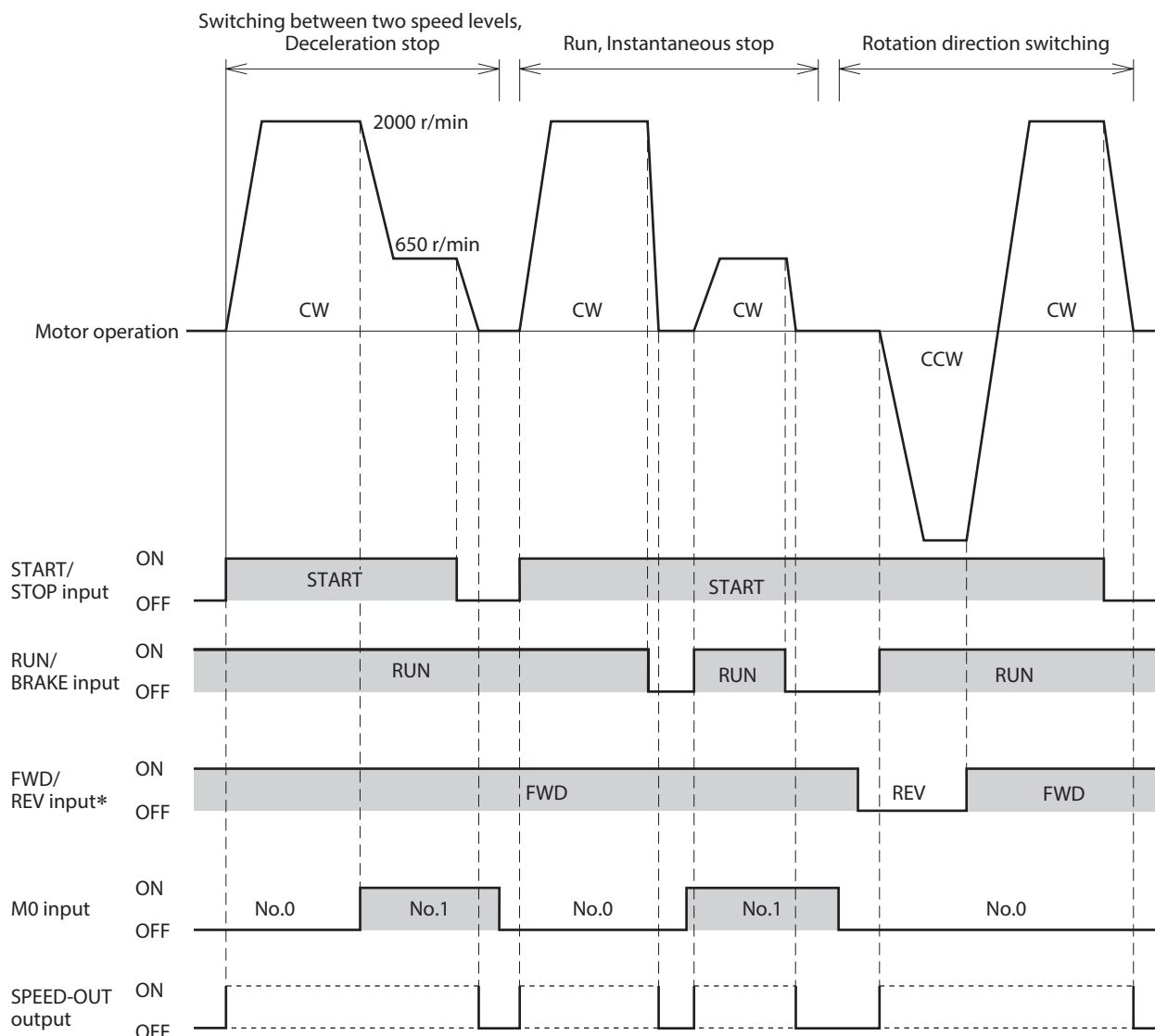

* The motor rotation direction when the FWD/REV input is turned ON can be changed by setting of the "Motor rotation direction" parameter. Refer to p.42 for details.



To surely recognize the input signal, ensure the ON time and OFF time of each input signal for at least 2 ms.

7.6 Rotation direction of the motor output shaft

The rotation direction of the motor output shaft represents the direction when viewed from the motor output shaft.

The motor rotation direction can be changed using the **MEXE02** or RS-485 communication.

The figure shows when the "Motor rotation direction" parameter is set to "+=CW." "Motor rotation direction" parameter ⇒ p.42

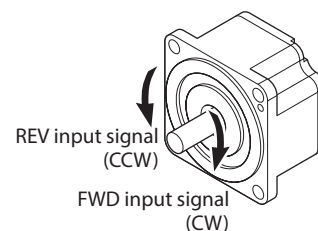

Rotation direction of the gearhead output shaft

The rotation direction of the gearhead output shaft varies depending on the type or the gear ratio of the gearhead. Check the operating manual of the motor for the rotation direction of the gearhead output shaft.

7.7 Multi-motor control

Operating two or more motors at the same speed can be performed using an external potentiometer or external DC voltage.

Using an external potentiometer

Use common lines for the power supply and speed setting, and set the speed using VRx as shown in the figure below.

- Obtain the resistance value for the external speed potentiometer as follows.

Resistance VRx when the number of drivers is n units: $VRx (k\Omega) = 20 k\Omega/n$, permissible dissipation (W) = $n/20$

Example: If two drivers are connected, 10 k Ω and 1/10 W are obtained.

- For I/O signals other than the speed setting, connect to each driver.
- If multiple motors are used with speed differences among them, adjust as follows.
The first driver: Connect a resistor of 1.5 k Ω , 1/20 W to the terminal M on the driver.
The second and subsequent drivers: Connect a variable resistor (VRn) of 5 k Ω , 1/20 W to the terminal M on the driver.
- Keep the number of drivers to 10 units or less in multi-motor control using an external potentiometer.

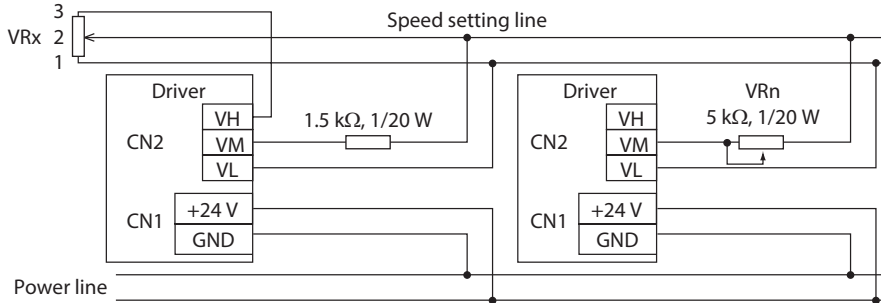

Using external DC voltage

- Use a DC power supply whose current capacity is at least the value calculated by the formula below.

Current capacity (mA) when the number of drivers is n units = 1 mA × n

Example: If two drivers are connected, the current capacity should be at least 2 mA.

- For I/O signals other than the speed setting, connect for each driver.
- If multiple motors are used with speed differences among them, adjust as follows.
The first driver: Connect a resistor of 1.5 k Ω , 1/20 W to the terminal M on the driver.
The second and subsequent drivers: Connect a variable resistor (VRn) of 5 k Ω , 1/20 W to the terminal M on the driver.

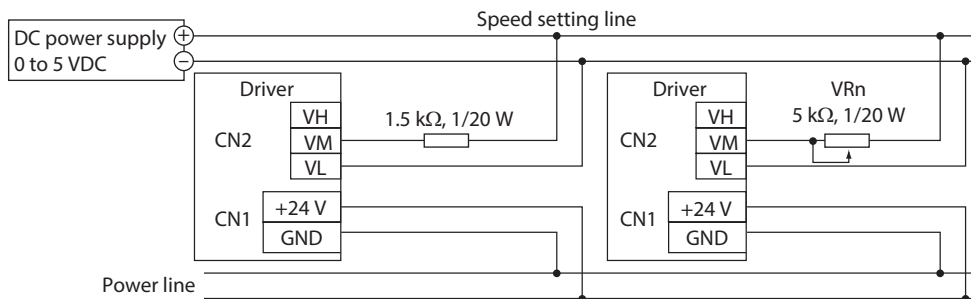

How to adjust the speed difference

To adjust the speed difference among the first motor and the second and subsequent motors, change the "External analog operation speed command offset" parameter. Refer to p.39 for the parameter.

When the speed difference is adjusted by changing the parameter, no resistor for adjusting the speed difference is required.

The speed difference can be adjusted by changing the "setting voltage - rotation speed characteristics" shown in the figure.

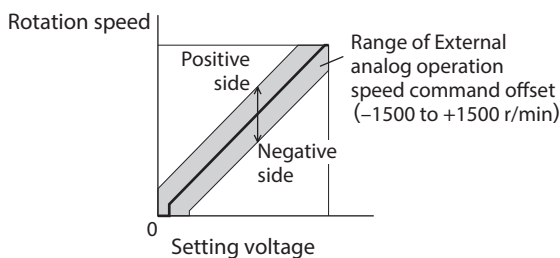

[Example]

- When the speed of the second motor is slower than that of the first motor, set a value for the positive side (0 to +1500 r/min) in the "External analog operation speed command offset" parameter of the second driver.

8 Guidance

If you are new to this product, read this chapter to understand the operating methods along with the operation flow. This is an example how to set operation data and parameters to the driver and operate the motor using a host controller.

Note

- Before operating the motor, check the surrounding conditions to ensure safety.
- After changing a parameter, it may be required to perform Configuration or turn on the driver power again in order to update the new setting.
Refer to p.102 for details about the update timing.

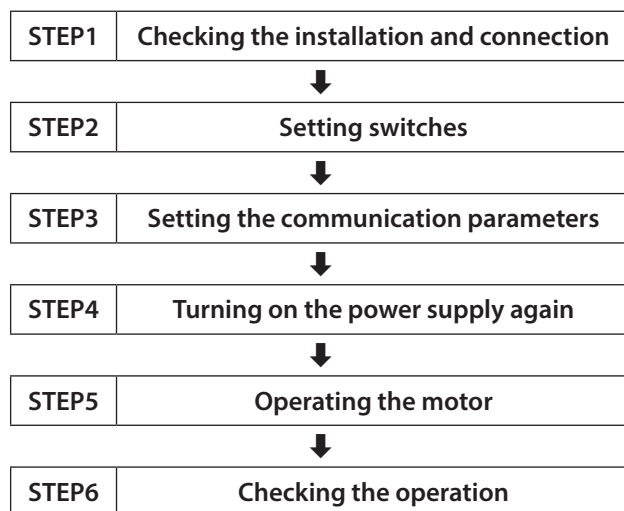

This operation is performed under the following conditions.

- Number of drivers connected: 1 unit
- Address number: 1 (set by the switch)
- Transmission rate: 115,200 bps
- Termination resistor: Set to be enable

STEP1 Checking the installation and connection

Connection diagram

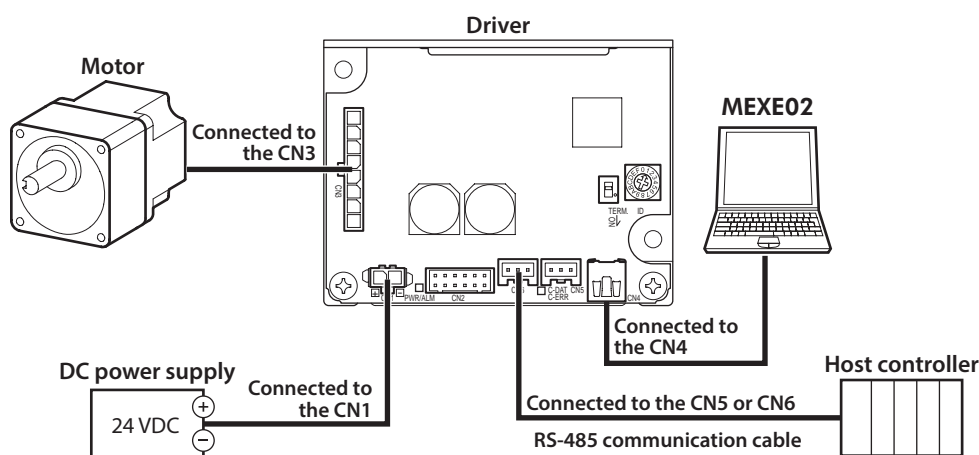

■ CN5/CN6 pin assignment

Pin No.	Signal name	Description
1	TR+	RS-485 communication signal (+)
2	TR-	RS-485 communication signal (-)
3	GND	GND

STEP2 Setting switches

Set the termination resistor and the address number with the switches.



Turn off the driver power before setting the switches. If the switches are set while the power is still on, the new switch settings will not be enabled.

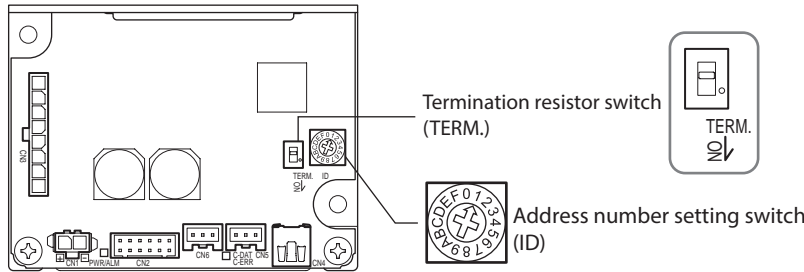

● **Setting the address number setting switch**

Set the address number (slave address) using the address number setting switch. Make sure each address number (slave address) you set for each driver is unique.

Address number (slave address) 0 is reserved for broadcasting, so do not use this address.

ID switch	Address number	ID switch	Address number
0	Not used.	8	8
1	1 (factory setting)	9	9
2	2	A	10
3	3	B	11
4	4	C	12
5	5	D	13
6	6	E	14
7	7	F	15



The address number can also be set with the "Communication ID" parameter. (p.49)
If the address number is set using the parameter in a state where communication is not established, connect the **MEXE02** to set.

● **Setting the termination resistor**

Set the termination resistor (120 Ω) of RS-485 communication to the driver located the farthest away (positioned at the end) from the host controller.

Set the termination resistor switch to enable the termination resistor. (OFF ⇒ ON)

Factory setting: OFF (termination resistor disabled)

STEP3 Setting the communication parameters

Turn on the driver power supply and check the communication parameters listed below using the **MEXE02**.

If communication is not established, reconsider the communication parameters of the driver.

Parameter name	Factory setting
Communication ID	-1: The switch setting of the driver is followed
Baudrate	4: 115,200 bps
Communication order	0: Even Address-High Word & Big-Endian
Communication parity	1: Even parity
Communication stop bit	0: 1 bit
Transmission waiting time	30 (3.0 ms)
Silent interval	0.0: Set automatically

STEP4 Turning on the power supply again

The address number setting switch and the communication parameters of the driver will be updated after turning on the power supply again.

STEP5 Operating the motor

Send a message to operate the motor. As an example, this section explains how to perform the following operation.

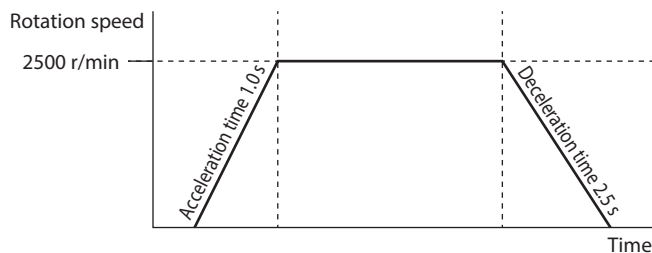

1. Send the following query to set the operation data.

Communication data (HEX)	Description
01 10 07 80 00 02 04 00 00 00 DD FF	Sets the operation data No.0 rotation speed setting method to "0: Digital setting." (Factory setting)
01 10 09 00 00 02 04 00 00 00 99 FF	Sets the operation data No.0 torque limiting value setting method to "0: Digital setting." (Initial value)
01 10 04 80 00 02 04 00 00 09 C4 CE CC	Sets the setting value of the operation data No.0 rotation speed to "2500 r/min."
01 10 07 00 00 02 04 00 00 00 64 D4 74	Sets the setting value of the operation data No.0 torque limiting value to "100%."
01 10 06 00 00 02 04 00 00 00 0A 58 08	Sets the setting value of the operation data No.0 acceleration time to "1.0 s."
01 10 06 80 00 02 04 00 00 00 19 11 A5	Sets the setting value of the operation data No.0 deceleration time to "2.5 s."

* If the indirect reference function is used, each operation data item of the operation data No.0 can be set with consecutive addresses. (p.87)



Set the transmission interval of frames sent from the master should be longer than the silent interval (C3.5) after receiving the response. It should be 2.5 ms or more when the transmission rate is 115,200 bps. Refer to p.74 for details.

2. Send the following query to perform operation.

Communication data (HEX)	Description
01 10 00 7C 00 02 04 00 00 00 18 F4 D4	Turns the START/STOP and RUN/BRAKE inputs ON (operation start of operation data No.0)
01 10 00 7C 00 02 04 00 00 00 10 F5 12	Turns the START/STOP input OFF

3. Check the motor rotates without any problem.

STEP6 Checking the operation

If the motor does not operate, check the following points.

- Is any alarm present?
- Are the power supply, the motor, and the RS-485 communication cable connected securely?
- Are the slave address, the transmission rate, and the termination resistor set correctly?
- Is the C-DAT/C-ERR LED unlit? Or is it lit in red? (A communication error is generated)

9 Parameter

Operation data and parameters are set using the **MEXE02** or RS-485 communication.

Operation data and parameters having set are saved in the RAM or non-volatile memory. The parameters in the RAM are erased once the power supply is shut off, but the parameters in the non-volatile memory are remained to store even if the power supply is shut off.



- The non-volatile memory can be rewritten approximately 100,000 times.
- When changing a parameter that requires to turn on the power supply again to update data, be sure to save it in the non-volatile memory before turning off the power supply.

■ Setting method

● Perform "Data writing" using the MEXE02.

When executed, written operation data or parameter is saved in the non-volatile memory.

● Perform "Write batch NV memory" via RS-485 communication.

When a parameter is set via RS-485 communication, they are saved in the RAM.

To save the parameters stored in the RAM to the non-volatile memory, execute the "Write batch NV memory" of the maintenance command.

■ Update timing

When a parameter is changed, the timing to update the new value varies depending on the parameter. See the following four types.

- Update immediately.....Recalculation and setup are immediately executed when the parameter is written.
- Update after operation stop.....Recalculation and setup are executed when the operation is stopped.
- Update after executing Configuration.....Recalculation and setup are executed after Configuration is executed. Configuration is executed using the **MEXE02** or the maintenance command of RS-485 communication.
- Update after turning on the power againRecalculation and setup are executed after the power supply is turned on again.

● Notation rules

In this part, each update timing is represented in an alphabet.
A: Update immediately
B: Update after operation stop
C: Update after executing Configuration or turning on the power again
D: Update after turning on the power again

■ Parameter types

- Operation data (p.22)
- Operation data extension setting (p.37)
- Operation and I/O action (p.40)
- Alarm and information settings (p.44)
- Monitor setting (p.47)
- Direct-IN function selection (p.48)
- Direct-OUT function selection (p.48)
- Remote-IN function selection (p.48)
- Remote-OUT function selection (p.48)
- Communication and I/F function (p.49)

9.1 Parameter list

	Parameter name	Setting range	Factory setting	Update	Reference page
Operation data extension setting	Speed upper limit	80 to 3150 r/min	3150	B	P.37
	Speed lower limit	80 to 3150 r/min	80		
	Torque limiting maximum value	0 to 200%	200		
	External setting method	0: External analog setting device 1: PWM signal input	0	C	
	External analog operation speed command gain	0 to 3150 r/min/V	640	A	
	External analog operation speed command offset	-1500 to +1500 r/min	0		
	External analog torque limiting gain	0 to 200%/V	43		
	External analog torque limiting offset	-100 to +100%	0		
Operation and I/O action	Impact softening filter	0: No filter 1: Filter 1 2: Filter 2	0	B	P.40
	Deceleration mode selection	0: Deceleration stop 1 1: Deceleration stop 2 2: Deceleration stop 3	0	C	
	Motor rotation direction	0: +=CCW 1: +=CW	1		
	Operation input mode selection	0: 2-Wire mode 1: 3-Wire mode	1		
	VA detection width	1 to 400 r/min	200	A	
	Load holding function selection	0: Disable 1: Enable	0	C	
	Load holding torque limiting setting value	-1 to +50%	-1 (Operation data is followed)	A	
Alarm and information settings	Overload alarm detection time	0.1 to 10.0 s	10.0	A	P.44
	Prevention of operation at power-on alarm	0: Disable 1: Enable	1	C	
	Information auto clear	0: Disable 1: Enable	1	A	
	Driver temperature information	40 to 85 °C	85		
	Overvoltage information	18.0 to 38.0 VDC	38.0		
	Undervoltage information	18.0 to 38.0 VDC	18.0		
	Load information	0: Disable 1 to 200%	0		
	Speed information	0: Disable 1 to 5200 r/min	0		
	RS-485 communication error information	1 to 10 times	3		
	Tripmeter information	0.0: Disable 0.1 to 99999999.9 kRev	0.0		
	Odometer information	0.0: Disable 0.1 to 99999999.9 kRev	0.0		
	Main power supply time information	0: Disable 1 to 99999999 min	0		
	Main power supply count information	0: Disable 1 to 99999999 times	0		
	Rotation amount meter information (positive side)	-2147483648 to +2147483647 rev	+2147483647		
Rotation amount meter information (negative side)	-2147483648 to +2147483647 rev	-2147483648			

Parameter name		Setting range	Factory setting	Update	Reference page
Alarm and information settings	INFO action (Driver temperature information (INFO-DRVTMP))	0: INFO action is not applied Information bit output: Applied • INFO output: Not applied • LED: Not applied 1: INFO action is applied Information bit output: Applied • INFO output: Applied • LED: Applied	1	A	P.44
	INFO action (Overvoltage information (INFO-OVOLT))				
	INFO action (Undervoltage information (INFO-UVOLT))				
	INFO action (Load information (INFO-LOAD))				
	INFO action (Speed information (INFO-SPD))				
	INFO action (Operation data setting error information (INFO-SET-E))				
	INFO action (Operation prohibited information (INFO-DRV))				
	INFO action (RS-485 communication error information (INFO-NET-E))				
	INFO action (Rotation amount meter information (INFO-REV))				
	INFO action (Tripmeter information (INFO-TRIP))				
	INFO action (Odometer information (INFO-ODO))				
	INFO action (Torque limiting value setting error information (INFO-TRQ-DE))				
	INFO action (Rotation speed setting error information (INFO-SPD-DE))				
	INFO action (Main power supply time information (INFO-PTIME))				
	INFO action (Main power supply count information (INFO-PCOUNT))				
	INFO action (Operation start limit mode information (INFO-DSLMTD))				
	INFO action (I/O test mode information (INFO-IOTEST))				
	INFO action (Configuration request information (INFO-CFG))				
	INFO action (Power cycling request information (INFO-RBT))				
Monitor setting	Driver user name	Up to 16 characters	–	A	P.47
	Speed reduction ratio	100 to 9999	100		
	Speed reduction ratio digit setting	0: ×1 1: ×0.1 2: ×0.01	2		
	Speed increasing ratio	1.00 to 2.00	1.00		
Direct-IN function selection Direct-OUT function selection	D-IN0 input function selection	Refer to p.61.	58: FWD (START/STOP)*	C	P.48
	D-IN1 input function selection		59: REV (RUN/BRAKE)*		
	D-IN2 input function selection		72: STOP-MODE (FWD/REV)*		
	D-IN3 input function selection		64: M0		
	D-IN4 input function selection	8: ALM-RST			
	D-IN0 input logic level setting	0: Not invert 1: Invert	0: Not invert		
	D-IN1 input logic level setting		0: Not invert		
	D-IN2 input logic level setting		0: Not invert		
	D-IN3 input logic level setting		0: Not invert		
	D-IN4 input logic level setting	0: Not invert			
	D-OUT0 output function selection	Refer to p.62.	147: SPEED-OUT		
	D-OUT1 output function selection		130: ALM-B		
	D-OUT0 output logic level setting		0: Not invert		
	D-OUT1 output logic level setting		0: Not invert		

* If the 3-wire mode is selected with the "Operation input mode selection" parameter, the signal in the parentheses () will be applied.

Parameter name	Setting range	Factory setting	Update	Reference page
Remote-IN function selection, Remote-OUT function selection	R-IN0 input function selection	64: M0	C	P.48
	R-IN1 input function selection	65: M1		
	R-IN2 input function selection	66: M2		
	R-IN3 input function selection	58: FWD (START/STOP)*		
	R-IN4 input function selection	59: REV (RUN/BRAKE)*		
	R-IN5 input function selection	72: STOP-MODE (FWD/REV)*		
	R-IN6 input function selection	0: Not used		
	R-IN7 input function selection	8: ALM-RST		
	R-IN8 input function selection	0: Not used		
	R-IN9 input function selection	0: Not used		
	R-IN10 input function selection	0: Not used		
	R-IN11 input function selection	0: Not used		
	R-IN12 input function selection	0: Not used		
	R-IN13 input function selection	0: Not used		
	R-IN14 input function selection	0: Not used		
	R-IN15 input function selection	0: Not used		
	R-OUT0 output function selection	64: M0_R		
	R-OUT1 output function selection	65: M1_R		
	R-OUT2 output function selection	66: M2_R		
	R-OUT3 output function selection	58: FWD (START/STOP)_R*		
	R-OUT4 output function selection	59: REV (RUN/BRAKE)_R*		
	R-OUT5 output function selection	72: STOP-MODE (FWD/REV)_R*		
	R-OUT6 output function selection	135: INFO		
	R-OUT7 output function selection	129: ALM-A		
	R-OUT8 output function selection	136: SYS-BSY		
	R-OUT9 output function selection	148: DIR		
	R-OUT10 output function selection	168: MPS		
	R-OUT11 output function selection	0: Not used		
	R-OUT12 output function selection	0: Not used		
	R-OUT13 output function selection	134: MOVE		
R-OUT14 output function selection	141: VA			
R-OUT15 output function selection	140: TLC			
Communication and I/F function	USB-ID enable	0: Disable 1: Enable	1	D
	USB-ID	0 to 999,999,999	0	
	USB-PID	0 to 31	0	
	RS-485 Receive packet monitor	0: All 1: Only own address	0	A
	Communication ID	-1: The switch setting of the driver is followed 1 to 15: Slave address 1 to 15 ※ Do not use 0.	-1	D
	Baudrate	0: 9,600 bps 1: 19,200 bps 2: 38,400 bps 3: 57,600 bps 4: 115,200 bps 5: 230,400 bps	4	
	Communication order	0: Even Address-High Word & Big-Endian 1: Even Address-Low Word & Big-Endian 2: Even Address-High Word & Little-Endian 3: Even Address-Low Word & Little-Endian	0	
	Communication parity	0: None 1: Even parity 2: Odd parity	1	
Communication stop bit	0: 1 bit 1: 2 bits	0		

* If the 3-wire mode is selected with the "Operation input mode selection" parameter, the signal in the parentheses () will be applied.

Parameter name	Setting range	Factory setting	Update	Reference page
RS-485 communication timeout alarm	0: Not monitored 1 to 10000 ms	0	A	P.49
RS-485 communication error alarm	0: Disable 1 to 10 times	3		
Transmission waiting time	0.0 to 1000.0 ms	3.0	D	
Silent interval	0.0: Set automatically 0.1 to 10.0 ms	0.0		
Slave error response mode	0: Normal response is returned 1: Exception response is returned	1	A	
Initial group ID	-1: Disable (no group transmission) 1 to 15: Group ID ※ Do not use 0.	-1	C	
Communication and I/F function	0 to 65535 (0 to FFFFh)	576: Operation data No.0 rotation speed	A	
		896: Operation data No.0 torque limiting value		
		768: Operation data No.0 acceleration time		
		832: Operation data No.0 deceleration time		
		62: Driver input command		
		98: Selection number		
		103: Feedback speed		
		108: Load factor		
		63: Remote output		
		64: Present alarm		
		123: Information		
		124: Driver temperature		
		163: Inverter voltage		
		157: Rotation amount meter		
		127: Tripmeter		
		126: Odometer		
		160: Main power supply count		
		161: Main power supply time		
		184: I/O status 1		
		185: I/O status 2		
		186: I/O status 3		
		187: I/O status 4		
		188: I/O status 5		
		189: I/O status 6		
		190: I/O status 7		
		191: I/O status 8		
		0: Not used		
		0: Not used		
		0: Not used		
		0: Not used		
		0: Not used		
0: Not used				

9.2 Operation data extension setting

Using the operation data extension setting, functions or settings for the rotation speed and the torque limiting can be changed.

A: Update immediately, B: Update after operation stop, C: Update after executing Configuration

Parameter name	Description	Setting range	Factory setting	Update
Speed upper limit	Sets the upper limit value of the rotation speed command.	80 to 3150 r/min	3150	B
Speed lower limit	Sets the lower limit value of the rotation speed command.	80 to 3150 r/min	80	
Torque limiting maximum value	Sets the upper limit value of the torque limiting command.	0 to 200%	200	
External setting method	Selects whether to use the external analog setting device or the PWM signal input in the setting method.	0: External analog setting device 1: PWM signal input	0	C
External analog operation speed command gain	Sets the speed command per 1 VDC of the input voltage by the external analog setting device.	0 to 3150 r/min/V	640	A
External analog operation speed command offset	Sets the offset of the speed command input by the external analog setting device.	-1500 to +1500 r/min	0	
External analog torque limiting gain	Sets the torque limiting value per 1 VDC of the input voltage by the external analog setting device.	0 to 200%/V	43	
External analog torque limiting offset	Sets the offset of the torque limiting input by the external analog setting device.	-100 to +100%	0	

Speed upper limit, Speed lower limit

The rotation speed can be set to 80 to 3150 r/min and 0 r/min*. Using the "Speed upper limit" parameter and the "Speed lower limit" parameter, the rotation speed range of 80 to 3150 r/min can be limited.

* When the rotation speed is set to 0 r/min, the "Speed lower limit" parameter is not applied.

Setting range of rotation speed

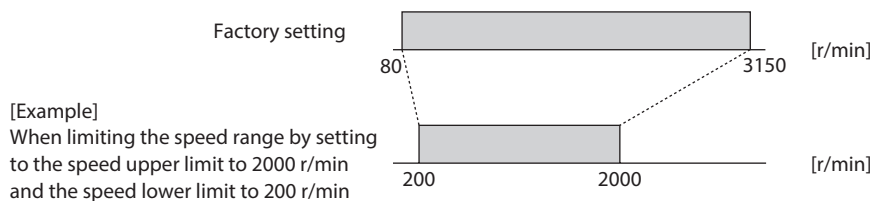

Speed upper limit

Set the upper limit value of the rotation speed with the "Speed upper limit" parameter.

If the rotation speed exceeding the "Speed upper limit" is already set in the operation data, the rotation speed is limited to the value set in the "Speed upper limit" parameter.

Setting example: When 2500 r/min is set in the "Speed upper limit" parameter while the setting method of the rotation speed is external DC voltage.

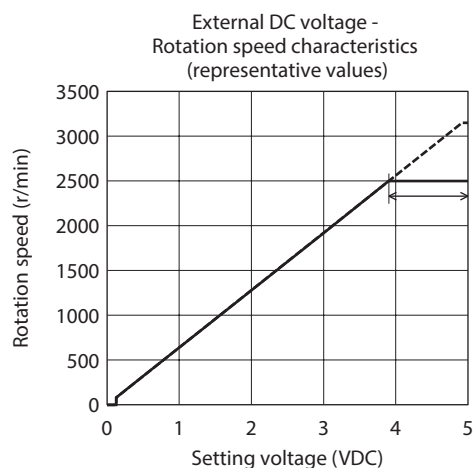

Broken line: Factory setting

Solid line: When 2500 r/min is set in the "Speed upper limit" parameter

←→ : Rotation speed setting error information

Speed lower limit

Set the lower limit value of the rotation speed with the "Speed lower limit" parameter.
 If the rotation speed below the "Speed lower limit" is already set in the operation data, the rotation speed is limited to the value set in the "Speed lower limit" parameter.

Setting example: When 500 r/min is set in the "Speed lower limit" parameter while the setting method of the rotation speed is external DC voltage.

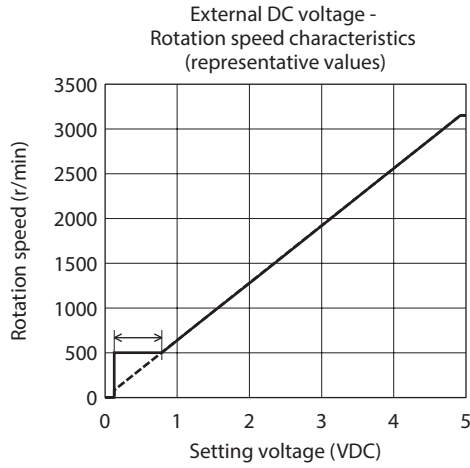

Broken line: Factory setting
 Solid line: When 500 r/min is set in the "Speed lower limit" parameter
 ←→ : Rotation speed setting error information

memo When the rotation speed being operated is limited to the value set in the "Speed upper limit" parameter or the "Speed lower limit" parameter, the rotation speed setting error (INFO-SPD-DE) information is generated.

A speed lower than 80 r/min (0 to 79 r/min) is excluded from the speed limitation of the "Speed lower limit" parameter. (Digital setting, external analog setting device, PWM signal input)
 If a negative value is set with the "External analog operation speed command offset" parameter, the motor will not start rotating until the command value is 80 r/min or higher.

■ Torque limiting maximum value

The setting range of the torque limiting value is set to 0 to 200% at the time of shipment.
 Set when the upper limit is provided.
 If the torque limiting value exceeding the "Torque limiting maximum value" is already set in the operation data, the torque limiting value is limited to the value set in the "Torque limiting maximum value" parameter.

memo When the torque is limited to the torque limiting value set in the "Torque limiting maximum value" parameter, the torque limiting value setting error (INFO-TRQ-DE) information is generated.

Setting example: When 160% is set in the "Torque limiting maximum value" parameter while the setting method of the torque limiting value is external DC voltage.

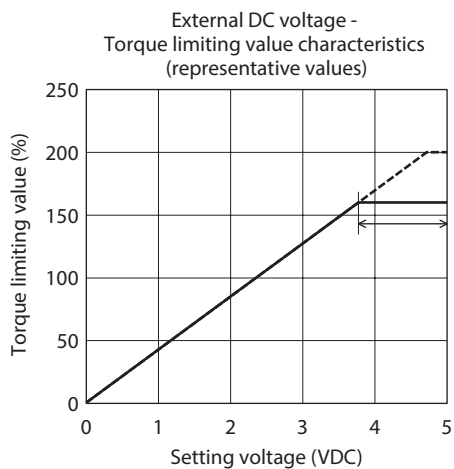

Broken line: Factory setting
 Solid line: When 160% is set in the "Torque limiting maximum value" parameter
 ←→ : Torque limiting value setting error information

Note If the torque limiting function is disabled, the maximum value of the output torque is the peak torque (200%) not the value set in the "Torque limiting maximum value" parameter. Also, the torque limiting value setting error information is not generated.

External setting method

This parameter is used to select the external analog setting device (external potentiometer or external DC voltage) or PWM signal input. The external analog setting device is set at the time of shipment.

Selecting the PWM signal input and inputting the PWM signal can also set the rotation speed or the torque limiting value.

The rotation speed or the torque limiting value changes according to the duty cycle of input PWM signal.

External analog operation speed command gain, External analog operation speed command offset

If gain and offset are adjusted when the rotation speed is set using the external analog setting device, the slope of the speed command can be changed, and the speed can finely be adjusted.

Note

The rotation speed corresponding to the voltage value varies depending on the product.

Gain adjustment and offset adjustment for rotation speed

Adjust using the following parameters.

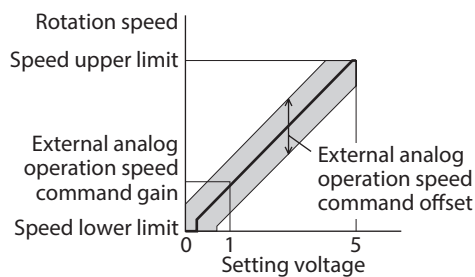

$$\text{Analog speed command} = \text{External analog operation speed command gain} \times \text{Setting voltage} + \text{External analog operation speed command offset}$$

$$\text{External analog operation speed command gain}^* = \frac{\text{Speed upper limit}}{\text{Maximum value of setting voltage}}$$

* If the motor does not reach the speed upper limit when the setting voltage is the maximum value, increase the value in the "External analog operation speed command gain" parameter.

Setting example: When the motor is operated linearly while the maximum rotation speed is set to 1500 r/min

Set a value of 1500 in the "Speed upper limit" parameter first, and set 300 in the "External analog operation speed command gain" parameter.

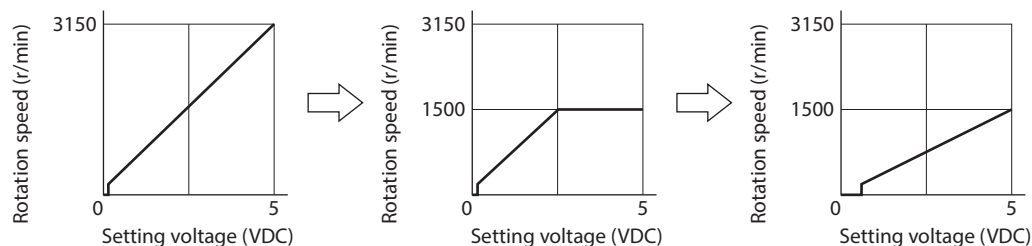

Refer to "How to adjust the speed difference" on p.28 for how to use the "Analog operation speed command offset" parameter.

■ External analog torque limiting gain, External analog torque limiting offset

If gain and offset are adjusted when the torque limiting value is set using the external analog setting device, the slope of the torque limiting value command can be changed, and the torque limiting value can finely be adjusted.



The torque limiting value corresponding to the voltage value varies depending on the product.

Gain adjustment and offset adjustment for torque limiting value

Adjust using the following parameters.

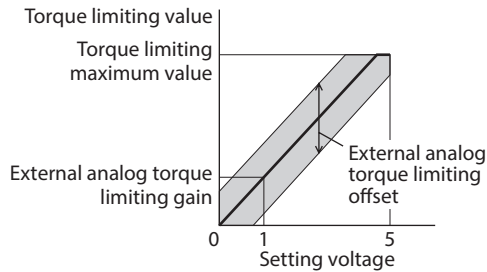

$$\text{External analog torque limiting gain*} = \frac{\text{Torque limiting maximum value}}{\text{Maximum value of setting voltage}}$$

* If the motor does not reach the torque upper limit when the setting voltage is the maximum value, increase the value in the "External analog torque limiting gain" parameter.

Setting example: When the torque limiting value is adjusted up to 100% using the external DC voltage of 0 to 5 VDC

Set a value of 100 in the "Torque limiting maximum value" parameter first, and set 20 in the "External analog torque limiting gain" parameter.

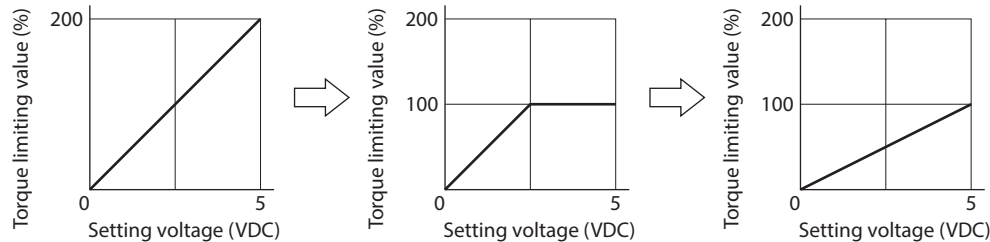

9.3 Operation and I/O action

A: Update immediately, B: Update after operation stop, C: Update after executing Configuration

Parameter name	Description	Setting range	Factory setting	Update
Impact softening filter	This is a function to suppress an impact being applied to a load at starting or stopping.	0: No filter 1: Filter 1 2: Filter 2	0	B
Deceleration mode selection	Selects how to stop the motor at deceleration stop.	0: Deceleration stop 1 1: Deceleration stop 2 2: Deceleration stop 3	0	C
Motor rotation direction	Sets the motor rotation direction. (Sets the rotation direction when turning the FWD input ON if the "2-wire mode" is selected with the "Operation input mode selection" parameter. Sets the rotation direction when turning the FWD/REV input ON if the "3-wire mode" is selected.)	0: +=CCW 1: +=CW	1	
Operation input mode selection	Selects whether the operation input mode is used in the 2-wire mode or the 3-wire mode.	0: 2-Wire mode 1: 3-Wire mode.	1	
VA detection width	Sets the detection width for the VA output.	1 to 400 r/min	200	A
Load holding function selection	Selects whether to generate a force to hold the shaft electrically when the motor stops.	0: Disable 1: Enable	0	C
Load holding torque limiting setting value	Sets the limiting value of the load holding torque. If -1 is set, the torque limiting value set to the selected operation data number is applied.	-1 to +50%	-1 (Operation data is followed)	A

■ Impact softening filter

The impact softening filter is a function to perform a filter processing to the set acceleration time and deceleration time, and to suppress an impact being applied to a transferred load at starting or stopping. The motor accelerates slowly at starting and decelerates slowly at stopping.

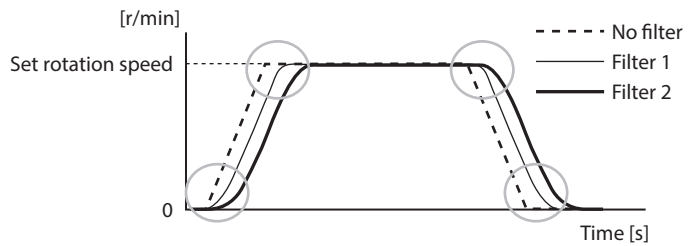

If the "Impact softening filter" is enabled, the actual acceleration time/deceleration time may be longer than the acceleration time/deceleration time having set.

■ Deceleration mode selection

The motor stopping movement can be selected. Set according to the type of a power supply used or the motor stopping movement.

However, note the deceleration stop time varies depending on a load condition.

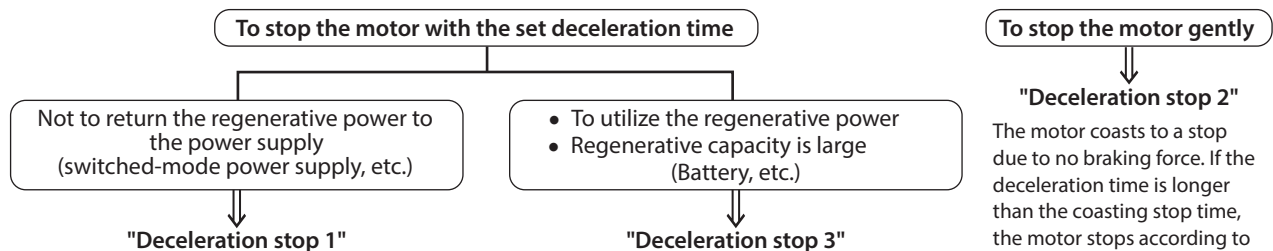

This is the stopping method that regenerative power generated at deceleration stop is consumed in the motor and driver not to return to the power supply side.

When the deceleration time is short, the output torque may become smaller than the set torque limiting value due to regenerative energy, causing the stopping time to increase.

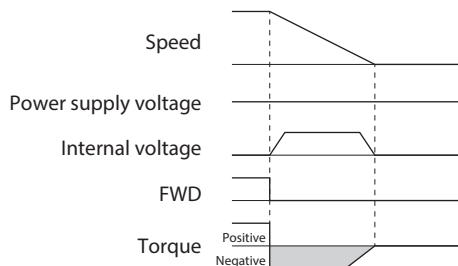

This is the stopping method that regenerative power generated at deceleration stop is returned to the power supply side.

Also, use this setting when regenerative power is used in other equipment.

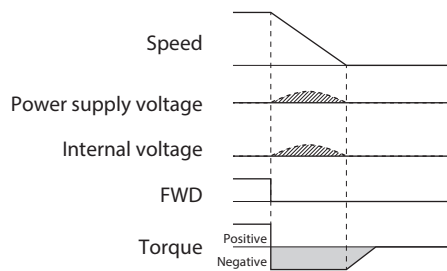

● **Note when using a switched-mode power supply in "Deceleration stop 3"**

If a power supply with a small regenerative capacity is combined, the voltage may rise as indicated by hatched areas, causing a trip in the power supply or an alarm of the driver to generate.

When performing regeneration operation continuously, use a power supply with a large regenerative capacity.

Motor rotation direction

Even when a gearhead with a gear ratio which rotation direction is opposite to the motor output shaft is used, the rotation direction of the gearhead output shaft when the FWD/REV input * is turned ON can be set to the same as that of the motor. Rotation direction of the motor output shaft ⇒ p.27

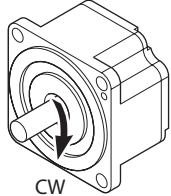
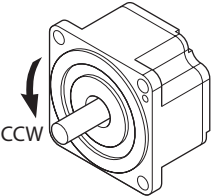
Input signal	Rotation direction when the input signal is turned ON	
	"Motor rotation direction" parameter +=CW	+=CCW
FWD/REV*		

* This is the signal when the 3-wire mode is selected. When the 2-wire mode is selected, it is the FWD input.

Operation input mode selection

The input mode of the operation input signal can be changed from the 3-wire mode to the 2-wire mode.

3-Wire mode

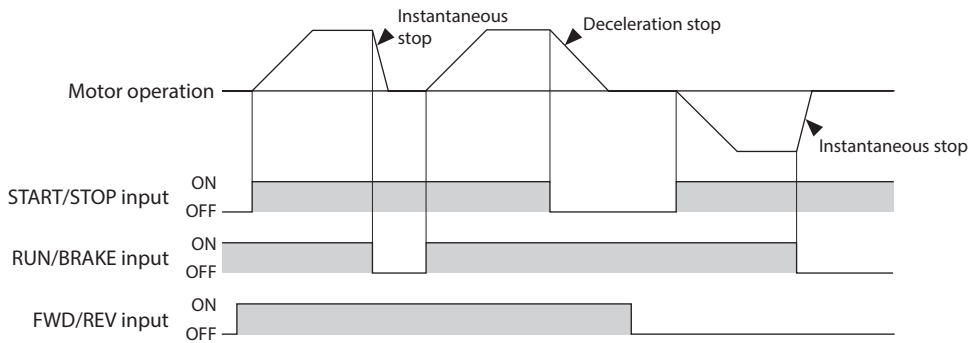

2-Wire mode

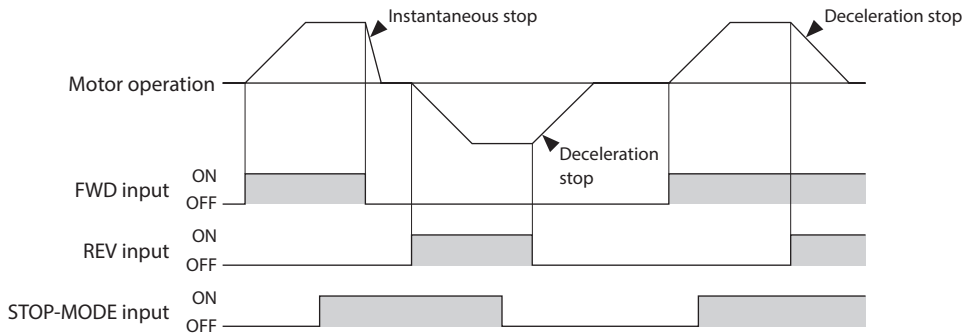

■ VA detection width

The VA output is output when the motor reaches the plus or minus range of the "VA detection width" with respect to the set rotation speed.

The VA detection width can be set in a range of 1 to 400 r/min with respect to the set rotation speed. (Factory setting: 200 r/min)

Example When the motor speed changes from the setting speed 1 to the setting speed 2

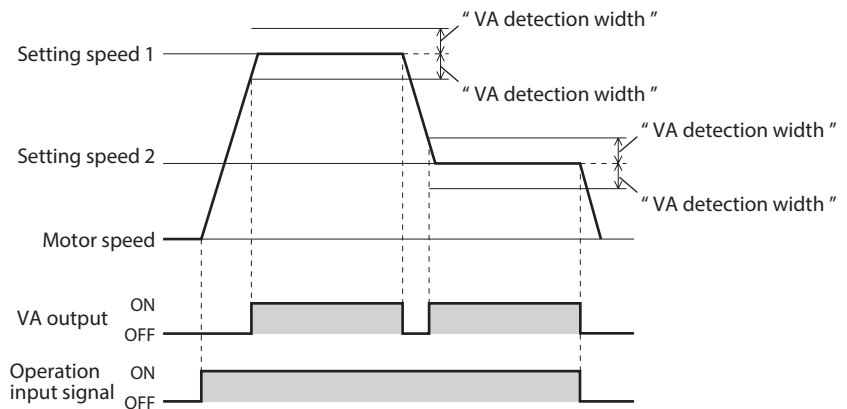

■ "Load holding function selection" parameter

When 1 (enabled) is set, a force to hold the shaft electrically can be generated when the motor stops (load holding torque).

The factory setting is 0 (disable).

If the angle of the motor output shaft is changed about 15°, a holding force is generated.

■ "Load holding torque limiting setting value" parameter

The load holding torque limiting value is set with this parameter.

If -1 is set, the torque limiting value set to the selected operation data number is applied.

When the setting value of the torque limiting value exceeds 50% of the rated torque, the load holding torque is limited to a maximum of 50%.

If a value of 0 to 50% is set, the torque limiting value having set is applied.

Note

- Do not use a motor in a vertical application. If the power supply to the driver is turned off or if an alarm is generated, the holding force is lost.
This function cannot be used for keeping the load position when the motor stops.
- If the load holding function is enabled, the time until the motor stops will be longer than when set to disable according to the setting or load conditions. In addition, the motor output shaft may vibrate when the motor stops.

9.4 Alarm and information settings

Refer to p.135 for details about alarms.

Refer to p.139 for details about information.

A: Update immediately, C: Update after executing Configuration

Parameter name	Description	Setting range	Factory setting	Update
Overload alarm detection time	Sets the detection time of the overload alarm.	0.1 to 10.0 s	10.0	A
Prevention of operation at power-on alarm	Sets whether to enable or disable the prevention of operation at power-on alarm.	0: Disable 1: Enable	1	C
Information auto clear	This is a function to clear the information status automatically when the cause of the generated information was removed.	0: Disable 1: Enable	1	A
Driver temperature information	Sets the condition in which the driver temperature information is generated.	40 to 85 °C	85	
Overvoltage information	Sets the condition in which the overvoltage information is generated.	18.0 to 38.0 VDC	38.0	
Undervoltage information	Sets the condition in which the undervoltage information is generated.	18.0 to 38.0 VDC	18.0	
Load information	Sets the condition in which the load information is generated.	0: Disable 1 to 200%	0	
Speed information	Sets the condition in which the speed information is generated.	0: Disable 1 to 5200 r/min	0	
RS-485 communication error information	Sets the condition in which the RS-485 communication error information is generated.	1 to 10 times	3	
Tripmeter information	Sets the condition in which the tripmeter information is generated.	0.0: Disable 0.1 to 99999999.9 kRev	0.0	
Odometer information	Sets the condition in which the odometer information is generated.	0.0: Disable 0.1 to 99999999.9 kRev	0.0	
Main power supply time information	Sets the condition in which the main power supply time information is generated.	0: Disable 1 to 99999999 min	0	
Main power supply count information	Sets the condition in which the main power supply count information is generated.	0: Disable 1 to 99999999 times	0	
Rotation amount meter information (positive side)	Sets the condition in which the rotation amount meter information (positive side) is generated.	-2147483648 to +2147483647 rev	+2147483647	
Rotation amount meter information (negative side)	Sets the condition in which the rotation amount meter information (negative side) is generated.	-2147483648 to +2147483647 rev	-2147483648	

A: Update immediately

Parameter name	Description	Setting range	Factory setting	Update		
INFO action (Driver temperature information (INFO-DRVTMP))	Sets the INFO output and LED status when corresponding information is generated.	0: INFO action is not applied Information bit output: Applied • INFO output: Not applied • LED: Not applied	1	A		
INFO action (Overvoltage information (INFO-OVOLT))						
INFO action (Undervoltage information (INFO-UVOLT))						
INFO action (Load information (INFO-LOAD))						
INFO action (Speed information (INFO-SPD))						
INFO action (Operation data setting error information (INFO-SET-E))						
INFO action (Operation prohibited information (INFO-DRV))						
INFO action (RS-485 communication error information (INFO-NET-E))						
INFO action (Rotation amount meter information (INFO-REV))						
INFO action (Tripmeter information (INFO-TRIP))						
INFO action (Odometer information (INFO-ODO))					This does not affect the bit output status of each information.	1: INFO action is applied Information bit output: Applied • INFO output: Applied • LED: Applied
INFO action (Torque limiting value setting error information (INFO-TRQ-DE))						
INFO action (Rotation speed setting error information (INFO-SPD-DE))						
INFO action (Main power supply time information (INFO-PTIME))						
INFO action (Main power supply count information (INFO-PCOUNT))						
INFO action (Operation start limit mode information (INFO-DSLMTD))						
INFO action (I/O test mode information (INFO-IOTEST))						
INFO action (Configuration request information (INFO-CFG))						
INFO action (Power cycling request information (INFO-RBT))						

■ Overload alarm detection time

The "Overload alarm detection time" parameter is used to change the time after the motor output torque exceeded the overload detection level until the overload alarm is detected. The overload alarm is generated if a load exceeding the rated torque was applied to the motor for the time set in the "Overload alarm detection time" parameter (factory setting: 10.0 s).

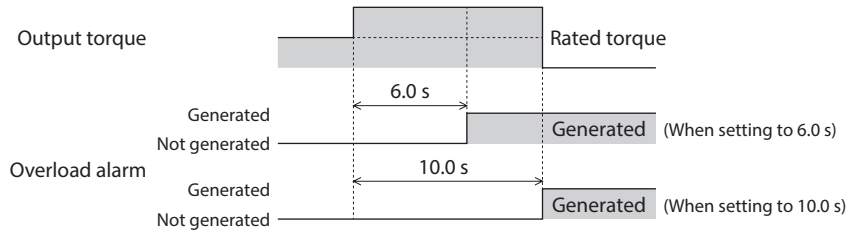

■ Prevention of operation at power-on alarm

The "Prevention of operation at power-on alarm" parameter is set to enable at the time of shipment in order to prevent the motor from rotating suddenly when the power is turned on. If the "Prevention of operation at power-on alarm" parameter is set to disable, the motor can be started operating or stopped by switching ON-OFF of the driver power supply.

• Enable

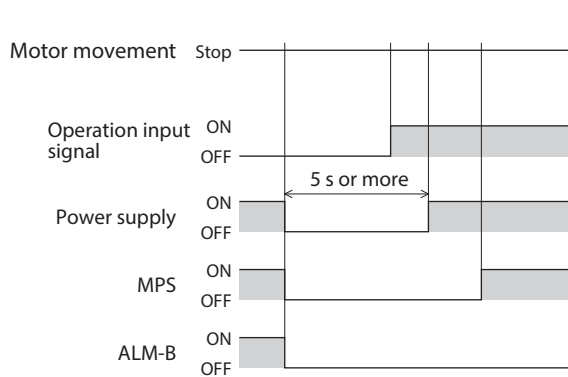

• Disable

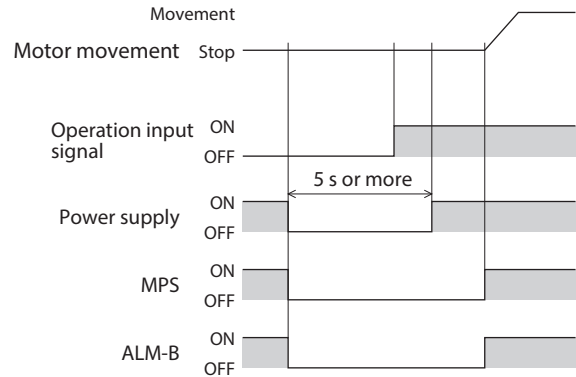

- It takes time for the motor to operate after the power is turned on.
- Provide an interval of at least five seconds until the next time the power supply is turned on after it was turned off. If the interval is short, a large current may flow and the life of the driver may be shortened.

9.5 Monitor setting

A: Update immediately

Parameter name	Description	Setting range	Factory setting	Update
Driver user name	The desired name can be given to the driver used. (The set name can be checked using the unit information monitor.)	Up to 16 characters	-	A
Speed reduction ratio	Sets the speed reduction ratio when the rotation speed of the gearhead output shaft is monitored.	100 to 9999	100	
Speed reduction ratio digit setting	The speed reduction ratio is calculated by multiplying a value in the "Speed reduction ratio" parameter by that in the "Speed reduction ratio digit setting" parameter. The rotation speed of the gearhead output shaft can be checked on the status monitor of the MEXE02 .	0: ×1 1: ×0.1 2: ×0.01	2	
Speed increasing ratio	Sets the speed increasing ratio when the increased rotation speed is monitored. If the speed increasing ratio is set to other than 1, the speed increasing ratio is prioritized. The rotation speed of the gearhead output shaft is shown on the status monitor of the MEXE02 as a value calculated by multiplying a value in the "Speed increasing ratio" parameter by a rotation speed.	1.00 to 2.00	1.00	

■ Speed reduction ratio setting

The rotation speed converted by the speed reduction ratio can be checked on the various monitors of the **MEXE02**.

To display the rotation speed of the gearhead output shaft on the MEXE02

Example) When the speed reduction ratio 15 is set

Set 150 in the "Speed reduction ratio" parameter and ×0.1 in the "Speed reduction ratio digit setting" parameter.

15 that was calculated by the formula "150 × 0.1" was set.

At this time, one-fifteenth speed of the motor rotation speed is displayed.



Rotation speed

To display the conveyor transfer speed on the MEXE02

To display the conveyor transfer speed, calculate the conveyor speed reduction ratio using the formula below, and set to the "Speed reduction ratio" parameter.

$$\text{Conveyor speed reduction ratio} = \frac{1}{\text{Feed rate per motor revolution}} = \frac{\text{Gearhead gear ratio}}{\text{Pulley diameter [m]} \times \pi}$$

If the calculated conveyor speed reduction ratio is used, the conveyor transfer speed is converted as follows.

$$\text{Conveyor transfer speed [m/min]} = \frac{\text{Rotation speed of motor output shaft [r/min]}}{\text{Conveyor speed reduction ratio}}$$

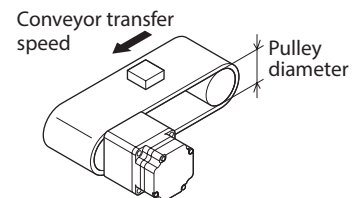

Example) When the pulley diameter is 0.1 m and the gear ratio of the gearhead is 20

$$\text{Conveyor speed reduction ratio} = \frac{\text{Gearhead gear ratio}}{\text{Pulley diameter [m]} \times \pi} = \frac{20}{0.1 \text{ [m]} \times \pi} \cong 63.7$$

From the conversion formula, the conveyor speed reduction ratio is calculated as 63.7 in this example.

If the conveyor speed reduction ratio is 63.7 and the rotation speed of the motor is 1300 r/min, the conveyor transfer speed is converted as follows:

$$\text{Conveyor transfer speed [m/min]} = \frac{1300}{63.7} \cong 20.4$$

9.6 Direct-IN function selection, Direct-OUT function selection

C: Update after executing Configuration

Parameter name	Description	Setting range	Factory setting	Update
D-IN0 input function selection	Selects the input signal to assign to the direct I/O (D-IN0 to D-IN4).	Refer to p.61.	58: FWD (START/STOP)*	C
D-IN1 input function selection			59: REV (RUN/BRAKE)*	
D-IN2 input function selection			72: STOP-MODE (FWD/REV)*	
D-IN3 input function selection			64: M0	
D-IN4 input function selection			8: ALM-RST	
D-IN0 input logic level setting	Sets the logic level for the direct I/O (D-IN0 to D-IN4).	0: Not invert 1: Invert	0: Not invert	
D-IN1 input logic level setting			0: Not invert	
D-IN2 input logic level setting			0: Not invert	
D-IN3 input logic level setting			0: Not invert	
D-IN4 input logic level setting			0: Not invert	
D-OUT0 output function selection	Selects the output signal to assign to the direct I/O (D-OUT0, D-OUT1).	Refer to p.62.	147: SPEED-OUT	
D-OUT1 output function selection			130: ALM-B	
D-OUT0 output logic level setting	Sets the logic level for the direct I/O (D-OUT0, D-OUT1).	0: Not invert 1: Invert	0: Not invert	
D-OUT1 output logic level setting			0: Not invert	

* If the 3-wire mode is selected with the "Operation input mode selection" parameter, the signal in the parentheses () will be applied.

9.7 Remote-IN function selection, Remote-OUT function selection

C: Update after executing Configuration

Parameter name	Description	Setting range	Factory setting	Update
R-IN0 input function selection	Selects the input signal to assign to the remote I/O (R-IN0 to R-IN15).	Refer to p.61.	64: M0	C
R-IN1 input function selection			65: M1	
R-IN2 input function selection			66: M2	
R-IN3 input function selection			58: FWD (START/STOP)*	
R-IN4 input function selection			59: REV (RUN/BRAKE)*	
R-IN5 input function selection			72: STOP-MODE (FWD/REV)*	
R-IN6 input function selection			0: Not used	
R-IN7 input function selection			8: ALM-RST	
R-IN8 input function selection			0: Not used	
R-IN9 input function selection			0: Not used	
R-IN10 input function selection			0: Not used	
R-IN11 input function selection			0: Not used	
R-IN12 input function selection			0: Not used	
R-IN13 input function selection			0: Not used	
R-IN14 input function selection			0: Not used	
R-IN15 input function selection			0: Not used	
R-OUT0 output function selection	Selects the output signal to assign to the remote I/O (R-OUT0 to R-OUT15).	Refer to p.62.	64: M0_R	
R-OUT1 output function selection			65: M1_R	
R-OUT2 output function selection			66: M2_R	
R-OUT3 output function selection			58: FWD (START/STOP)_R*	
R-OUT4 output function selection			59: REV (RUN/BRAKE)_R*	
R-OUT5 output function selection			72: STOP-MODE (FWD/REV)_R*	
R-OUT6 output function selection			135: INFO	
R-OUT7 output function selection			129: ALM-A	
R-OUT8 output function selection			136: SYS-BSY	
R-OUT9 output function selection			148: DIR	
R-OUT10 output function selection			168: MPS	
R-OUT11 output function selection			0: Not used	
R-OUT12 output function selection			0: Not used	
R-OUT13 output function selection			134: MOVE	
R-OUT14 output function selection			141: VA	
R-OUT15 output function selection			140: TLC	

* If the 3-wire mode is selected with the "Operation input mode selection" parameter, the signal in the parentheses () will be applied.

9.8 Communication and I/F function

A: Update immediately, C: Update after executing Configuration, D: Update after turning on the power again

Parameter name	Description	Setting range	Factory setting	Update
USB-ID enable	Sets whether to enable or disable the USB-ID (serial number). When it is set to "Disable," the USB-ID is automatically set to a random number.	0: Disable 1: Enable	1	D
USB-ID	Sets the USB-ID (serial number). The COM port at power-on can be fixed.	0 to 999,999,999	0	
USB-PID	Sets the product ID to be displayed in the COM port.	0 to 31	0	
RS-485 Receive packet monitor	Selects the monitoring target in the RS-485 communication.	0: All 1: Only own address	0	A
Communication ID	Sets the address number (slave address).	–1: The switch setting of the driver is followed 1 to 15: Slave address 1 to 15 ※ Do not use 0.	–1	D
Baudrate	Sets the transmission rate.	0: 9,600 bps 1: 19,200 bps 2: 38,400 bps 3: 57,600 bps 4: 115,200 bps 5: 230,400 bps	4	
Communication order	Sets the byte order of 32-bit data. Set when the arrangement of communication data is different from the master.	0: Even Address-High Word & Big-Endian 1: Even Address-Low Word & Big-Endian 2: Even Address-High Word & Little-Endian 3: Even Address-Low Word & Little-Endian	0	
Communication parity	Sets the communication parity.	0: None 1: Even parity 2: Odd parity	1	
Communication stop bit	Sets the communication stop bit.	0: 1 bit 1: 2 bits	0	
RS-485 communication timeout alarm	Sets the condition in which the RS-485 communication timeout alarm is generated.	0: Not monitored 1 to 10000 ms	0	
RS-485 communication error alarm	A communication error alarm is generated when the RS-485 communication error has occurred by the number of times set here.	0: Disable 1 to 10 times	3	A
Transmission waiting time	Sets the transmission waiting time.	0.0 to 1000.0 ms	3.0	D
Silent interval	Sets the silent interval.	0.0: Set automatically 0.1 to 10.0 ms	0.0	
Slave error response mode	Sets the response when the slave error occurred.	0: Normal response is returned 1: Exception response is returned	1	A
Initial group ID	Sets the address of a group (address number of parent slave). It is stored even if the power is turned off.	–1: Disable (no group transmission) 1 to 15: Group ID ※ Do not use 0.	–1	C

Parameter name	Description	Setting range	Factory setting	Update
Indirect reference address setting (0)	Sets the ID of data to be stored in the indirect reference address (0) to the indirect reference address (31).	0 to 65535 (0 to FFFFh)	576: Operation data No.0 rotation speed	A
Indirect reference address setting (1)			896: Operation data No.0 torque limiting value	
Indirect reference address setting (2)			768: Operation data No.0 acceleration time	
Indirect reference address setting (3)			832: Operation data No.0 deceleration time	
Indirect reference address setting (4)			62: Driver input command	
Indirect reference address setting (5)			98: Selection number	
Indirect reference address setting (6)			103: Feedback speed	
Indirect reference address setting (7)			108: Load factor	
Indirect reference address setting (8)			63: Remote output	
Indirect reference address setting (9)			64: Present alarm	
Indirect reference address setting (10)			123: Information	
Indirect reference address setting (11)			124: Driver temperature	
Indirect reference address setting (12)			163: Inverter voltage	
Indirect reference address setting (13)			157: Rotation amount meter	
Indirect reference address setting (14)			127: Tripmeter	
Indirect reference address setting (15)			126: Odometer	
Indirect reference address setting (16)			160: Main power supply count	
Indirect reference address setting (17)			161: Main power supply time	
Indirect reference address setting (18)			184: I/O status 1	
Indirect reference address setting (19)			185: I/O status 2	
Indirect reference address setting (20)			186: I/O status 3	
Indirect reference address setting (21)			187: I/O status 4	
Indirect reference address setting (22)			188: I/O status 5	
Indirect reference address setting (23)			189: I/O status 6	
Indirect reference address setting (24)			190: I/O status 7	
Indirect reference address setting (25)			191: I/O status 8	
Indirect reference address setting (26)			0: Not used	
Indirect reference address setting (27)			0: Not used	
Indirect reference address setting (28)			0: Not used	
Indirect reference address setting (29)			0: Not used	
Indirect reference address setting (30)			0: Not used	
Indirect reference address setting (31)			0: Not used	

■ USB-ID

The USB-ID is a parameter to associate the USB port (COM port number) of a PC with the driver. The COM port number is used when setting the communication port with the **MEXE02**.

If multiple drivers are connected to a PC, the PC allocates empty COM ports to the driver in the connected order. If the driver power is turned on again or if the UBS cable is removed and inserted, the allocated COM port numbers may change because the order of connection recognized by the PC is changed.

● When the USB-ID is not set

COM port number	Connection status
1	Connected
2	Connected
3	Empty
4	Connected
5	Empty
6	Empty

← COM port on the driver that the power was supplied first

← COM port on the driver that the power was supplied second

← COM port on the driver that the power was supplied third

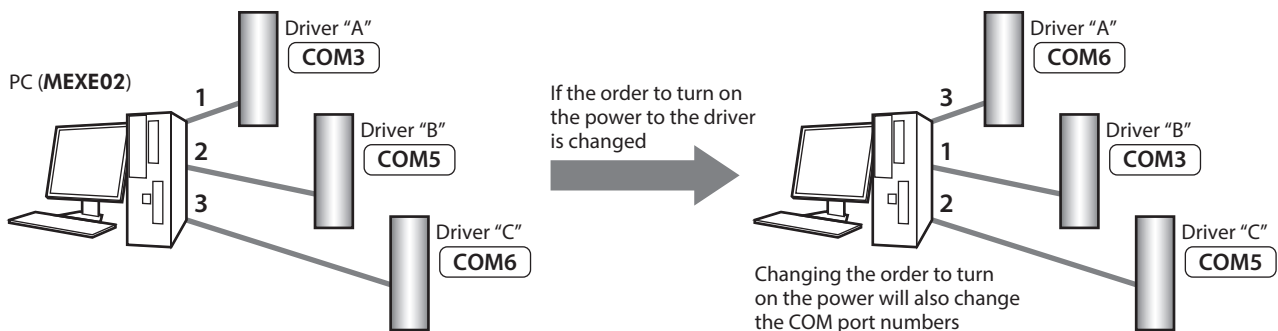

● When the USB-ID is set

If the "USB-ID" parameter is set, the same COM port numbers are always displayed regardless of the order of connection because the COM port number is fixed to each driver. (The USB-ID and the COM port number may not match because a PC associates with empty COM port numbers in descending order.)

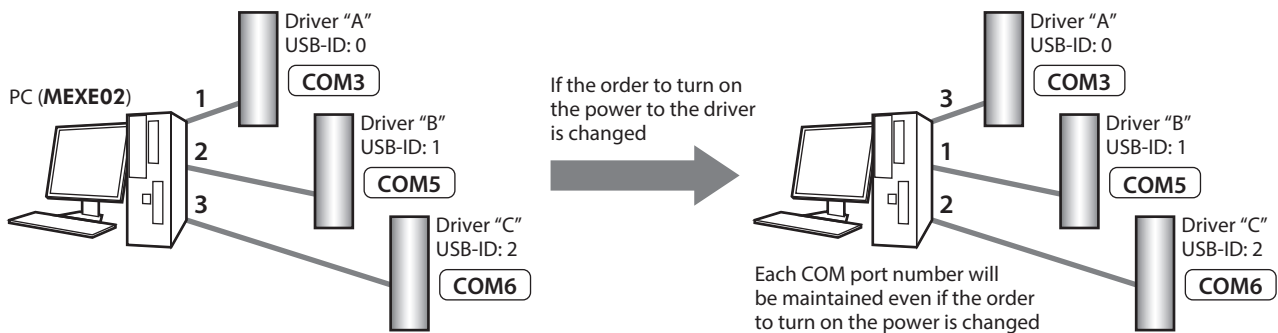

Note

The COM port number set with the "USB-ID" parameter is disabled if the PC is changed.

■ USB-PID

Although the USB-ID can fix the COM port number to each driver, changing the PC will also change and disable the COM port numbers.

Meanwhile, the USB-PID is a parameter to set an ID number to the driver itself. Even if the PC or the COM port number is changed, the product can easily be distinguished using the **MEXE02** because the ID number of the driver is not changed.

■ RS-485 Receive packet monitor

This is a parameter to select the target to be monitored with the RS-485 communication monitor of the **MEXE02**. Either "All" (entire communication) or "Only own address" can be selected.

■ Communication ID

This is a parameter to set the address number (slave address). The address number set with the address number setting switch is applied at the factory setting.

■ Baudrate

This is a parameter to set the Baudrate (transmission rate) according to the setting of the host controller. If the Baudrate is inconsistent with the host controller, communication is not established and a communication error occurs.

■ Communication order

This is a parameter to set the communication order according to the setting of the host controller. If the communication order is inconsistent with the host controller, communication is not established and a communication error occurs.

● Setting example

When data "1234 5678h" of 32-bit is stored in the register address 1000h and 1001h, the arrangement changes to the following according to the setting of the "Communication order" parameter.

Setting of parameters	1000h (even number address)		1001h (odd number address)	
	Upper	Lower	Upper	Lower
0: Even Address-High Word & Big-Endian	12h	34h	56h	78h
1: Even Address-Low Word & Big-Endian	56h	78h	12h	34h
2: Even Address-High Word & Little-Endian	34h	12h	78h	56h
3: Even Address-Low Word & Little-Endian	78h	56h	34h	12h



Data of RS-485 communication is described according to the order of "0: Even Address-High Word & Big-Endian" on this manual.

■ Communication parity

This is a parameter to set the communication parity according to the setting of the host controller. If the communication parity is inconsistent with the host controller, a parity error occurs.

■ Communication stop bit

This is a parameter to set the communication stop bit according to the setting of the host controller. If the communication stop bit is inconsistent with the host controller, a communication error occurs.

■ RS-485 communication timeout alarm

This is a parameter to set the condition in which the RS-485 communication communication timeout alarm is generated. If the time set in the parameter has elapsed and yet the communication is not established with the host controller, the RS-485 communication timeout alarm is generated. When RS-485 communication is performed properly, the monitoring time when communication has not established is reset (the time is also reset when the alarm is cleared).



The initial value of the "RS-485 communication timeout alarm" parameter is set to "0: Not monitored."

■ RS-485 communication error alarm

This is a parameter to set the condition in which the RS-485 communication error alarm is generated. If the RS-485 communication error such as mismatched CRC, parity error, or framing error occurs in succession and the number of occurred errors exceeds the number of times set in the parameter, the RS-485 communication error alarm is generated.



- When RS-485 communication is performed properly, the number of times of RS-485 communication error occurred is reset.
- To set the RS-485 communication error alarm to "Disable," set the value of the parameter to "0."

■ Transmission waiting time

This is a parameter to set the transmission waiting time. The transmission waiting time is a time after the slave switches its communication line to the transmission mode upon receiving a query from the master, until it starts sending a response (The actual transmission waiting time corresponds to the silent interval (C3.5) plus the value set in the "Transmission waiting time" parameter). If the value in the "Transmission waiting time" parameter is set to a shorter time than a time when the host controller switches to a receivable state, an error will occur in the host controller. Also, when a timeout, etc. is set in the host controller, an error will occur in the same way if the setting time is too long. Set according to the host controller.

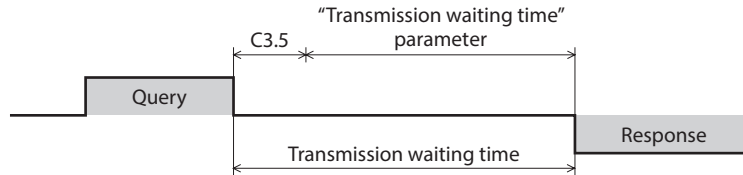

■ Silent interval

This is a parameter to set the silent interval. Be sure to provide an interval of 3.5 characters or more as the transmission waiting time for the silent interval. If this waiting time is less than 3.5 characters long, the driver cannot respond. When the "Silent interval" parameter is set to "0.0: Set automatically," the silent interval varies depending on the transmission rate.

● When the "Silent interval" parameter is set to "0.0: Set automatically"

Transmission rate (bps)	Silent interval	Frame interval of master (reference)
9,600	4.0 ms or more	5.0 ms or more
19,200 38,400 57,600 115,200 230,400	2.5 ms or more	3.0 ms or more

Note

- If frames are received at an interval shorter than the required silent interval, the frames are discarded and a communication error occurs. When a communication error occurs, check the silent interval of the slave and reset the frame transmission interval.
- The silent interval may vary depending on the product series connected. When connecting multiple product series, set parameters as follows.
 - "Silent interval" parameter: "0.0: Set automatically"
 - "Transmission waiting time" parameter: 1.0 ms or more
- In a system that the only products having the "Silent interval" parameter are connected, providing the common setting in the "Silent interval" parameter can improve the communication cycle. Use in a state of setting to "0.0: Set automatically" normally.

■ Slave error response mode

Sets the response when the slave error occurred. If the slave error occurs, an exception response is returned at the factory setting. When no exception response is required as in the case of a touch panel, set to "0: Normal response is returned".

● Exception response

An exception response is returned if the slave cannot execute the process requested by the query.

Appended to this response is an exception code indicating why the process cannot be executed. The message structure of exception response is as follows.

Slave address	Function code	Exception code	Error check
8 bits	8 bits	8 bits	16 bits

● Function code

The function code in the exception response is a sum of the function code in the query and 80h.

Function code of query	Exception response
03h	83h
06h	86h
08h	88h
10h	90h
17h	97h

● Exception code

The exception code when the slave error occurs is shown below.

Exception code	Communication error code	Description
04h	89h	Communication with user I/F is in progress (downloading or initializing in the MEXE02 is in progress).
	8Ah	Non-volatile memory processing is in progress. <ul style="list-style-type: none"> • Internal processing is in progress (S-BSY is ON). • An alarm of EEPROM error is present.
	8Ch	Outside the parameter setting range (the write value is outside the setting range).
	8Dh	Command execute disable

■ Initial group ID

The group send is a function that multiple slaves are made into a group and a query is sent to all slaves in the group at once. Set a group address (address number of parent slave) to the child slaves to be included in the group. However, the setting value of the "Group ID" command is saved in the RAM. In this case, if the power supply is turned off, the setting will be returned to the initial value and the group will be released. Therefore, the group is needed to set again every time after the power supply is turned on.

On the other hand, the "Initial group ID" parameter is stored in the non-volatile memory. If a group is set in this parameter, the group will not be released even when the power supply is turned off. The group function can be used immediately when the power supply is turned on.

■ Indirect reference address

The indirect reference address is a parameter to set an address of data that is desired to set by indirect reference (input a half value of the register address (upper) to be set).

Indirect reference is one of the setting method of a query. When addresses of data are not successive, multiple commands can be executed with one query by using indirect reference. Features of indirect reference are as follows.

Refer to p.87 for details.

- Indirect reference is a method in which data is stored in addresses exclusive for sending (indirect reference addresses) and set.
- Even if addresses of the data to be set are not successive, multiple data can be handled with one query because the indirect reference addresses are successive.
- The set data is operated by inputting the remote I/O.

Writing and reading the contents set in indirect reference are performed from the "Area" address of indirect reference via communication.

Modbus communication Register address		Name
Upper	Lower	
4928 (1340h)	4929 (1341h)	Indirect reference area (0)
4930 (1342h)	4931 (1343h)	Indirect reference area (1)
4932 (1344h)	4933 (1345h)	Indirect reference area (2)
4934 (1346h)	4935 (1347h)	Indirect reference area (3)
4936 (1348h)	4937 (1349h)	Indirect reference area (4)
4938 (134Ah)	4939 (134Bh)	Indirect reference area (5)
4940 (134Ch)	4941 (134Dh)	Indirect reference area (6)
4942 (134Eh)	4943 (134Fh)	Indirect reference area (7)
4944 (1350h)	4945 (1351h)	Indirect reference area (8)
4946 (1352h)	4947 (1353h)	Indirect reference area (9)
4948 (1354h)	4949 (1355h)	Indirect reference area (10)
4950 (1356h)	4951 (1357h)	Indirect reference area (11)
4952 (1358h)	4953 (1359h)	Indirect reference area (12)
4954 (135Ah)	4955 (135Bh)	Indirect reference area (13)
4956 (135Ch)	4957 (135Dh)	Indirect reference area (14)
4958 (135Eh)	4959 (135Fh)	Indirect reference area (15)

Modbus communication Register address		Name
Upper	Lower	
4960 (1360h)	4961 (1361h)	Indirect reference area (16)
4962 (1362h)	4963 (1363h)	Indirect reference area (17)
4964 (1364h)	4965 (1365h)	Indirect reference area (18)
4966 (1366h)	4967 (1367h)	Indirect reference area (19)
4968 (1368h)	4969 (1369h)	Indirect reference area (20)
4970 (136Ah)	4971 (136Bh)	Indirect reference area (21)
4972 (136Ch)	4973 (136Dh)	Indirect reference area (22)
4974 (136Eh)	4975 (136Fh)	Indirect reference area (23)
4976 (1370h)	4977 (1371h)	Indirect reference area (24)
4978 (1372h)	4979 (1373h)	Indirect reference area (25)
4980 (1374h)	4981 (1375h)	Indirect reference area (26)
4982 (1376h)	4983 (1377h)	Indirect reference area (27)
4984 (1378h)	4985 (1379h)	Indirect reference area (28)
4986 (137Ah)	4987 (137Bh)	Indirect reference area (29)
4988 (137Ch)	4989 (137Dh)	Indirect reference area (30)
4990 (137Eh)	4991 (137Fh)	Indirect reference area (31)

9.9 I/O signals assignment list

To assign signals via RS-485 communication, use the "Assignment number" in the table instead of the signal names.

■ Input signal

Assignment number	Signal name
0	Not used
8	ALM-RST
14	INFO-CLR
16	HMI
22	TL
25	EXT-ERROR*1

Assignment number	Signal name
58	FWD (START/STOP)*2
59	REV (RUN/BRAKE)*2
64	M0
65	M1
66	M2
72	STOP-MODE (FWD/REV)*2
74	H-FREE

Assignment number	Signal name
80	R0
81	R1
82	R2
83	R3

*1 The EXT-ERROR input cannot be assigned to the remote input.

*2 If the 3-wire mode is selected with the "Operation input mode selection" parameter, the signal in the parentheses () will be applied.

■ Output signal

Assignment number	Signal name
0	Not used
8	ALM-RST_R
14	INFO-CLR_R
16	HMI_R
22	TL_R
25	EXT-ERROR_R
58	FWD (START/STOP)_R*1
59	REV (RUN/BRAKE)_R*1
64	M0_R
65	M1_R
66	M2_R
72	STOP-MODE (FWD/REV)_R*1
74	H-FREE_R
80	R0_R
81	R1_R
82	R2_R
83	R3_R

Assignment number	Signal name
129	ALM-A
130	ALM-B
134	MOVE
135	INFO
136	SYS-BSY
140	TLC
141	VA
147	SPEED-OUT*2
148	DIR
168	MPS

Assignment number	Signal name
226	INFO-DRVTMP
228	INFO-OVOLT
229	INFO-UVOLT
231	INFO-LOAD
232	INFO-SPD
233	INFO-SET-E
236	INFO-DRV
239	INFO-NET-E
243	INFO-REV
244	INFO-TRIP
245	INFO-ODO
248	INFO-TRQ-DE
249	INFO-SPD-DE
250	INFO-PTIME
251	INFO-PCOUNT
252	INFO-DSLMTD
253	INFO-IOTEST
254	INFO-CFG
255	INFO-RBT

*1 If the 3-wire mode is selected with the "Operation input mode selection" parameter, the signal in the parentheses () will be applied.

*2 The SPEED-OUT output cannot be assigned to the remote output. Also, the logic level setting cannot be inverted.

10 I/O signals

This manual describes I/O signals as follows.

- Direct I/O: I/O to be accessed via I/O signal connector (CN2)
- Remote I/O: I/O to be accessed via RS-485 communication

10.1 Direct I/O

Direct I/O is I/O that the I/O signal cable is connected to the I/O signal connector (CN2) to input and output signals directly.

■ Assignment to the input terminals

The following signals are assigned at the time of shipment. Input signals and logic level settings assigned to the direct inputs D-IN0 to D-IN4 can be changed using parameters.

Refer to p.61 for the input signals list that can be assigned.

Terminal name	Factory setting
D-IN0	FWD (START/STOP)*
D-IN1	REV (RUN/BRAKE)*
D-IN2	STOP-MODE (FWD/REV)*
D-IN3	M0
D-IN4	ALM-RST

* If the 3-wire mode is selected with the "Operation input mode selection" parameter, the signal in the parentheses () will be applied.

Related parameters

Parameter name	Description	Factory setting
D-IN0 input function selection	Selects the input signal to assign to the direct input (D-IN0 to D-IN4).	58: FWD (START/STOP)*
D-IN1 input function selection		59: REV (RUN/BRAKE)*
D-IN2 input function selection		72: STOP-MODE (FWD/REV)*
D-IN3 input function selection		64: M0
D-IN4 input function selection		8: ALM-RST

* If the 3-wire mode is selected with the "Operation input mode selection" parameter, the signal in the parentheses () will be applied.



- When the same input signal is assigned to multiple input terminals, the function will be executed if any one of the terminals is turned ON.
(Except for HMI input, TL input, and EXT-ERROR input)
- For the HMI input, the TL input, and the EXT-ERROR input, they are always being ON if not assigned.
If these signals are assigned to both direct I/O and remote I/O or to multiple terminals, the function will be enabled when all terminals are turned ON.
- For the direct input, in order to surely recognize the input signal, ensure the ON time and OFF time of each input signal for at least 2 ms.

■ Changing the logic level setting of input signals

The logic level setting for the direct input can be changed.

Parameter	Description	Setting range	Factory setting
D-IN0 input logic level setting to D-IN4 input logic level setting	Changes the logic level setting for the direct input (D-IN0 to D-IN4).	0: Not invert 1: Invert	0

In the case of the factory setting (setting is "Not invert"), the driver recognizes that an internal signal is ON (active state) when the direct input is "L level."

If the parameter setting is changed to "Invert," the driver recognizes that an internal signal is ON (active state) when the direct input is "H level."

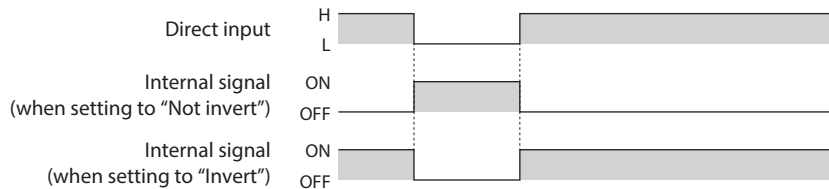

■ Assignment to the output terminals

The following signals are assigned at the time of shipment. Output signals and logic level settings assigned to the direct outputs D-OUT0 and D-OUT1 can be changed using parameters.

Refer to p.62 for the output signals list that can be assigned.

Terminal name	Factory setting
D-OUT0	SPEED-OUT
D-OUT1	ALM-B

Related parameters

Parameter name	Description	Factory setting
D-OUT0 output function selection	Selects the output signal to assign to the direct output (D-OUT0, D-OUT1).	147: SPEED-OUT
D-OUT1 output function selection		130: ALM-B

■ Changing the logic level setting of output signals

The logic level setting for direct output can be changed.

Parameter	Description	Setting range	Factory setting
D-OUT0 output logic level setting D-OUT1 output logic level setting	Changes the logic level setting for the direct output (D-OUT0, D-OUT1).	0: Not invert 1: Invert	0

In the case of the factory setting (setting is "Not invert"), the internal transistor is in an "energized state" when an internal signal is turned ON (active state).

If the parameter setting is changed to "Invert," the internal transistor is in an "energized state" when an internal signal is OFF (active state).

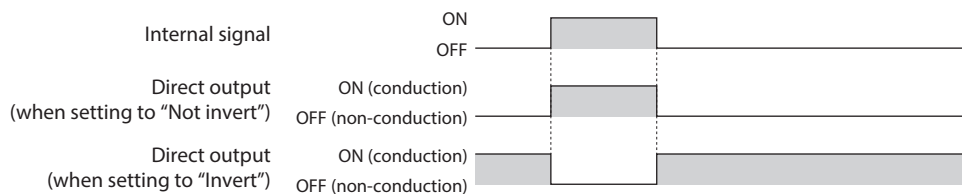

Changing the logic level setting is not available for the SPEED-OUT output.

Even if the logic level setting of D-OUT that the SPEED-OUT output is assigned is changed to "Invert," an energized state of the internal transistor does not change.

10.2 Remote I/O

Remote I/O is I/O to be accessed via RS-485 communication.

■ Assignment to input signals

The following signals are assigned at the time of shipment. Input signals assigned to the remote inputs R-IN0 to R-IN15 can be changed using parameters. Refer to p.61 for the input signals list that can be assigned.

Remote I/O signal name	Factory setting	Remote I/O signal name	Factory setting
R-IN0	M0	R-IN8	Not used
R-IN1	M1	R-IN9	Not used
R-IN2	M2	R-IN10	Not used
R-IN3	FWD (START/STOP)*	R-IN11	Not used
R-IN4	REV (RUN/BRAKE)*	R-IN12	Not used
R-IN5	STOP-MODE (FWD/REV)*	R-IN13	Not used
R-IN6	Not used	R-IN14	Not used
R-IN7	ALM-RST	R-IN15	Not used

* If the 3-wire mode is selected with the "Operation input mode selection" parameter, the signal in the parentheses () will be applied.

Related parameters

Parameter name	Description	Factory setting
R-IN0 input function selection	Selects the input signal to assign to the remote input (R-IN0 to R-IN15).	64: M0
R-IN1 input function selection		65: M1
R-IN2 input function selection		66: M2
R-IN3 input function selection		58: FWD (START/STOP)*
R-IN4 input function selection		59: REV (RUN/BRAKE)*
R-IN5 input function selection		72: STOP-MODE (FWD/REV)*
R-IN6 input function selection		0: Not used
R-IN7 input function selection		8: ALM-RST
R-IN8 input function selection		0: Not used
R-IN9 input function selection		0: Not used
R-IN10 input function selection		0: Not used
R-IN11 input function selection		0: Not used
R-IN12 input function selection		0: Not used
R-IN13 input function selection		0: Not used
R-IN14 input function selection		0: Not used
R-IN15 input function selection		0: Not used

* If the 3-wire mode is selected with the "Operation input mode selection" parameter, the signal in the parentheses () will be applied.



- When the same input signal is assigned to multiple input terminals, the function will be executed if any one of the terminals is turned ON. (Except for HMI input and TL input)
- For the HMI input and the TL input, they are always being ON if not assigned.
If these signals are assigned to both direct I/O and remote I/O or to multiple terminals, the function will be enabled when all terminals are turned ON.

■ Assignment of output signals

The following signals are assigned at the time of shipment. Output signals assigned to the remote outputs R-OUT0 to R-OUT15 can be changed using parameters. Refer to p.62 for the output signals list that can be assigned.

Remote I/O signal name	Factory setting	Remote I/O signal name	Factory setting
R-OUT0	M0_R	R-OUT8	SYS-BSY
R-OUT1	M1_R	R-OUT9	DIR
R-OUT2	M2_R	R-OUT10	MPS
R-OUT3	FWD (START/STOP)_R*	R-OUT11	Not used
R-OUT4	REV (RUN/BRAKE)_R*	R-OUT12	Not used
R-OUT5	STOP-MODE (FWD/REV)_R*	R-OUT13	MOVE
R-OUT6	INFO	R-OUT14	VA
R-OUT7	ALM-A	R-OUT15	TLC

* If the 3-wire mode is selected with the "Operation input mode selection" parameter, the signal in the parentheses () will be applied.

Related parameters

Parameter name	Description	Factory setting
R-OUT0 output function selection	Selects the output signal to assign to the remote output (R-OUT0 to R-OUT15).	64: M0_R
R-OUT1 output function selection		65: M1_R
R-OUT2 output function selection		66: M2_R
R-OUT3 output function selection		58: FWD (START/STOP)_R*
R-OUT4 output function selection		59: REV (RUN/BRAKE)_R*
R-OUT5 output function selection		72: STOP-MODE (FWD/REV)_R*
R-OUT6 output function selection		135: INFO
R-OUT7 output function selection		129: ALM-A
R-OUT8 output function selection		136: SYS-BSY
R-OUT9 output function selection		148: DIR
R-OUT10 output function selection		168: MPS
R-OUT11 output function selection		0: Not used
R-OUT12 output function selection		0: Not used
R-OUT13 output function selection		134: MOVE
R-OUT14 output function selection		141: VA
R-OUT15 output function selection		140: TLC

* If the 3-wire mode is selected with the "Operation input mode selection" parameter, the signal in the parentheses () will be applied.

10.3 Signals list

■ Input signals

Assignment number	Signal name	Description
0	Not used	Set when the input terminal is not used.
8	ALM-RST	This is a signal to reset the alarm being generated. (The signal is reset at the ON edge of the input.)
14	INFO-CLR	This is a signal to clear the information being generated. (The signal is reset at the ON edge of the input.)
16	HMI*1	This is a signal to switch whether to enable or disable the function limitation of the MEXE02 . (The function limitation is released when this signal is turned ON.)
22	TL*1	This is a signal to switch whether to enable or disable the torque limiting function. (The torque limiting function is enabled when this signal is turned ON.)
25	EXT-ERROR*2	This is a signal to generate the external stop alarm and stop the motor forcibly. (The alarm is generated when this signal is turned OFF.)
58	FWD (START/STOP)*3	This is a signal to rotate or stop the motor. (The motor rotates when this signal is turned ON.)
59	REV (RUN/BRAKE)*3	The function and name vary depending on the setting of the "Operation input mode selection" parameter.
64	M0	These are signals to select the operation data number.
65	M1	
66	M2	
72	STOP-MODE (FWD/REV)*3	This is a signal to set the motor movement. The function and name will change by the setting of the "Operation input mode selection" parameter. <div style="border: 1px solid black; padding: 5px; width: fit-content;"> STOP-MODE: This is a signal to select how to stop the motor. (OFF: Deceleration stop, ON: Instantaneous stop) FWD/REV: This is a signal to select the motor rotation direction. (OFF: Reverse direction, ON: Forward direction) </div>
74	H-FREE	This is the input signal that can be used when the load holding function is enabled. If the H-FREE input is turned ON when the stopped motor shaft is electrically held by the load holding function, the motor shaft can be rotated by an external force (free-run state).
80	R0	These are general signals.
81	R1	
82	R2	
83	R3	

*1 A state of an internal signal is always ON (active state) if it is not assigned to the direct input and remote input.

*2 The EXT-ERROR input is not available to the assignment of the remote input. A state of an internal signal is always ON (active state) if the EXT-ERROR input is not assigned.

*3 If the 3-wire mode is selected with the "Operation input mode selection" parameter, the signal in the parentheses () will be applied.

■ Output signals

Assignment number	Signal name	Description
0	Not used	Set when the output terminal is not used.
8	ALM-RST_R	These are signals to output a response to an input signal.
14	INFO-CLR_R	
16	HMI_R	
22	TL_R	
25	EXT-ERROR_R	
58	FWD (START/STOP)_R*1	
59	REV (RUN/BRAKE)_R*1	
64	M0_R	
65	M1_R	
66	M2_R	
72	STOP-MODE (FWD/REV)_R*1	
74	H-FREE_R	
80	R0_R	
81	R1_R	
82	R2_R	
83	R3_R	
129	ALM-A	This is a signal to output an alarm status of the driver. It is turned ON when an alarm is generated.
130	ALM-B	This is a signal to output an alarm status of the driver. It is turned OFF when an alarm is generated.
134	MOVE	This is a signal to output the operating status of the motor. It is turned ON when the motor is operated by the operation input signal.
135	INFO	This is a signal to output an information status of the driver. It is turned ON when information is generated.
136	SYS-BSY	This is a signal to output when the driver is in an internal processing state. It is turned ON when the internal processing is being performed.
140	TLC	This is a signal to output when the output torque reaches the torque limiting value having set. It is turned ON when the output torque reaches the limit value and is limited.
141	VA	This is a signal to output when the motor feedback speed reaches the setting speed. It is turned ON when the feedback speed reaches the plus or minus range of VA detection width with respect to the setting speed.
147	SPEED-OUT*2	This is a signal to output in synchronization with the motor rotation. 30 pulses are output with each revolution of the motor output shaft.
148	DIR	This is a signal to output information of the motor rotation direction. It is turned ON when the motor shaft rotates in the forward direction.
168	MPS	This is a signal to output the power-on status of the main power supply. It is turned ON when the main power supply is turned on.

*1 If the 3-wire mode is selected with the "Operation input mode selection" parameter, the signal in the parentheses () will be applied.

*2 Changing the logic level setting is not available for the SPEED-OUT output. Also, the SPEED-OUT output cannot be assigned to the remote output.

Assignment number	Signal name	Description
226	INFO-DRVTMP	These are signals to output when the corresponding information is generated.
228	INFO-OVOLT	
229	INFO-UVOLT	
231	INFO-LOAD	
232	INFO-SPD	
233	INFO-SET-E	
236	INFO-DRV	
239	INFO-NET-E	
243	INFO-REV	
244	INFO-TRIP	
245	INFO-ODO	
248	INFO-TRQ-DE	
249	INFO-SPD-DE	
250	INFO-PTIME	
251	INFO-PCOUNT	
252	INFO-DSLMTD	
253	INFO-IOTEST	
254	INFO-CFG	
255	INFO-RBT	

10.4 Input signals

This section explains each input signal.



When input signals are assigned to the direct input, in order to surely recognize the input signal, ensure the ON time and OFF time of each input signal for at least 2 ms.

Names and functions of the operation input signals vary depending on the setting of the "Operation input mode selection" parameter.

Operation input signals 3-Wire mode: START/STOP input, RUN/BRAKE input, FWD/REV input
 2-Wire mode: FWD input, REV input, STOP-MODE input

[3-Wire mode]

■ START/STOP input, RUN/BRAKE input

The motor rotates according to the acceleration time when both the START/STOP input and the RUN/BRAKE input are turned ON.

If the START/STOP input is turned OFF while the motor rotates, the motor decelerates to a stop * according to the deceleration time.

If the RUN/BRAKE input is turned OFF while the motor rotates, the motor stops at the shortest time (instantaneous stop).

* Operation of deceleration stop can be changed by setting of the "Deceleration mode selection" parameter. (p.40)



- When the START/STOP input and the RUN/BRAKE input are turned OFF simultaneously, the RUN/BRAKE input is prioritized.
- The actual acceleration time and deceleration time are affected by customer's conditions of use, load inertia, and load torque.

■ FWD/REV input

This is a signal to change the motor rotation direction.

The motor rotates in the forward direction when this signal is turned ON, and in the reverse direction when it is turned OFF.



The rotation direction of the motor varies depending on the setting of the "Motor rotation direction" parameter or the gear ratio of the gearhead.

Example:

When the "Motor rotation direction" parameter is set to "positive direction (+) = CW" (factory setting)

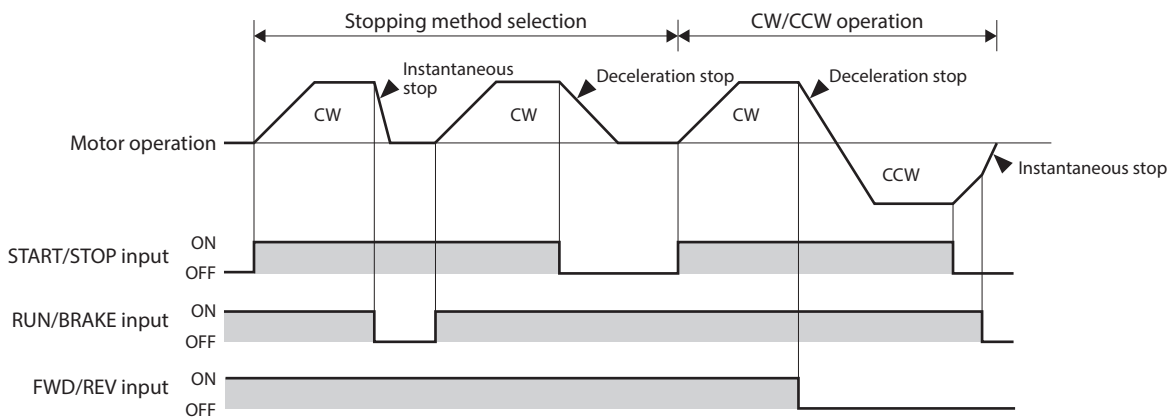

[2-Wire mode]

■ FWD input, REV input

When the FWD input is turned ON, the motor rotates in the forward direction. When it is turned OFF, the motor stops according to the STOP-MODE input status.

When the REV input is turned ON, the motor rotates in the reverse direction. When it is turned OFF, the motor stops according to the STOP-MODE input status.

If the FWD input and the REV input are turned ON simultaneously during motor rotation, the motor decelerates to a stop.



If the STOP-MODE input status is changed from OFF to ON while the motor decelerates to a stop, the motor operation changes to instantaneous stop.

■ STOP-MODE input

This is a signal to select how the motor should stop when the FWD input or the REV input is turned OFF.

When the STOP-MODE input is OFF, the motor decelerates to a stop according to the deceleration time of the operation data number.

When the STOP-MODE input is ON, the motor stops at the shortest time (instantaneous stop).

Example:

When the "Motor rotation direction" parameter is set to "positive direction (+) = CW" (factory setting)

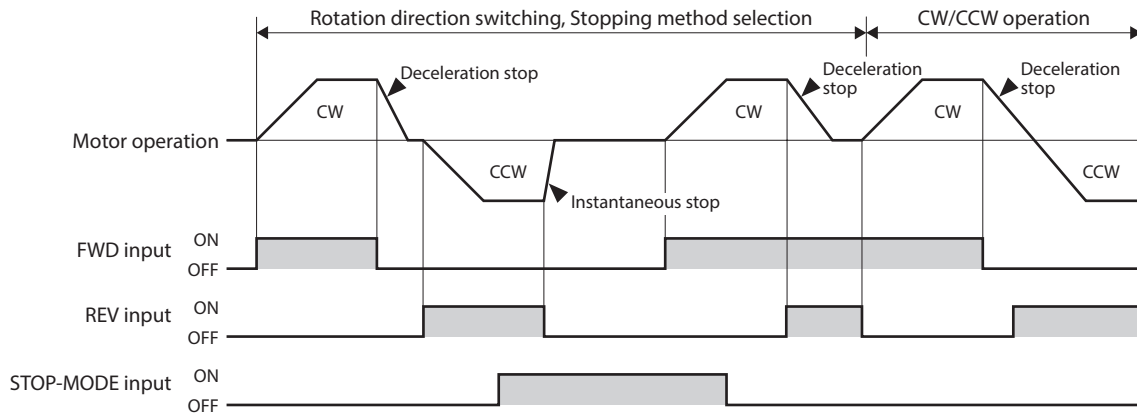

■ M0 to M2 inputs

Desired operation data number can be selected by a combination of ON-OFF status of the M0 to M2 inputs.

The number of selectable operation data is eight data.

Variable speed operation and multi-speed operation can be performed.

Operation data number	M2	M1	M0
0	OFF	OFF	OFF
1	OFF	OFF	ON
2	OFF	ON	OFF
3	OFF	ON	ON
4	ON	OFF	OFF
5	ON	OFF	ON
6	ON	ON	OFF
7	ON	ON	ON

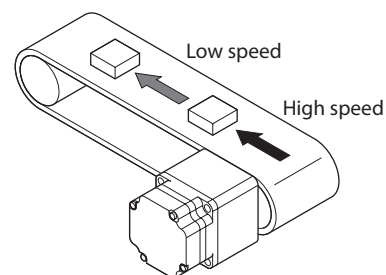

■ ALM-RST input

The ALM-RST input is a signal to reset an alarm status. (The alarm will be reset at the ON edge of the input.)

To reset an alarm, turn the operation input signal OFF, and remove the cause of the alarm before turning the ALM-RST input ON. In the case of the 3-wire mode, when both the START/STOP input and RUN/BRAKE input are being ON, the ALM-RST input is disabled. (In the case of the 2-wire mode, when either the FWD input or the REV input is being ON, the ALM-RST input is disabled.) If an alarm cannot be reset with the ALM-RST input, once turned off the power supply and turn on again.

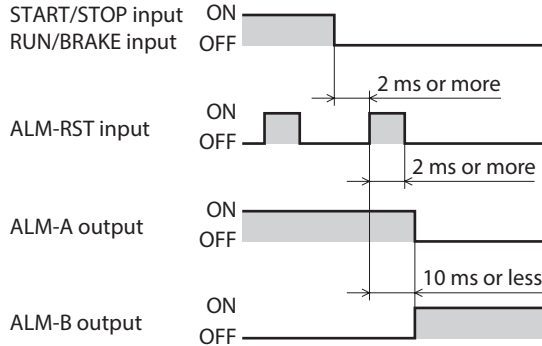

* If an alarm is generated while the motor rotates, the motor will stop. The stopping method varies depending on the alarm type.



- Continuing the operation without removing the cause of the alarm may cause damage to equipment.
- Alarms of overcurrent, EEPROM error, and CPU error cannot be reset with the ALM-RST input.

■ INFO-CLR input

The INFO-CLR input is a signal to clear an information status. (Information will be cleared at the ON edge of the input.)

This signal is used when the "INFO auto clear" parameter is set to disable. If it is turned from OFF to ON while information is being generated, the information status will be cleared.

Related parameters

Parameter name	Description	Setting range	Factory setting
INFO auto clear	This is a function to clear the information status automatically when the cause of the generated information was removed.	0: Disable 1: Enable	1

■ HMI input

The HMI input is a signal to release the function limitation of the **MEXE02**.

When the HMI input is turned ON, the function limitation of the **MEXE02** is released.

When the HMI input is turned OFF, the function limitation is imposed.

[Functions to be limited]

- Writing of operation data and parameters
- I/O test
- Teaching/remote operation
- Clearing of records and others
- Configuration
- Initialization (restores to the factory setting)



Even if the function limitation of the **MEXE02** is imposed by the HMI input, it can be released by executing "HMI release" such as inputting the key code using the **MEXE02** or RS-485 communication.



- The HMI input is always ON (active state) as an internal signal if it is not assigned to the direct input or the remote input. When this signal is in an ON state (active state), the function limitation of the **MEXE02** is not imposed (the HMI input is not assigned at the time of shipment).
- If the HMI input is assigned to both the direct input and the remote input or to multiple terminals, when all assigned input terminals are turned ON, it is in an ON state (active state) as an internal signal and the function limitation is released.

■ TL input

The TL input is a signal to switch whether to enable or disable the torque limiting function.

When the TL input is turned ON, the torque limiting function is enabled.

The maximum value of the motor output torque is limited based on the set torque limiting value.

When the TL input is turned OFF, the torque limiting function is disabled, and the maximum value of the motor output torque will be the peak torque (200%).

Note

- The TL input is always ON (active state) as an internal signal if it is not assigned to the direct input or remote input. When this signal is in an ON state (active state), the torque limiting function is enabled (the TL input is not assigned at the time of shipment).
- If the TL input is assigned to both the direct input and the remote input or to multiple terminals, when all assigned input terminals are turned ON, it is in an ON state (active state) as an internal signal.

■ EXT-ERROR input

The EXT-ERROR input is a signal for emergency stop.

When this signal is turned OFF, an alarm is generated to stop the motor instantaneously.

Note

- The EXT-ERROR input is always ON (active state) as an internal signal if it is not assigned to the direct input. When this signal is in an ON state (active state), the external stop alarm is not generated (the EXT-ERROR input is not assigned at the time of shipment).
- If the EXT-ERROR input is assigned to multiple direct input terminals, when all assigned input terminals are turned ON, it is in an ON state (active state) as an internal signal.
- The EXT-ERROR input cannot be assigned to the remote input.

■ H-FREE input

This is the input signal that can be used when the load holding function is enabled.

If the H-FREE input is turned ON when the stopped motor shaft is electrically held by the load holding function, the motor shaft can be rotated by an external force (free-run state).

10.5 Output signals

■ SPEED-OUT output

30 pulses are output while the motor output shaft makes one revolution in synchronization with the motor rotation. The pulse width of output pulse signals is 0.2 ms. The motor rotation speed can be calculated using the SPEED-OUT output.

$$\text{Frequency of SPEED-OUT (Hz)} = \frac{1}{T}$$

$$\text{Rotation speed (r/min)} = \frac{\text{Frequency of SPEED-OUT}}{30} \times 60$$

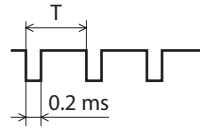

Note

- Changing the logic level setting is not available for the SPEED-OUT output.
- The SPEED-OUT output cannot be assigned to the remote output.
- The SPEED-OUT output repeats a state of ON or OFF. The SPEED-OUT output may be in a state of OFF depending on the acquisition timing by the **MEXE02** or RS-485 communication even if the SPEED-OUT output (ON-OFF) is activated.

■ ALM-A output, ALM-B output

This is a signal to output the status of alarm generation. If an alarm is generated, the ALM-A output is turned ON (in the case of normally open), and the ALM-B output is turned OFF (in the case of normally closed).

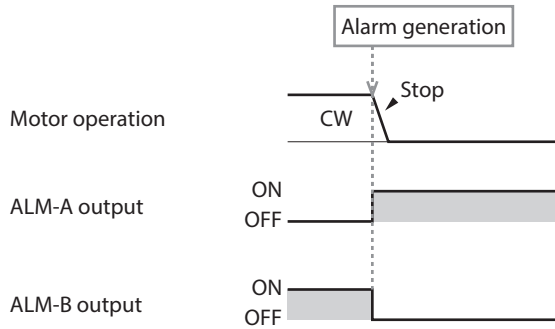

■ TLC output

When the motor output torque is limited, the TLC output is turned ON.

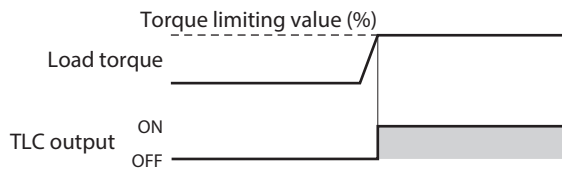

Note

If the motor is operated at low speed or the torque limiting value is set to less than 20%, the TLC output may not be stable.

■ DIR output

This is a signal to output information of the motor rotation direction.

It is turned ON when the motor rotates in the forward direction, and OFF when in the reverse direction.

The previous output state will be continued until the motor will reversely rotate next time. The DIR output immediately after the power is turned on will be OFF.



Since this signal is output based on the actual rotation direction of the motor, it is output even if the operation input signal is an OFF state or the motor is externally driven forcibly.

Related parameters

Parameter name	Description	Setting range	Factory setting
Motor rotation direction	Sets the motor rotation direction. (Sets the rotation direction when turning the FWD input ON if the "2-wire mode" is selected with the "Operation input mode selection" parameter. Sets the rotation direction when turning the FWD/REV input ON if the "3-wire mode" is selected.)	0: Positive direction (+)=CCW 1: Positive direction (+)=CW	1

Example: When the "Motor rotation direction" parameter is set to "positive direction (+)=CW"

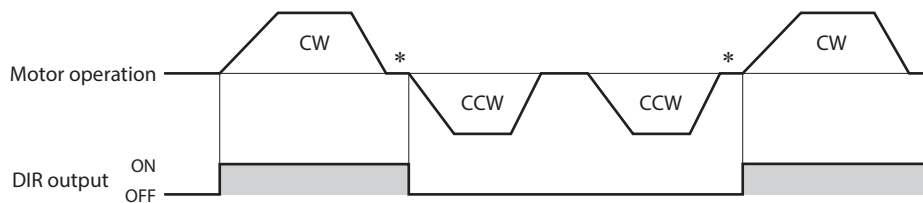

* A state just before stopping is output while the motor stops.

■ MOVE output

The MOVE output is turned ON when the motor is rotating by turning the operation input signal ON.

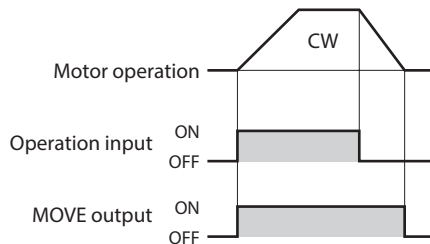

■ INFO output

This is a signal to check the status of information generation. If any one of information is generated, the INFO output will be turned ON.

However, if information that a parameter of INFO action is set to "Not applied" is generated, the INFO output will not be turned ON.

■ VA output

When the feedback speed reached the "plus or minus range of VA detection width with respect to the setting speed," this output is turned ON.

A range to turn the VA output ON can be set using the "VA detection width" parameter.

Related parameters

Parameter name	Description	Setting range	Factory setting
VA detection width	Sets the detection width for the VA output.	1 to 400 r/min]	200

Example: When the motor speed changes from the setting speed 1 to the setting speed 2

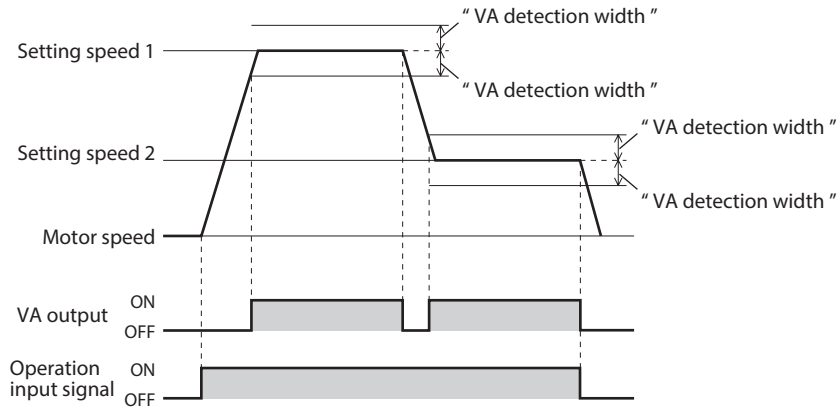

■ Information bit output

If corresponding information is generated, each output signal is turned ON.

Information	Information bit output signal
Driver temperature	INFO-DRVTMP
Overvoltage	INFO-OVOLT
Undervoltage	INFO-UVOLT
Load	INFO-LOAD
Speed	INFO-SPD
Operation data setting error	INFO-SET-E
Operation prohibited	INFO-DRV
RS-485 communication error	INFO-NET-E
Rotation amount meter	INFO-REV
Tripmeter	INFO-TRIP

Information	Information bit output signal
Odometer	INFO-ODO
Torque limiting value setting error	INFO-TRQ-DE
Rotation speed setting error	INFO-SPD-DE
Main power supply time	INFO-PTIME
Main power supply count	INFO-PCOUNT
Operation start limit mode	INFO-DSLMTD
I/O test mode	INFO-IOTEST
Configuration request	INFO-CFG
Power cycling request	INFO-RBT

■ SYS-BSY output

This signal is turned ON in the following conditions.

- When the maintenance command is executed via RS-485 communication
- When Configuration, teaching/remote operation, or I/O test is being executed with the **MEXE02**
- When writing of operation data or parameters is being executed with the **MEXE02**

Rewriting of the operation data or executing the maintenance command are not allowed in a state where the SYS-BSY output is being ON.

■ MPS output

The MPS output is turned ON when the main power supply is turned on.

■ Response output

The response output is a signal to output the ON-OFF status of the corresponding input signal. The table below shows the correspondences between input signals and output signals.

Input signals	Output signals
ALM-RST	ALM-RST_R
INFO-CLR	INFO-CLR_R
HMI	HMI_R
TL	TL_R
EXT-ERROR	EXT-ERROR_R
FWD (START/STOP)	FWD (START/STOP)_R
REV (RUN/BRAKE)	REV (RUN/BRAKE)_R
M0	M0_R
M1	M1_R
M2	M2_R
STOP-MODE (FWD/REV)	STOP-MODE (FWD/REV)_R
H-FREE	H-FREE_R
R0	R0_R
R1	R1_R
R2	R2_R
R3	R3_R

10.6 General signals

The R0 to R3 inputs are general signals. Using the R0 to R3 inputs, the I/O signals of the external device can be controlled via the driver from the host controller. The direct I/O of the driver can be used as an I/O module.

■ Example of use for general signals

● When signals are output from the host controller to the external device

Assigns the R0 input to the D-OUT0 output and the R-IN0.

The D-OUT0 output is turned ON when the R-IN0 is set to 1, and the D-OUT0 output is turned OFF when the R-IN0 is set to 0.

● When outputs of the external device is input to the host controller

Assigns the R1 to the D-IN1 input and R-OUT1.

The R-OUT1 output is set to 1 when the D-IN1 input is turned ON from the external device, and the R-OUT1 output is set to 0 when the D-IN1 input is turned OFF. The logic level of the input can be set with the "D-IN1 input logic level setting" parameter.

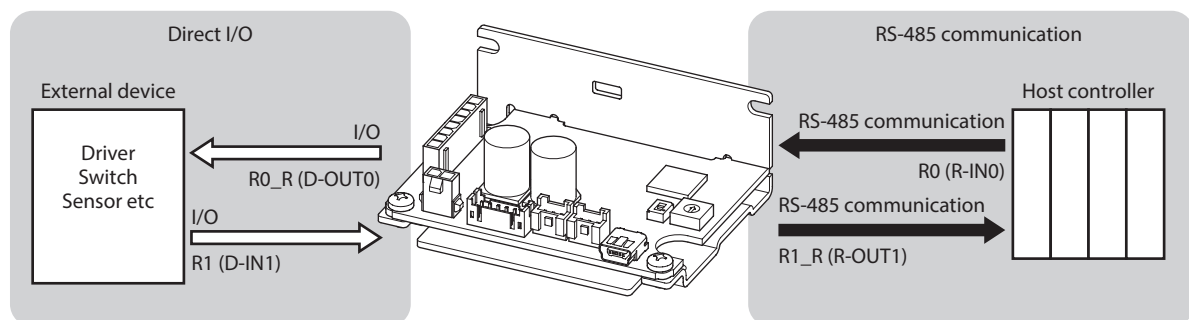

11 Modbus RTU control (RS-485 communication)

This chapter describes how to control from the host controller via RS-485 communication. The protocol used in RS-485 communication is the Modbus protocol.

11.1 Modbus RTU specifications

The Modbus protocol is simple to use and its specification is open to the public, so this protocol is widely used in industrial applications.

Modbus communication is based on the single-master/multiple-slave method. Only the master can issue a query (command).

Each slave executes the process requested by query and returns a response message.

The **BLH** Series RS-485 communication type supports the RTU mode only as the transmission mode. The ASC II mode is not supported. Under this protocol, messages are sent in one of two methods.

- **Unicast mode**

The master sends a query to only one slave. The slave executes the process and returns a response.

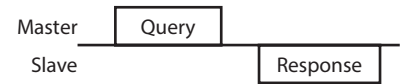

- **Broadcast mode**

If slave address 0 is specified on the master, the master can send a command to all slaves. Each slave executes the process, but does not return a response.

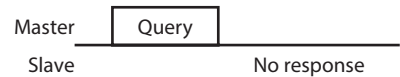

11.1.1 Communication specifications

Electrical characteristics	In conformance with EIA-485 Use a twisted pair cable and keep the total extension distance of the communication cable up to 10 m (32.8 ft.). *
Communication mode	Half duplex Asynchronous mode (data: 8 bits, stop bit: 1 bit/2 bits, parity: none/even number/odd number)
Transmission rate	Selectable from 9,600 bps, 19,200 bps, 38,400 bps, 57,600 bps, 115,200 bps, and 230,400 bps.
Protocol	Modbus RTU mode
Type of Connection	Up to 15 drivers can be connected to one programmable controller (master device).

* If the motor cable or the power supply cable generates an undesirable amount of noise depending on the wiring or configuration, shield the cable or install a ferrite core.

■ Connection diagram

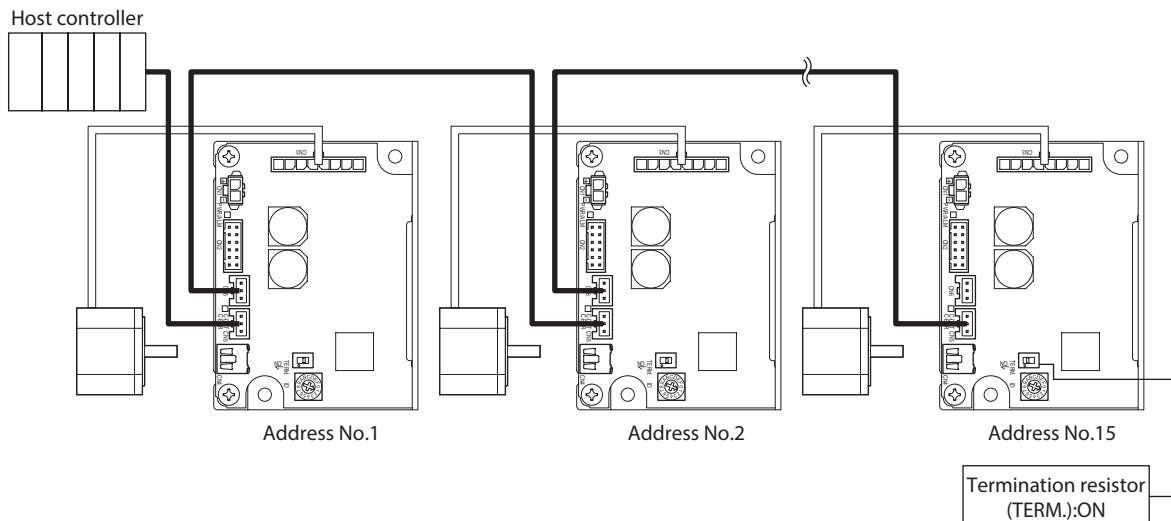

● Internal input circuit

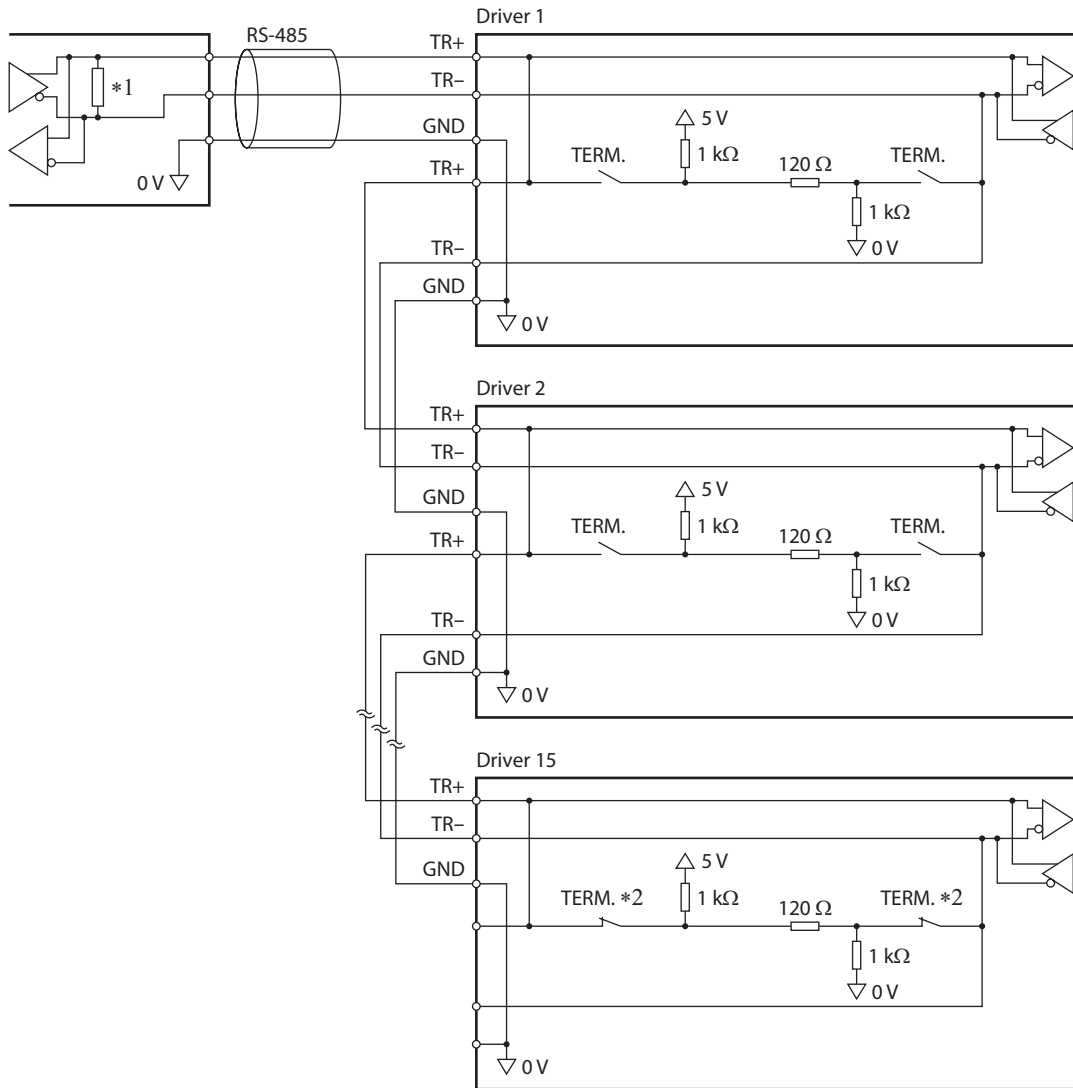

- *1 Termination resistor 120 Ω
- *2 Turn the termination resistor ON.

11.1.2 Communication timing

The communication time monitored by the driver and the communication timing of the master are as follows.

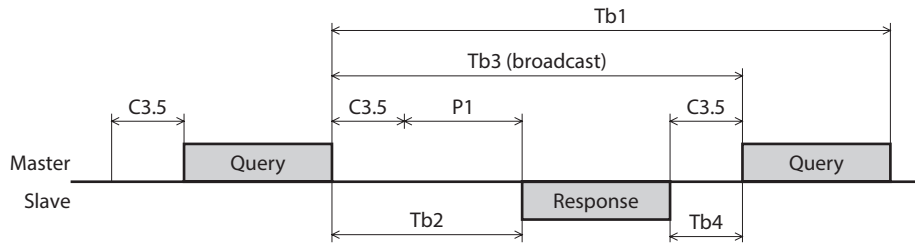

Code	Name	Description
Tb1	Communication timeout	Intervals between received queries are monitored. If no query could be received after the time set with the "RS-485 communication timeout alarm" parameter, an alarm of the communication timeout is generated. [Initial value: 0 (Not monitored)] When normal messages including messages to other slaves were received, the communication timeout does not occur.
Tb2	Transmission waiting time	This is the time after receiving a query from the master until it starts sending a response. The transmission waiting time corresponds to the silent interval (C3.5) plus the value set in the "Transmission waiting time" parameter (P1). After the master sent a query, if the transmission waiting time is shorter than the time to switch to the reception status, adjust with the "Transmission waiting time" parameter (P1). (Initial value: 3.0 ms)
Tb3	Broadcasting interval	This is the time until the next query is sent in broadcasting. A time equivalent to or longer than the silent interval (C3.5) plus 5 ms is required.
C3.5	Silent interval	This is the time after sending a response until switching to the reception status or after receiving a query until switching to the transmission status. * It can be changed with the "Silent interval" parameter, but be sure to set the silent interval that is longer than the time to send 3.5 characters. [Initial value: 0.0 (Set automatically)] When the "Silent interval" parameter is set to "0.0: Set automatically," the silent interval varies depending on the transmission rate. Refer to the following table for details.
Tb4	Transmission waiting time (master side)	This is the time after the master received a response until it send the next query (setting in the master side). Set so that it is equal to or longer than the time set with the "Silent interval" parameter. Setting the "Silent interval" parameter to "0.0: Set automatically" will be frame transmission intervals (reference) of the master shown in the table below.

* For the time after receiving a query until sending a response, the time for the "Transmission waiting time" parameter (P1) is added.

■ When the "Silent interval" parameter is set to "0.0: Set automatically"

Transmission rate (bps)	Silent interval	Frame interval of the master (reference)*
9,600	4.0 ms or more	5.0 ms or more
19,200 38,400 57,600 115,200 230,400	2.5 ms or more	3.0 ms or more

* The driver can receive a query certainly by setting the frame transmission intervals of the master (the time after receiving a response until sending) to the reference time.



- After the master sent a query, if the transmission waiting time is shorter than the time to switch to the reception status, a response may not be received or the data may be missed.
- When the timeout period is set in the mater, set it to be equal to or longer than the time corresponding to the silent interval (C3.5) plus the value set in the "Transmission waiting time" parameter (P1).
- If frames are received at an interval shorter than the required silent interval, the frames are discarded and a communication error occurs. When a communication error occurs, check the silent interval of the slave and reset the frame transmission interval.
- The silent interval may vary depending on the product series connected. When connecting multiple product series, set parameters as follows.
 - "Silent interval" parameter: "0.0: Set automatically"
 - "Transmission waiting time" parameter: 1.0 ms or more
- If the setting of the "Silent interval" parameter is common to systems in which only products with the "Silent interval" parameter are connected, the communication cycle can be improved. Use in a state of setting to "0.0: Set automatically" normally.

11.2 Message structure

The message format is shown below.

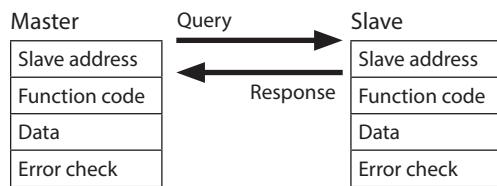

11.2.1 Query

The query message structure is shown below.

Slave address	Function code	Data	Error check
8 bits	8 bits	N x 8 bits	16 bits

■ Slave address

Specify the slave address. (Unicast mode)

If the slave address is set to "0," the master can send a query to all slaves. (Broadcast mode)

■ Function code

The function codes and message lengths supported by the driver are as follows.

Function code	Function	Number of registers	Broadcast
03h	Reading from a holding register(s)	1 to 125	Not possible
06h	Writing to a holding register.	1	Possible
08h	Diagnosis	–	Not possible
10h	Writing to multiple holding registers	1 to 123	Possible
17h	Read/write of multiple holding registers	Read: 1 to 125 Write: 1 to 121	Not possible

■ Data

Set data associated with the function code. The data length varies depending on the function code.

■ Error check

In the Modbus RTU mode, error checks are based on the CRC-16 method. The slave calculates a CRC-16 of each received message and compares the result against the error check value included in the message. If the calculated CRC-16 value matches the error check value, the slave determines that the message is normal.

● CRC-16 calculation method

1. Calculate an exclusive-OR (XOR) value of the default value of FFFFh and slave address (8 bits).
2. Shift the result of step 1 to the right by 1 bit. Repeat this shift until the overflow bit becomes "1."
3. Upon obtaining "1" as the overflow bit, calculate an XOR of the result of step 2 and A001h.
4. Repeat steps 2 and 3 until a shift is performed eight times.
5. Calculate an XOR of the result of step 4 and function code (8 bits).
Repeat steps 2 to 4 for all bytes.
The final result gives the result of CRC-16 calculation.

● Calculation example of CRC-16

The table shows a calculation example when setting the slave address of the first byte to 02h and the function code of the second byte to 07h.

The result of actual CRC-16 calculation is calculated including the data on and after the third byte.

Description	Result	Bit shifted out
CRC register initial value FFFFh	1111 1111 1111 1111	–
Lead byte 02h	0000 0000 0000 0010	–
Initial value FFFFh and XOR	1111 1111 1111 1101	–
First time of right shift	0111 1111 1111 1110	1
A001h and XOR	1010 0000 0000 0001 1101 1111 1111 1111	–
Second time of right shift	0110 1111 1111 1111	1
A001h and XOR	1010 0000 0000 0001 1100 1111 1111 1110	–
Third time of right shift	0110 0111 1111 1111	0
Fourth time of right shift	0011 0011 1111 1111	1
A001h and XOR	1010 0000 0000 0001 1001 0011 1111 1110	–
Fifth time of right shift	0100 1001 1111 1111	0
Sixth time of right shift	0010 0100 1111 1111	1
A001h and XOR	1010 0000 0000 0001 1000 0100 1111 1110	–
Seventh time of right shift	0100 0010 0111 1111	0
Eighth time of right shift	0010 0001 0011 1111	1
A001h and XOR	1010 0000 0000 0001 1000 0001 0011 1110	–
Next byte 07h and XOR	0000 0000 0000 0111 1000 0001 0011 1001	–
First time of right shift	0100 0000 1001 1100	1
A001h and XOR	1010 0000 0000 0001 1110 0000 1001 1101	–
Second time of right shift	0111 0000 0100 1110	1
A001h and XOR	1010 0000 0000 0001 1101 0000 0100 1111	–
Third time of right shift	0110 1000 0010 0111	1
A001h and XOR	1010 0000 0000 0001 1100 1000 0010 0110	–
Fourth time of right shift	0110 0100 0001 0011	0
Fifth time of right shift	0011 0010 0000 1001	1
A001h and XOR	1010 0000 0000 0001 1001 0010 0000 1000	–
Sixth time of right shift	0100 1001 0000 0100	0
Seventh time of right shift	0010 0100 1000 0010	0
Eighth time of right shift	0001 0010 0100 0001	0
Result of CRC-16	0001 0010 0100 0001	–

11.2.2 Response

Slave-returned responses are classified into three types: normal response, no response, and exception response. The response message structure is the same as the query message structure.

Slave address	Function code	Data	Error check
8 bits	8 bits	N x 8 bits	16 bits

■ Normal response

Upon receiving a query from the master, the slave executes the requested process and returns a response corresponding to the function code.

■ No response

The slave may not return a response to a query sent by the master. This condition is referred to as "No response." The causes of no response are explained below.

● Transmission error

The slave discards the query if any of the transmission errors in the table is detected. No response is returned.

Cause of transmission error	Description
Framing error	Stop bit 0 was detected.
Parity error	A mismatch with the specified parity was detected.
Mismatched CRC	The calculated value of CRC-16 was found not matching the error check value.
Invalid message length	The message length exceeded 256 bytes.

● Other than transmission error

A response may not be returned without any transmission error being detected.

Cause	Description
Broadcast	If the query was broadcast, the slave executes the requested process but does not return a response.
Mismatched slave address	When the slave address in the query is not matched the slave address of the driver.

■ Exception response

An exception response is returned if the slave cannot execute the process requested by the query. Appended to this response is an exception code indicating why the process cannot be executed. The message structure of exception response is as follows.

Slave address	Function code	Exception code	Error check
8 bits	8 bits	8 bits	16 bits

● Function code

The function code in the exception response is a sum of the function code in the query and 80h.

Function code of query	Exception response
03h	83h
06h	86h
08h	88h
10h	90h
17h	97h

● Example of exception response

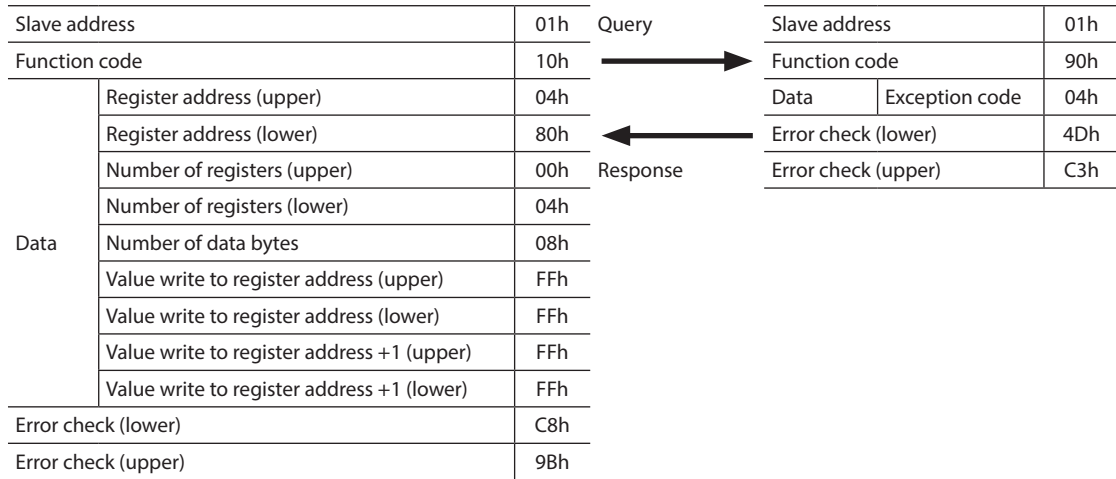

● Exception code

This code indicates why the process cannot be executed.

Exception code	Communication error code	Cause	Description
01h	88h	Invalid function	The process could not be executed because the function code was invalid. ● The function code is not supported. ● The sub-function code for diagnosis (08h) is other than 00h.
02h	88h	Invalid data address	The process could not be executed because the data address was invalid. ● The register address is not supported (other than 0000h to 57FFh). ● The register address and the number of registers are 5800h or more in total.
03h	8Ch	Invalid data	The process could not be executed because the data was invalid. ● The number of registers is 0. ● The number of bytes is other than "the number of register ×2." ● The data length exceeds the maximum value.
04h	89h 8Ah 8Ch 8Dh	Slave error	The process could not be executed because an error occurred at the slave. ● Communication with user I/F is in progress (89h). Execute the following with the MEXE02 - Download (under writing to the driver) - Initialization or Configuration - I/O test or teaching function is being performed ● NV memory processing in progress (8Ah) - Internal processing is in progress (S-BSY is ON). - An alarm of the EEPROM error is present ● Outside the parameter setting range (8Ch) - The value write is outside the setting range. ● Command execute disable (8Dh)

● About slave error

When the "Slave error response mode" parameter is set to "0: Normal response is returned," even if the slave error occurs, a normal response is returned. Set it when no exception response is required, as in the case of a touch screen.

11.3 Function code

This section explains the function codes supported by the **BLH** Series RS-485 communication type driver.
Note that the function code cannot be executed if function codes other than those introduced here are sent.

11.3.1 Reading from a holding register(s) (03h)

This function code is used to read a register (16 bits). Up to 125 successive registers (125×16 bits) can be read.
Read the upper and lower data at the same time. If they are not read at the same time, the value may be invalid.
If multiple holding registers are read, they are read in order of register addresses.

■ Example of read

Read the "Rotation speed" in the operation data Nos. 0 and 1 of the slave address 1.



Using the indirect reference function can set multiple items in consecutive addresses.

Description	Register address	Value read	
		Corresponding hexadecimal	Corresponding decimal
Rotation speed of operation data No.0 (upper)	1152 (0480h)	0000h	500
Rotation speed of operation data No.0 (lower)	1153 (0481h)	01F4h	
Rotation speed of operation data No.1 (upper)	1154 (0482h)	0000h	2500
Rotation speed of operation data No.1 (lower)	1155 (0483h)	09C4h	

● Query

Field name	Data	Description
Slave address	01h	Slave address 1
Function code	03h	Reading from holding registers
Data	Register address (upper)	Register address to start reading from
	Register address (lower)	
	Number of registers (upper)	Number of registers to be read from the starting register address (4 registers=0004h)
	Number of registers (lower)	
Error check (lower)	44h	Calculation result of CRC-16
Error check (upper)	D1h	

● Response

Field name	Data	Description	
Slave address	01h	Same as query	
Function code	03h	Same as query	
Data	Number of data bytes	08h	Value of twice the number of registers in the query
	Value read from register address (upper)	00h	Value read from register address 0480h
	Value read from register address (lower)	00h	
	Value read from register address +1 (upper)	01h	Value read from register address 0481h
	Value read from register address +1 (lower)	F4h	
	Value read from register address +2 (upper)	00h	Value read from register address 0482h
	Value read from register address +2 (lower)	00h	
	Value read from register address +3 (upper)	09h	Value read from register address 0483h
	Value read from register address +3 (lower)	C4h	
Error check (lower)	22h	Calculation result of CRC-16	
Error check (upper)	10h		

11.3.2 Writing to a holding register (06h)

This function code is used to write data to a specified register address. However, since the result combining the upper and lower may be outside the data range, write the upper and lower at the same time using the "Writing to multiple holding registers (10h)."

■ Example of write

Write 1000 (03E8h) to the speed upper limit of the slave address 2.

Description	Register address	Value write	
		Corresponding hexadecimal	Corresponding decimal
Speed upper limit (lower)	4171 (104Bh)	03E8h	1000

● Query

Field name	Data	Description
Slave address	02h	Slave address 2
Function code	06h	Writing to a holding register
Data	Register address (upper)	10h
	Register address (lower)	4Bh
	Value write (upper)	03h
	Value write (lower)	E8h
Error check (lower)	FDh	Calculation result of CRC-16
Error check (upper)	91h	

● Response

Field name	Data	Description
Slave address	02h	Same as query
Function code	06h	Same as query
Data	Register address (upper)	10h
	Register address (lower)	4Bh
	Value write (upper)	03h
	Value write (lower)	E8h
Error check (lower)	FDh	Calculation result of CRC-16
Error check (upper)	91h	

11.3.3 Diagnosis (08h)

This function code is used to diagnose the communication between the master and slave. Arbitrary data is sent and the result of returned data is used to determine whether the communication is normal. 00h (reply to query) is the only sub-function.

■ Example of diagnosis

Send arbitrary data (1234h) to the slave for diagnosis.

● Query

Field name		Data	Description
Slave address		03h	Slave address 3
Function code		08h	Diagnosis
Data	Sub-function code (upper)	00h	Return the query data
	Sub-function code (lower)	00h	
	Data value (upper)	12h	Arbitrary data (1234h)
	Data value (lower)	34h	
Error check (lower)		ECh	Calculation result of CRC-16
Error check (upper)		9Eh	

● Response

Field name		Data	Description
Slave address		03h	Same as query
Function code		08h	Same as query
Data	Register address (upper)	00h	Same as query
	Register address (lower)	00h	
	Data value (upper)	12h	Same as query
	Data value (lower)	34h	
Error check (lower)		ECh	Calculation result of CRC-16
Error check (upper)		9Eh	

11.3.4 Writing to multiple holding registers (10h)

This function code is used to write data to multiple successive registers. Up to 123 registers can be written. Make sure the register value is a multiple of 2.

Write the data to the upper and lower at the same time. If not, an invalid value may be written.

Registers are written in order of register addresses. Note that even when an exception response is returned because some data is invalid as being outside the specified range, etc., other data may have been written properly.

■ Example of write

Set the following data to the "Torque limiting value" in the operation data Nos. 0 to 3 of the slave address 4.



Using the indirect reference function can set multiple items in consecutive addresses.

Description	Register address	Value write	
		Corresponding hexadecimal	Corresponding decimal
Torque limiting value of operation data No.0 (upper)	1792 (0700h)	0000h	200
Torque limiting value of operation data No.0 (lower)	1793 (0701h)	00C8h	
Torque limiting value of operation data No.1 (upper)	1794 (0702h)	0000h	100
Torque limiting value of operation data No.1 (lower)	1795 (0703h)	0064h	
Torque limiting value of operation data No.2 (upper)	1796 (0704h)	0000h	20
Torque limiting value of operation data No.2 (lower)	1797 (0705h)	0014h	
Torque limiting value of operation data No.3 (upper)	1798 (0706h)	0000h	50
Torque limiting value of operation data No.3 (lower)	1799 (0707h)	0032h	

● Query

Field name		Data	Description
Slave address		04h	Slave address 4
Function code		10h	Writing to multiple holding registers
Data	Register address value (upper)	07h	Register address to start writing from
	Register address value (lower)	00h	
	Number of registers (upper)	00h	Number of registers to be written from the starting register address (8 registers=0008h)
	Number of registers (lower)	08h	
	Number of data bytes	10h	Value of twice the number of registers in the query (8 registers × 2 = 16 registers: 10h)
	Value write to register address (upper)	00h	Value written to register address 0700h
	Value write to register address (lower)	00h	
	Value write to register address +1 (upper)	00h	Value written to register address 0701h
	Value write to register address +1 (lower)	C8h	
	Value write to register address +2 (upper)	00h	Value written to register address 0702h
	Value write to register address +2 (lower)	00h	
	Value write to register address +3 (upper)	00h	Value written to register address 0703h
	Value write to register address +3 (lower)	64h	
	Value write to register address +4 (upper)	00h	Value written to register address 0704h
	Value write to register address +4 (lower)	00h	
	Value write to register address +5 (upper)	00h	Value written to register address 0705h
	Value write to register address +5 (lower)	14h	
	Value write to register address +6 (upper)	00h	Value written to register address 0706h
	Value write to register address +6 (lower)	00h	
	Value write to register address +7 (upper)	00h	Value written to register address 0707h
Value write to register address +7 (lower)	32h		
Error check (lower)		A5h	Calculation result of CRC-16
Error check (upper)		48h	

● Response

Field name		Data	Description
Slave address		04h	Same as query
Function code		10h	Same as query
Data	Register address value (upper)	07h	Same as query
	Register address value (lower)	00h	
	Number of registers (upper)	00h	Same as query
	Number of registers (lower)	08h	
Error check (lower)		C0h	Calculation result of CRC-16
Error check (upper)		EEh	

11.3.5 Read/write of multiple holding registers (17h)

With a single function code, reading data and writing data for multiple successive registers can be performed. Data is written first, and then data is read from the specified registers.

- **Read**

Data can be read from successive registers of up to 125.

Read the upper and lower data at the same time. If they are not read at the same time, the value may be invalid.

If multiple registers are read, they are read in order of register addresses.

- **Write**

Data can be written to successive registers of up to 121.

Write the data to the upper and lower at the same time. If not, an invalid value may be written.

Registers are written in order of register addresses. Note that even when an exception response is returned because some data is invalid as being outside the specified range, etc., other data may have been written properly.

- **Example of read/write**

Prepare the read address and write address in a single query.

In this example, after writing the data to "Rotation speed" in the operation data No. 1, read the "Feedback speed" and "Load factor:"

This is an example when the feedback speed is assigned to the indirect reference 6 and the load factor is assigned to the indirect reference 7. (Factory setting)

Description	Register address	Value write	
		Corresponding hexadecimal	Corresponding decimal
Indirect reference 6 (upper)	4876 (130Ch)	0000h	500
Indirect reference 6 (lower)	4877 (130Dh)	01F4h	
Indirect reference 7 (upper)	4878 (130Eh)	0000h	50
Indirect reference 7 (lower)	4879 (130Fh)	0032h	

Description	Register address	Value write	
		Corresponding hexadecimal	Corresponding decimal
Rotation speed of operation data No.0 (upper)	1152 (0480h)	0000h	500
Rotation speed of operation data No.0 (lower)	1153 (0481h)	01F4h	
Rotation speed of operation data No.1 (upper)	1154 (0482h)	0000h	2500
Rotation speed of operation data No.1 (lower)	1155 (0483h)	09C4h	

● Query

Field name	Data	Description
Slave address	01h	Slave address 1
Function code	17h	Read/write of multiple holding registers
Data	(Read) Register address value (upper)	13h
	(Read) Register address value (lower)	0Ch
	(Read) Number of registers (upper)	00h
	(Read) Number of registers (lower)	04h
	(Write) Register address value (upper)	04h
	(Write) Register address value (lower)	80h
	(Write) Number of registers (upper)	00h
	(Write) Number of registers (lower)	04h
	(Write) Number of data bytes	08h
	Value write to register address (upper)	00h
	Value write to register address (lower)	00h
	Value write to register address +1 (upper)	01h
	Value write to register address +1 (lower)	F4h
	Value write to register address +2 (upper)	00h
	Value write to register address +2 (lower)	00h
	Value write to register address +3 (upper)	09h
	Value write to register address +3 (lower)	C4h
Error check (lower)	CCh	
Error check (upper)	B4h	

● Response

Field name	Data	Description
Slave address	01h	Same as query
Function code	17h	Same as query
Data	(Read) Number of data bytes	08h
	(Read) Value read from register address (upper)	00h
	(Read) Value read from register address (lower)	00h
	(Read) Value read from register address +1 (upper)	01h
	(Read) Value read from register address +1 (lower)	F4h
	(Read) Value read from register address +2 (upper)	00h
	(Read) Value read from register address +2 (lower)	00h
	(Read) Value read from register address +3 (upper)	00h
(Read) Value read from register address +3 (lower)	32h	
Error check (lower)	E4h	
Error check (upper)	46h	

11.4 Flow of setting required for Modbus communication

If you are new to this product, read this section to understand the operating methods along with the operation flow. This is an example how to set operation data and parameters to the driver and operate the motor using a host controller.

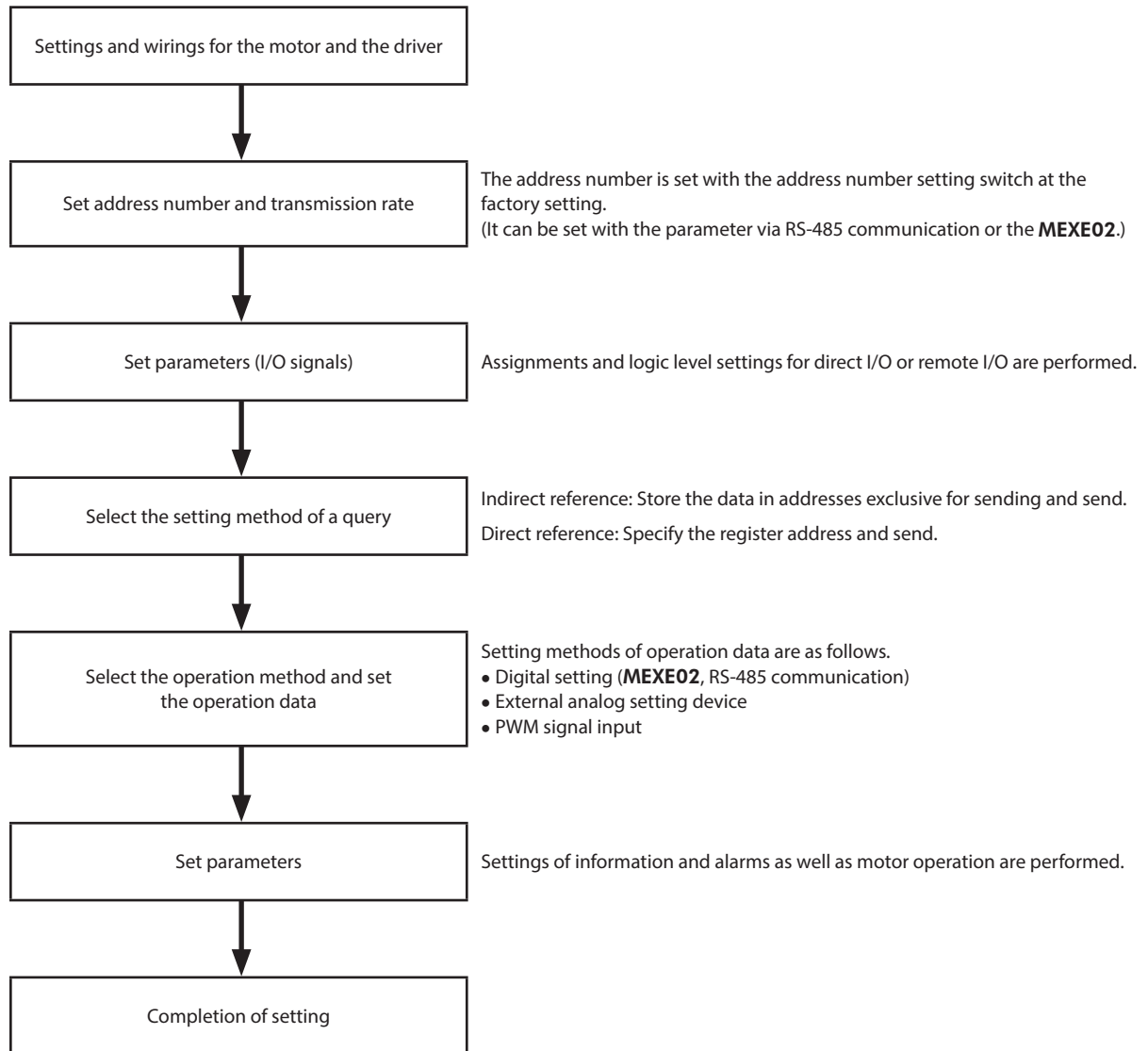

Refer to p.29 for the guidance to operate the motor by setting the operation data and parameters using a host controller.

11.5 Setting of RS-485 communication

Set parameters required for RS-485 communication before performing communication. Use the **MEXE02** to set parameters.

11.5.1 Parameters updated when turning on the power

These are parameters related to sending and receiving via RS-485 communication.

- They are out of the range of Configuration.
- They are not initialized even if "Batch data initialization" of the maintenance command is executed.
- They are initialized if "All data batch initialization" of the maintenance command is executed.
Turning on the power again after "All data batch initialization" was executed may change the communication setting, thereby causing communication to disable.
- They are initialized if "Restored to the factory setting" of the **MEXE02** is executed.

Parameter name	Description	Initial value
Communication ID	Sets the address number (slave address).	-1: The switch setting is of the driver followed
Baudrate	Sets the transmission rate.	4: 115,200 bps
Communication order	Sets the byte order of 32-bit data.	0: Even Address-High Word & Big-Endian
Communication parity	Sets the communication parity for RS-485 communication.	1: Even parity
Communication stop bit	Sets the communication stop bit for RS-485 communication.	0: 1 bit
Transmission waiting time	Sets the transmission waiting time for RS-485 communication.	3.0 ms
Silent interval	This is a parameter to set the silent interval.	0.0: Set automatically

11.5.2 Parameters updated immediately after rewriting

These are parameters related to communication alarms, information, and error detection. They are updated immediately after the parameter is rewritten.

Parameter name	Description	Initial value
RS-485 communication timeout alarm	Sets the condition in which the RS-485 communication timeout alarm is generated.	0: Not monitored
RS-485 communication error alarm	Sets the condition in which the RS-485 communication error alarm is generated.	3
RS-485 communication error information	Sets the condition in which the RS-485 communication error information is generated.	3
Slave error response mode	Sets the response when the slave error occurred.	1: Exception response is returned

11.6 Data setting method

11.6.1 Overview of setting method

There are two methods to set data via Modbus communication.

The communication specifications of Modbus allows reading/writing from/to successive addresses when multiple data pieces are handled.

Input method	Description
Direct reference	<ul style="list-style-type: none"> Data is set by specifying the address. If the data consists of successive addresses, multiple data pieces can be handled with one query.
Indirect reference	<ul style="list-style-type: none"> Indirect reference is a method in which data is stored in addresses exclusive for sending (indirect reference addresses) and set. Even if addresses of the data to be set are not successive, multiple data can be handled with one query because the indirect reference addresses are successive. (It is required to set an item to be set in the indirect reference address parameter.)

11.6.2 Direct reference

Direct reference is a method in which data is set by specifying addresses. Multiple successive addresses can be sent with one query. However, if addresses to be set are not successive, queries as many as the number of addresses should be sent.

11.6.3 Indirect reference

Indirect reference is a function in which an arbitrary command can be assigned to the indirect reference address.

(The number of commands that can be set is 32 pieces (0 to 31).)

If addresses to be set are not successive, the number of queries to be sent can be decreased by using indirect reference.

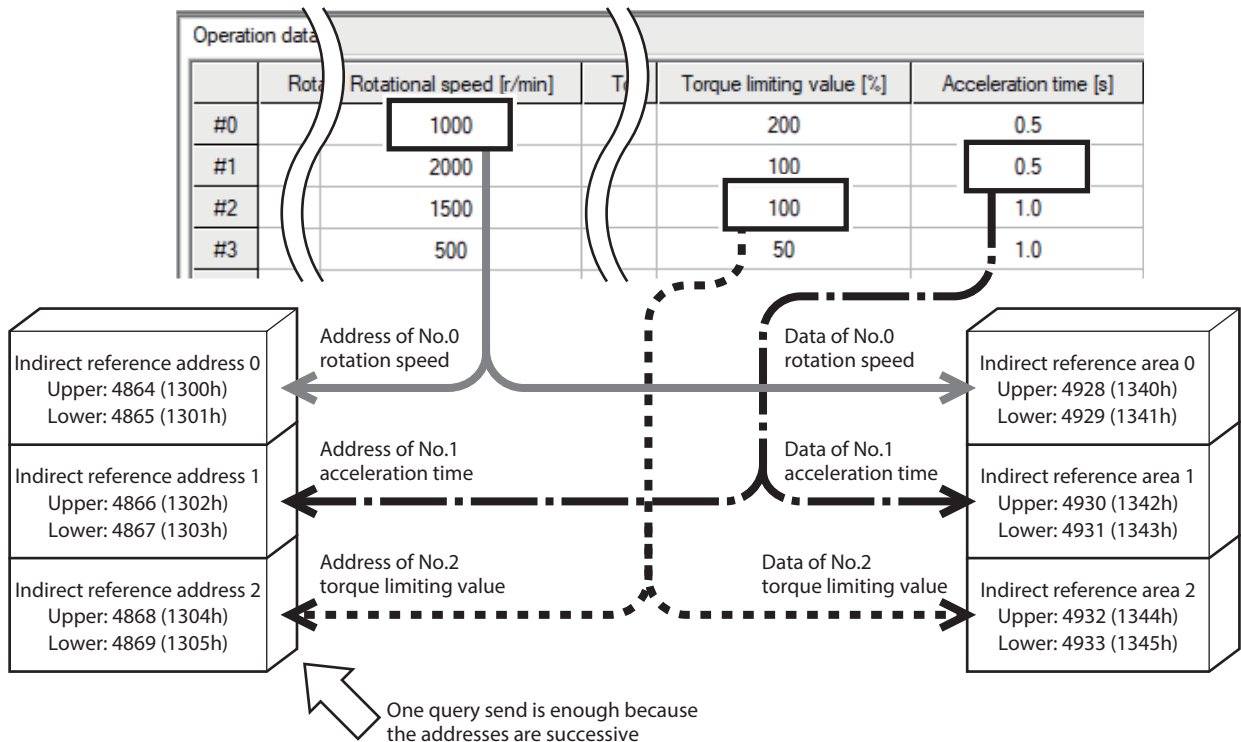

■ Addresses and areas of indirect reference

Indirect reference has 32 addresses and 32 areas (0 to 31).

The indirect reference addresses are used only to assign the commands.

The address used to read (03h), write (10h), or read/write (17h) the assigned command is that of the corresponding indirect reference area.

Name	Description
Indirect reference address (0)	Sets the command to be used in indirect reference. Input a half value of the register address (upper) to be set. When setting via RS-485 communication, input the value in the lower of the indirect reference address and "0" in the upper side.
Indirect reference address (1)	
•	
•	
Indirect reference address (30)	
Indirect reference address (31)	
Indirect reference area 0	The read result of the command assigned by the indirect reference address or the data to be written is stored.
Indirect reference area 1	
•	
•	
Indirect reference area 30	
Indirect reference area 31	

Related parameters

Parameter name	Description	Setting range	Factory setting	Update
Indirect reference address setting (0)	Sets a half value of the register address (upper) to be stored in the indirect reference addresses (0) to (31).	0 to 65,535 (0 to FFFFh)	576: Operation data No.0 rotation speed	A
Indirect reference address setting (1)			896: Operation data No.0 torque limiting value	
Indirect reference address setting (2)			768: Operation data No.0 acceleration time	
Indirect reference address setting (3)			832: Operation data No.0 deceleration time	
Indirect reference address setting (4)			62: Driver input command	
Indirect reference address setting (5)			98: Selection number	
Indirect reference address setting (6)			103: Feedback speed	
Indirect reference address setting (7)			108: Load factor	
Indirect reference address setting (8)			63: Remote output	
Indirect reference address setting (9)			64: Present alarm	
Indirect reference address setting (10)			123: Information	
Indirect reference address setting (11)			124: Driver temperature	
Indirect reference address setting (12)			163: Inverter voltage	
Indirect reference address setting (13)			157: Rotation amount meter	
Indirect reference address setting (14)			127: Tripmeter	
Indirect reference address setting (15)			126: Odometer	
Indirect reference address setting (16)			160: Main power supply count	
Indirect reference address setting (17)			161: Main power supply time	
Indirect reference address setting (18)			184: I/O status 1	
Indirect reference address setting (19)			185: I/O status 2	
Indirect reference address setting (20)			186: I/O status 3	
Indirect reference address setting (21)			187: I/O status 4	
Indirect reference address setting (22)			188: I/O status 5	
Indirect reference address setting (23)			189: I/O status 6	
Indirect reference address setting (24)			190: I/O status 7	
Indirect reference address setting (25)			191: I/O status 8	
Indirect reference address setting (26)			0: Not used	
Indirect reference address setting (27)			0: Not used	
Indirect reference address setting (28)			0: Not used	
Indirect reference address setting (29)			0: Not used	
Indirect reference address setting (30)			0: Not used	
Indirect reference address setting (31)			0: Not used	

■ Setting example

The following is an example of sending data to and receiving data from the address number 1 using indirect reference.

● STEP 1: Registration in indirect reference addresses

Set data

These are values to set in indirect reference. Set a half value of the register address (upper).

Indirect reference address	Register address		←	Data to be sent	Register address		Setting value
	Upper	Lower			Upper	Lower	
Indirect reference address setting (0)	1300h	1301h	←	Rotation speed of operation data No.1	0482h	0483h	0241h
Indirect reference address setting (1)	1302h	1303h	←	Torque limiting value of operation data No.1	0702h	0703h	0381h
Indirect reference address setting (2)	1304h	1305h	←	Acceleration time of operation data No.1	0602h	0603h	0301h

Send the following query and register the setting value of the data to be sent in the indirect reference addresses.

Query

Field name		Data	Description
Slave address		01h	Slave address 1
Function code		10h	Writing to multiple holding registers
Data	Register address (upper)	13h	Register address to start writing from
	Register address (lower)	00h	
	Number of registers (upper)	00h	Number of registers to be written from the starting register address (6 registers=0006h)
	Number of registers (lower)	06h	
	Number of data bytes	0Ch	Value of twice the number of registers in the query (6 registers×2=12 registers: 0Ch)
	Value write to register address (upper)	00h	Value written to register address 1300h =Rotation speed of operation data No.1
	Value write to register address (lower)	00h	
	Value write to register address +1 (upper)	02h	
	Value write to register address +1 (lower)	41h	
	Value write to register address +2 (upper)	00h	Value written to register address 1302h =Torque limiting value of operation data No.1
	Value write to register address +2 (lower)	00h	
	Value write to register address +3 (upper)	03h	
	Value write to register address +3 (lower)	81h	
	Value write to register address +4 (upper)	00h	Value written to register address 1304h =Acceleration time of operation data No.1
	Value write to register address +4 (lower)	00h	
	Value write to register address +5 (upper)	03h	
Value write to register address +5 (lower)	01h		
Error check (lower)	97h	Calculation result of CRC-16	
Error check (upper)	66h		

Refer to p.114 for the operation data command.

● **STEP 2: Writing to indirect reference areas**

Set data

Indirect reference address	Register address			Data to be sent	Setting value
	Upper	Lower			
Indirect reference area 0	1340h	1341h	←	Rotation speed of operation data No.1 (r/min)	2000 (07D0h)
Indirect reference area 1	1342h	1343h	←	Torque limiting value of operation data No.1 (%)	100 (0064h)
Indirect reference area 2	1344h	1345h	←	Acceleration time of operation data No.1 (× 0.1 s)	30 (001Eh)

Send the following query and write the setting value of the data to be sent in the indirect reference areas.

Query

Field name		Data	Description
Slave address		01h	Slave address 1
Function code		10h	Writing to multiple holding registers
Data	Register address (upper)	13h	Register address to start writing from
	Register address (lower)	40h	
	Number of registers (upper)	00h	Number of registers to be written from the starting register address (6 registers=0006h)
	Number of registers (lower)	06h	
	Number of data bytes	0Ch	Value of twice the number of registers in the query (6 registers×2=12 registers: 0Ch)
	Value write to register address (upper)	00h	Value written to register address 1340h =Rotation speed of operation data No.1 2000 r/min (07D0h)
	Value write to register address (lower)	00h	
	Value write to register address +1 (upper)	07h	
	Value write to register address +1 (lower)	D0h	
	Value write to register address +2 (upper)	00h	Value written to register address 1342h =Torque limiting value of operation data No.1 100% (0064h)
	Value write to register address +2 (lower)	00h	
	Value write to register address +3 (upper)	00h	
	Value write to register address +3 (lower)	64h	
	Value write to register address +4 (upper)	00h	Value written to register address 1344h =Acceleration time of operation data No.1 3.0 s (001Eh)
	Value write to register address +4 (lower)	00h	
	Value write to register address +5 (upper)	00h	
Value write to register address +5 (lower)	1Eh		
Error check (lower)	1Bh	Calculation result of CRC-16	
Error check (upper)	CDh		

Refer to p.114 for the operation data command.

● **STEP 3: Reading from indirect reference areas**

Send the following query and read the setting value or monitor set in the indirect reference areas.

Query

Field name		Data	Description
Slave address		01h	Slave address 1
Function code		03h	Reading from holding registers
Data	Register address (upper)	13h	Register address to start reading from =Indirect reference area 0 (1340h)
	Register address (lower)	40h	
	Number of registers (upper)	00h	Number of registers to be read from the starting register address (6 registers=0006h)
	Number of registers (lower)	06h	
Error check (lower)		C0h	Calculation result of CRC-16
Error check (upper)		98h	

Response

Field name		Data	Description
Slave address		01h	Same as query
Function code		03h	Same as query
Data	Number of data bytes	0Ch	Value of the twice the number of registers in the query=12
	Value read from register address (upper)	00h	Value read from register address 1340h =2000 (07D0h)
	Value read from register address (lower)	00h	
	Value read from register address +1 (upper)	07h	
	Value read from register address +1 (lower)	D0h	
	Value read from register address +2 (upper)	00h	Value read from register address 1342h =100 (0064h)
	Value read from register address +2 (lower)	00h	
	Value read from register address +3 (upper)	00h	
	Value read from register address +3 (lower)	64h	Value read from register address 1344h =30 (001Eh)
	Value read from register address +4 (upper)	00h	
	Value read from register address +4 (lower)	00h	
	Value read from register address +5 (upper)	00h	
	Value read from register address +5 (lower)	1Eh	
	Error check (lower)		AFh
Error check (upper)		4Eh	

Refer to p.114 for the operation data command.

11.7 Group send

With the group send, multiple slaves are made into a group and a query is sent to all slaves in the group at once. The function code that can be executed in the group send is "Writing to multiple holding registers (10h)" only.

■ Group composition

A group consists of one parent slave and child slaves and only the parent slave returns a response.

■ Group address

To perform the group send, set a group address to the child slaves to be included in the group. The child slaves to which the group address has been set can receive a query sent to the parent slave.

The parent slave is not always required. A group can be composed by only child slaves. In this case, set an unused address as an address of the group.

When a query is sent from the master to the address of the group, the child slaves execute the process.

However, no response is returned. In broadcasting, all the slaves execute the process, however, the slaves that execute the process can be limited in this method.

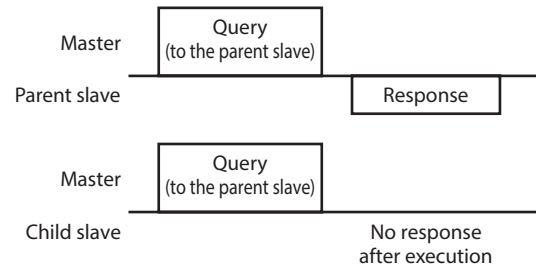

■ Parent slave

No special setting is required on the parent slave to perform the group send. The address of the parent slave becomes the group address. When a query is sent from the master to the parent slave, the parent slave executes the requested process and returns a response. (Same as the unicast mode)

■ Child slave

Slaves to which the address of the parent slave is set become the child slaves.

When a query sent to the address of the group is received, the child slaves execute the process. However, no response is returned.

■ Setting of Group

The methods to set a group are one of the following.

- Set by the command
- Set by the parameter

● Set by the command

To set a group, set the address of the parent slave to the "Group ID" of the child slaves.

Change the group in the unicast mode. For reading and writing when setting the "Group ID," execute the upper and lower parameters at the same time.

Related commands

Register address		Name	Description	Factory setting	R/W
Dec	Hex				
48	0030h	Group ID (upper)	Set a group address to the child slaves to be included in the group. [Setting range]	-1	R/W
49	0031h	Group ID (lower)	-1: No group specification (group send is not performed) 1 to 15: The address (address of the parent slave) of the group		



- Do not set "0" to the group ID.
- Change the group address in the unicast mode.
- The group setting is not saved in the non-volatile memory even when the "Write batch NV memory" of the maintenance command is executed (it is saved in the RAM). The group setting (Group ID) is returned to the initial value when the power supply of the driver is turned off. Every time the power supply is turned on, reset the group setting or set with the parameter.

● **Set by the parameter**

The setting value of the "Group ID" command is saved in the RAM. In this case, if the power supply is turned off, the setting will be returned to the initial value and the group will be released. Therefore, the group is needed to set again every time after the power supply is turned on. On the other hand, the "Initial group ID" parameter is stored in the non-volatile memory. If a group is set in this parameter, the group will not be released even when the power supply is turned off. The group function can be used immediately when the power supply is turned on.

Related parameter

Parameter name	Description	Setting range	Factory setting
Initial group ID	Sets the address of a group (address number of parent slave). It is stored even if the power is turned off.	-1: Disable (no group transmission) 1 to 15: Group ID ※ Do not use 0.	-1

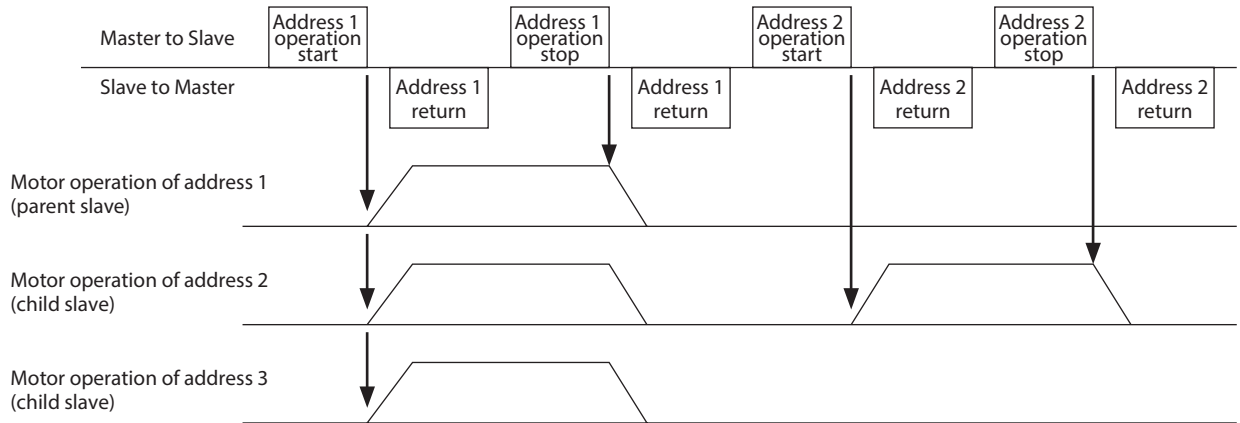
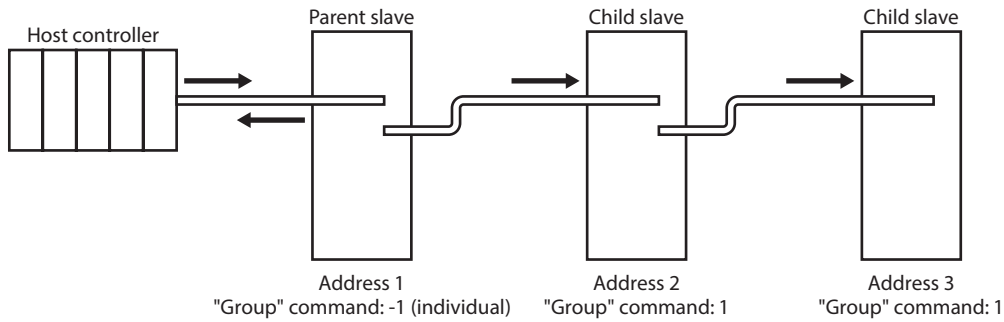

11.8 Setting example

As an example, this section explains how to perform the following operation.

● Setting example

- Address number (slave address): 1
- Operation data number: 0
- Rotation speed setting value: 2000 r/min
- Torque limiting setting value: 100
- Acceleration time setting value: 10 (=1.0 s)
- Deceleration time setting value: 5 (=0.5 s) (initial value)

● Operation input

Remote input, 3-Wire mode (initial value)

11.8.1 Setting with direct reference

1. Send the following query to set each operation data of the operation data No.1.

● Query (setting of rotation speed)

Field name		Data	Description
Slave address		01h	Slave address 1
Function code		06h	Writing to a holding register
Data	Register address (upper)	04h	Register address to be written
	Register address (lower)	81h	
	Value write (upper)	07h	Value written to register address =2000
	Value write (lower)	D0h	
Error check (lower)		DBh	Calculation result of CRC-16
Error check (upper)		7Eh	

* The response is the same as the query.

● Query (setting of torque limiting value)

Field name		Data	Description
Slave address		01h	Slave address 1
Function code		06h	Writing to a holding register
Data	Register address (upper)	07h	Register address to be written
	Register address (lower)	01h	
	Value write (upper)	00h	Value written to register address =100
	Value write (lower)	64h	
Error check (lower)		D8h	Calculation result of CRC-16
Error check (upper)		95h	

* The response is the same as the query.

● Query (setting of acceleration time)

Field name		Data	Description
Slave address		01h	Slave address 1
Function code		06h	Writing to a holding register
Data	Register address (upper)	06h	Register address to be written
	Register address (lower)	01h	
	Value write (upper)	00h	Value written to register address =10
	Value write (lower)	0Ah	
Error check (lower)		58h	Calculation result of CRC-16
Error check (upper)		85h	

* The response is the same as the query.

2. Send the following query to operate I/O and start an operation in the forward direction. The initial values of remote input are as follows.

- Remote input (lower): 125 (007Dh)

bit15	bit14	bit13	bit12	bit11	bit10	bit9	bit8
R-IN15 [Not used]	R-IN14 [Not used]	R-IN13 [Not used]	R-IN12 [Not used]	R-IN11 [Not used]	R-IN10 [Not used]	R-IN9 [Not used]	R-IN8 [Not used]
bit7	bit6	bit5	bit4	bit3	bit2	bit1	bit0
R-IN7 [ALM-RST]	R-IN6 [Not used]	R-IN5 [FWD/REV]	R-IN4 [RUN/BRAKE]	R-IN3 [START/STOP]	R-IN2 [M2]	R-IN1 [M1]	R-IN0 [M0]

Values in brackets [] are initial values. The function to be assigned can be changed with the parameter setting.

- Query (ON-OFF of input signal)

Field name		Data	Description
Slave address		01h	Slave address 1
Function code		06h	Writing to a holding register
Data	Register address (upper)	00h	Register address to be written
	Register address (lower)	7Dh	
	Value write (upper)	00h	Value written to register address =Turn bit3 to bit5 ON
	Value write (lower)	38h	
Error check (lower)		18h	Calculation result of CRC-16
Error check (upper)		00h	

* The response is the same as the query.

3. To stop the operation, if the following query is sent to turn the START/STOP input OFF, the motor decelerates to a stop. (If the RUN/BRAKE input is turned OFF, the motor stops instantaneously).

- Query (ON-OFF of input signal)

Field name		Data	Description
Slave address		01h	Slave address 1
Function code		06h	Writing to a holding register
Data	Register address (upper)	00h	Register address to be written
	Register address (lower)	7Dh	
	Value write (upper)	00h	Value written to register address =Turn bit4 to bit5 ON (turn bit3 OFF)
	Value write (lower)	30h	
Error check (lower)		19h	Calculation result of CRC-16
Error check (upper)		C6h	

* The response is the same as the query.

* Setting the value of the rotation speed to 0 r/min can make the motor decelerate to a stop even if the operation input signal is in an ON state.

11.8.2 Setting with indirect reference

- Send the following query to set each operation data of the operation data No.0 and start an operation in the forward direction.

- Query

Field name		Data	Description	
Slave address		01h	Slave address 1	
Function code		10h	Writing to multiple holding registers	
Data	Register address (upper)	13h	Register address to start writing from	
	Register address (lower)	40h		
	Number of registers (upper)	00h	Number of registers to be written from the starting register address (10 registers=000Ah)	
	Number of registers (lower)	0Ah		
	Number of data bytes		14h	Value of twice the number of registers in the query (10 registers×2=20 registers: 14h)
	Value write to register address (upper)		00h	Value written to register address 1340h =Rotation speed of operation data No.0 (2000)
	Value write to register address (lower)		00h	
	Value write to register address + 1 (upper)		07h	
	Value write to register address + 1 (lower)		D0h	
	Value write to register address + 2 (upper)		00h	Value written to register address 1342h =Torque limiting value of operation data No.0 (100)
	Value write to register address + 2 (lower)		00h	
	Value write to register address + 3 (upper)		00h	
	Value write to register address + 3 (lower)		64h	
	Value write to register address + 4 (upper)		00h	Value written to register address 1344h =Acceleration time of operation data No.0 (10)
	Value write to register address + 4 (lower)		00h	
	Value write to register address + 5 (upper)		00h	
	Value write to register address + 5 (lower)		0Ah	
	Value write to register address + 6 (upper)		00h	Value written to register address 1346h =Deceleration time of operation data No.0 (5) (initial value)
	Value write to register address + 6 (lower)		00h	
	Value write to register address + 7 (upper)		00h	
Value write to register address + 7 (lower)		05h		
Value write to register address + 8 (upper)		00h	Value written to register address 1348h =Remote input upper (0) (0000 0000 0000 0000) =Remote input lower (38) (0000 0000 0011 1000)	
Value write to register address + 8 (lower)		00h		
Value write to register address + 9 (upper)		00h		
Value write to register address + 9 (lower)		38h		
Error check (lower)		39h	Calculation result of CRC-16	
Error check (upper)		2Dh		

* The timing to update the new setting of operation data is "A: Update immediately." Therefore, only changing the value in the rotation speed can change the motor speed.

- Response

Field name		Data	Description
Slave address		01h	Same as query
Function code		10h	Same as query
Data	Register address (upper)	13h	Same as query
	Register address (lower)	40h	
	Number of registers (upper)	00h	Same as query
	Number of registers (lower)	0Ah	
Error check (lower)		45h	Calculation result of CRC-16
Error check (upper)		5Eh	

2. To stop the operation, if the following query is sent to turn the START/STOP input OFF, the motor decelerates to a stop. (If the RUN/BRAKE input is turned OFF, the motor stops instantaneously.)

- Query (ON-OFF of input signal)

Field name		Data	Description
Slave address		01h	Slave address 1
Function code		06h	Writing to a holding register
Data	Register address (upper)	13h	Register address to be written
	Register address (lower)	49h	
	Value write (upper)	00h	Value written to register address =Turn bit4 to bit5 ON (turn bit3 OFF)
	Value write (lower)	30h	
Error check (lower)		5Ch	Calculation result of CRC-16
Error check (upper)		8Ch	

- * The response is the same as the query.
- * Setting the value of the rotation speed to 0 r/min can make the motor decelerate to a stop even if the operation input signal is in an ON state.
- * Specifying the register address of the remote input directly can also stop the motor.

11.9 Timing charts

11.9.1 Communication start

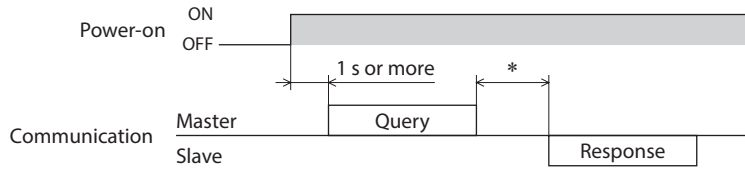

* P1 "transmission waiting time" parameter + C3.5 (silent interval)

11.9.2 Operation start

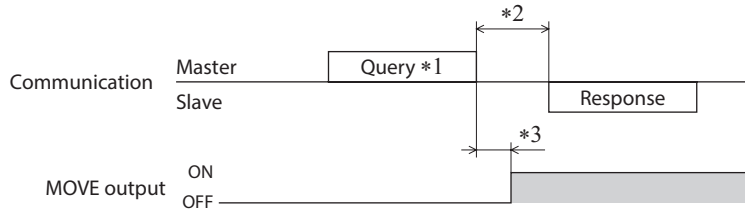

*1 A message including a query to start operation via RS-485 communication

*2 P1 "transmission waiting time" parameter + C3.5 (silent interval)

*3 C3.5 (silent interval) + 2 ms or less

11.9.3 Operation stop, speed change

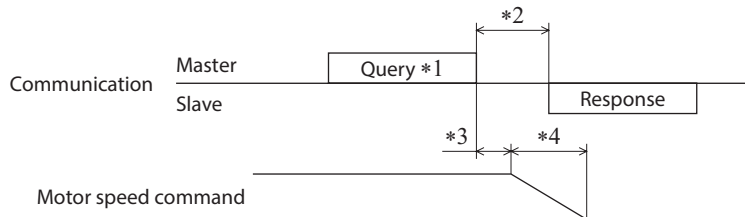

*1 A message including a query to stop operation and another to change the speed via RS-485 communication

*2 Command processing time + C3.5 (silent interval) + P1 "transmission waiting time" parameter

*3 Command processing time + C3.5 (silent interval) + 2 ms or less

*4 It varies depending on the setting value of the acceleration time and deceleration time or a load condition.

11.9.4 Input signals

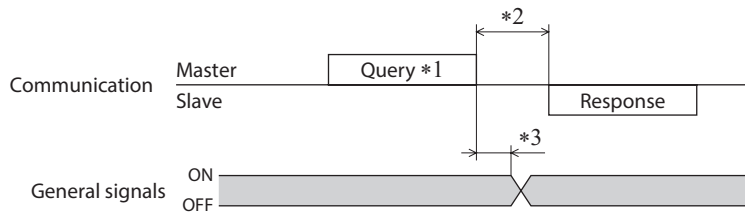

*1 A message including remote output via RS-485 communication

*2 P1 "transmission waiting time" parameter + C3.5 (silent interval)

*3 C3.5 (silent interval) + 2 ms or less

11.9.5 Configuration

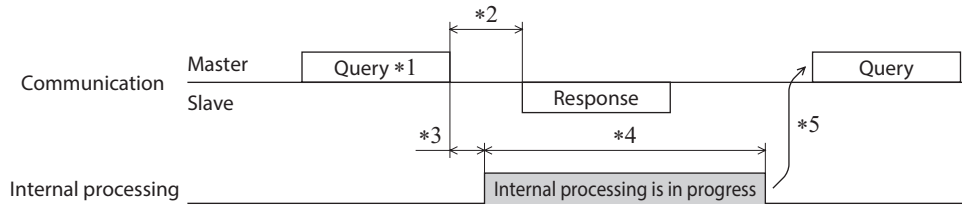

- *1 A message including a query for configuration via RS-485 communication
- *2 P1 "transmission waiting time" parameter + C3.5 (silent interval) + command processing time
- *3 C3.5 (silent interval) + 2 ms or less
- *4 1 s or less
- *5 Execute a query after the driver internal processing is completed.
(Avoid an ON state of SYS-BSY such as a state where Configuration is being executed.)



- If writing is executed in an internal processing state, an communication error occurs.
- The same state will occur if the maintenance command which processing time is long such as "Write batch NV memory." Refer to "12.5 Maintenance commands" on p.104 for corresponding commands.

11.10 Communication monitor

Out of monitor items related to RS-485 communication, items that can be monitored are shown below. Each item can be checked on the RS-485 communication monitor of the **MEXE02** or via RS-485 communication. Refer to p.113 for the address of each monitored items.

Monitored items	Description
Communication error	Monitors the communication error code received last time.
RS-485 communication Reception frame counter	Monitors the number of frames received. The target to count the number of frames received can be selected using the "RS-485 Receive packet monitor" parameter.
RS-485 communication Normal reception frame counter (All)	Monitors the number of normal frames received. *
RS-485 communication Normal reception frame counter (Only own address)	Monitors the number of normal frames received to own address. *
RS-485 communication Abnormal reception frame counter (All)	Monitors the number of abnormal frames received. *
RS-485 communication Transmission frame counter	Monitors the number of frames transmitted.
RS-485 communication Reception byte counter	Monitors the number of bytes received.
RS-485 communication Transmission byte counter	Monitors the number of bytes transmitted.
RS-485 communication Register write abnormal counter	Monitors the number of times that the received data is abnormal (outside setting range, command execute disable, etc.).

- * The judgment of whether it is normal or abnormal is performed based on the mismatched CRC and no missed received data (C1.5).

11.11 Detection of communication errors

The functions to detect that an error occurs in RS-485 communication are three types including communication errors, alarms, and information.

11.11.1 Communication errors

The communication error can be checked using the "Communication error history" command via RS-485 communication or the **MEXE02**. (Ten data in order of the latest)

If the error code 84h of the communication error is generated, the C-DAT/C-ERR LED will be lit in red.

When communication errors other than 84h is generated, the LED will not be lit or blink.



The communication error history is saved in the RAM. It is cleared when the power supply of the driver is turned OFF.

■ Communication errors

Communication errors	Error code	Cause
RS-485 communication error	84h	A transmission error was detected. Refer to "Causes and descriptions of transmission errors" for details.
Command not yet defined	88h	The function code was invalid (exception code 01h) · The function code is not supported. · The sub-function code for diagnosis (08h) is other than 00h.
		The data address was invalid (exception code 02h) · The register address is not supported (other than 0000h to 57FFh). · The register address and the number of registers are 5800h or more in total.
User I/F communication in progress	89h	Download or initialization is being executed with the MEXE02 (exception code 04h)*
Non-volatile memory processing in progress	8Ah	Non-volatile memory processing is in progress (exception code 04h)* · Internal processing is in progress. (SYS-BSY is ON.) · An EEPROM error alarm is present.
Outside setting range	8Ch	The data was invalid (exception code 03h) · The number of registers is 0. · The number of bytes is other than twice the number of registers. · The data length is outside the specified range.
		The value write was out of the setting range (exception code 04h)*
Command execute disable	8Dh	The command could not be executed (exception code 04h)*

* It is the slave error. When the "Slave error response mode" parameter is set to "0: Normal response is returned," even if the slave error occurs, a normal response is returned. Set it when no exception response is required, as in the case of a touch screen.

11.11.2 Causes and descriptions of transmission errors

The slave discards the query and does not return a response if any of the following transmission errors is detected.

Transmission error	Description
Framing error	Stop bit 0 was detected.
Parity error	A mismatch with the specified parity was detected.
Mismatched CRC	The calculated value of CRC-16 was found not matching the error check value.
Invalid message length	The message length exceeded 256 bytes.

11.11.3 Alarms related to RS-485 communication

If an alarm related to RS-485 communication is generated, the motor will stop operating and the PWR/ALM LED on the driver will blink in red.

Alarm code	Alarm type	Description
84h	RS-485 communication error	The RS-485 communication error alarm is generated when the RS-485 communication error consecutively occurs by the number of times set in the "RS-485 communication error alarm" parameter. Only the RS-485 communication error of communication errors is counted, and the number of times counted is not increased when other communication errors occur. When the communication is performed properly, the number of times that has counted is reset.
85h	RS-485 communication timeout	An alarm is generated when the time set in the "RS-485 communication timeout alarm" parameter has elapsed and yet the communication is not established with the host controller. When RS-485 communication is performed properly, the time that has counted is reset.

11.11.4 Information related to RS-485 communication

If information related to RS-485 communication is generated, the motor will continue operating and the PWR/ALM LED on the driver will blink in orange.

- **RS-485 communication error information**

The RS-485 communication error information is generated when the RS-485 communication error consecutively occurs by the number of times set in the "RS-485 communication error information" parameter. Only the RS-485 communication error of communication errors is counted, and the number of times counted is not increased when other communication errors occur. When the communication is performed properly, the number of times that has counted is reset.

12 Addresses and codes list

12.1 Timing for parameter to update

All data used by the driver is 32-bit wide. The register for the Modbus protocol is 16-bit wide, and one data is described by two registers.

When a parameter is set via RS-485 communication, they are saved in the RAM. Parameters saved in the RAM is cleared if the power supply is turned off. Parameters saved in the non-volatile memory are stored even after the power supply is turned off.

When the power supply of the driver is turned on, the parameters stored in the non-volatile memory will be sent to the RAM, and the recalculation and setup for the parameters will be executed in the RAM.

To save the parameters stored in the RAM to the non-volatile memory, execute the "Write batch NV memory" of the maintenance command.

Parameters having set with the **MEXE02** are saved in the non-volatile memory if "data writing" is performed.

When a parameter is changed, the timing to update the new value varies depending on the parameter. See the following four types.

- Update immediately..... Recalculation and setup are immediately executed when the parameter is written.
- Update after operation stop..... Recalculation and setup are executed when the operation is stopped.
- Update after executing configuration Recalculation and setup are executed after configuration is executed.
- Update after turning on the power again Recalculation and setup are executed after the power supply is turned on again.



- Parameters set via RS-485 communication are saved in the RAM. When changing a parameter that requires to turn on the power supply again to update data, be sure to save it in the non-volatile memory before turning off the power supply.
- The non-volatile memory can be rewritten approximately 100,000 times.

■ Notation rules

In this part, each update timing is represented in an alphabet.

A: Update immediately

B: Update after operation stop

C: Update after executing Configuration or turning on the power again

D: Update after turning on the power again

READ/WRITE may be represented as "R/W" in this part.

12.2 I/O commands

These are commands related to I/O. The set value is saved in the RAM.
For the status of remote I/O, direct I/O, and internal I/O, refer to p.109.

Modbus communication Register address		Name	Description	Initial value	R/W
Upper	Lower				
124 (007Ch)	125 (007Dh)	Driver input command	Sets the input command to the driver. Refer to the table below for details about arrangement of bits.	0	R/W

■ Driver input command

These are the driver input signals that can be accessed via RS-485 communication.
The driver input command can also be accessed in units of one register (16 bits).

● Remote input (upper): 124 (007Ch)

bit15	bit14	bit13	bit12	bit11	bit10	bit9	bit8
-	-	-	-	-	-	-	-
bit7	bit6	bit5	bit4	bit3	bit2	bit1	bit0
-	-	-	-	-	-	-	-

● Remote input (lower): 125 (007Dh)

bit15	bit14	bit13	bit12	bit11	bit10	bit9	bit8
R-IN15 [Not used]	R-IN14 [Not used]	R-IN13 [Not used]	R-IN12 [Not used]	R-IN11 [Not used]	R-IN10 [Not used]	R-IN9 [Not used]	R-IN8 [Not used]
bit7	bit6	bit5	bit4	bit3	bit2	bit1	bit0
R-IN7 [ALM-RST]	R-IN6 [Not used]	R-IN5 [FWD/REV]	R-IN4 [RUN/BRAKE]	R-IN3 [START/STOP]	R-IN2 [M2]	R-IN1 [M1]	R-IN0 [M0]

Values in brackets [] are initial values. The function to be assigned can be changed with the parameter setting.
Refer to p.48 for details about parameters and p.61 for details about input signals.



The driver input command can also be accessed in units of one register (16 bits).

12.3 Group command

This is a command related to group send. The set value is saved in the RAM.

Modbus communication Register address		Name	Description	Initial value	R/W
Upper	Lower				
48 (0030h)	49 (0031h)	Group ID	Set a group address to the child slaves to be included in the group. *1 [Setting range] -1: No group specification (group send is not performed) 1 to 15: The address (address of the parent slave) of the group	-1*2	R/W

*1 Do not set "0" to the group ID.

*2 The initial value can be changed using the "Initial group ID" parameter.



If the power supply is turned off, the setting value of the group ID is returned to the initial value and the group will be released.

If the group function is needed to use immediately when the power supply is turned on, set using the "Initial group ID" parameter.

12.4 Protect release commands

The key code to release the function limitation by the HMI input is set.
Write the HMI release key to the target address.

Modbus communication Register address		Name	Description	Initial value	R/W
Upper	Lower				
68 (0044h)	69 (0045h)	HMI release key	Inputs the key code to release the limitation by the HMI input.	0	R/W

● Key code table

Command name	Key code
HMI release key	864617234 (3389 0312h)

12.5 Maintenance commands

Maintenance commands are used to execute resetting alarms, batch processing of the non-volatile memory or the like.
All maintenance commands are write-only.



The maintenance command includes a process in which the memory is operated. Be careful not to execute them unnecessarily in succession.

Modbus communication Register address		Name	Description
Upper	Lower		
384 (0180h)	385 (0181h)	Alarm reset	Resets the alarm being generated presently. Some alarms cannot be reset with the "alarm reset."
388 (0184h)	389 (0185h)	Clear alarm history	Clears the alarm history.
392 (0188h)	393 (0189h)	Clear communication error history	Clears the communication error history.
396 (018Ch)	397 (018Dh)	Configuration	Executes the parameter recalculation and the setup. (About configuration, refer to p.105)
398 (018Eh)	399 (018Fh)	Batch data initialization (excluding communication parameters)	Restores the parameters saved in the non-volatile memory to their initial values. (Excluding parameters related to communication setting*1)
400 (0190h)	401 (0191h)	Read batch NV memory	Reads the parameters saved in the non-volatile memory to the RAM. All operation data and parameters previously saved in the RAM are overwritten.
402 (0192h)	403 (0193h)	Write batch NV memory	Writes the parameters saved in the RAM to the non-volatile memory. The non-volatile memory can be rewritten approximately 100,000 times.
404 (0194h)	405 (0195h)	All data batch initialization (including communication parameters)	Restores all parameters saved in the non-volatile memory to their initial values.
414 (019Eh)	415 (019Fh)	Clear tripmeter	Clears the tripmeter.
422 (01A6h)	423 (01A7h)	Clear information	Clears the information. This is used when the "Information auto clear" parameter is set to "Disable."
424 (01A8h)	425 (01A9h)	Clear information history	Clears information history.
426 (01AAh)	427 (01ABh)	Alarm history details	Write a history number (1 to 10) to check in the alarm history details. When the "Alarm history details" of the monitor command is executed after writing, the detailed items of the specified alarm history can be checked. *2
428 (01ACh)	429 (01ADh)	External stop	Stops the motor forcibly. An external stop alarm is generated when the motor stops.
430 (01AEh)	431 (01AFh)	Clear rotation amount meter	Clears the rotation amount meter.

*1 Refer to "Parameters updated when turning on the power" on p.86 for the parameters applied.

*2 The driver status when an alarm is generated can be checked. Refer to the alarm related commands of the monitor commands for items that can be checked.

■ Configuration

Configuration can be executed when all of the following conditions are satisfied:

- An alarm is not present
- The motor is not operated
- I/O test, teaching/remote operation, and download are not being performed with the **MEXE02**.

The table below shows the driver status before and after configuration is executed.

Item	Configuration is ready to execute	Configuration is executing	After configuration is executed
PWR/ALM LED	Lit in green	Blink in orange (Red and green colors may overlap and it may be visible to orange.)	Lit in green
Output signals	Allowed	Not allowed	Allowed
Input signals	Allowed	Not allowed	Allowed



The correct monitor value may not return even if the monitor is executed while configuration is being executed.

12.5.1 How to execute the maintenance commands

■ To execute via Modbus communication

There are two types of execution methods. Use them selectively in accordance with the intended use.

● Write "1" to data (Recommended)

Write "1" to data, and when the data changes from "0" to "1," the command is executed.

When executing the same command again, once return to "0," and write "1." It can be used with safety because the command is not executed consecutively even if "1" is continued to write from the master controller.

● Write "2" to data

If "2" is written to data, the command is executed. It will automatically return to "1" after the execution. The data can be written consecutively because of no need to be returned to "0."

If commands which take time to write to the non-volatile memory such as "Write batch NV memory" command are executed consecutively, increase the length of the intervals between commands.



Only the "Alarm history details" command is an exception. Write the alarm history number to be checked with the "Alarm history details" of the monitor command.

The following maintenance commands may not be completed at the time of sending the response.

To check that a command is completed, check that the SYS-BSY has been turned from ON to OFF.

- Configuration
- Batch data initialization
- All data batch initialization
- Read batch NV memory
- Write batch NV memory

12.6 Monitor commands

These commands are used to monitor the operation data, alarm and information histories, etc. All commands are read-only.

■ Alarm related commands

These are monitor commands related to alarms.

Modbus communication Register address		Name	Description
Upper	Lower		
128 (0080h)	129 (0081h)	Present alarm	Monitors the alarm code presently being generated.
130 (0082h)	131 (0083h)	Alarm history 1	Monitors the latest alarm history. When an alarm is being generated, the alarm code presently being generated is indicated.

Modbus communication Register address		Name	Description
Upper	Lower		
132 (0084h)	133 (0085h)	Alarm history 2	Monitors the alarm history.
134 (0086h)	135 (0087h)	Alarm history 3	
136 (0088h)	137 (0089h)	Alarm history 4	
138 (008Ah)	139 (008Bh)	Alarm history 5	
140 (008Ch)	141 (008Dh)	Alarm history 6	
142 (008Eh)	143 (008Fh)	Alarm history 7	
144 (0090h)	145 (0091h)	Alarm history 8	
146 (0092h)	147 (0093h)	Alarm history 9	
148 (0094h)	149 (0095h)	Alarm history 10	
2560 (0A00h)	2561 (0A01h)	Alarm history details (Alarm code)	Monitors the alarm code of the alarm having been generated. *1
2564 (0A04h)	2565 (0A05h)	Alarm history details (Driver temperature)	Monitors the driver temperature when an alarm was generated. (1=1°C)*1
2568 (0A08h)	2569 (0A09h)	Alarm history details (Inverter voltage)	Monitors the internal voltage when an alarm was generated. (1=0.1 V)*1
2570 (0A0Ah)	2571 (0A0Bh)	Alarm history details (Direct input)	Monitors the status of the direct input when an alarm was generated. *1*2
2572 (0A0Ch)	2573 (0A0Dh)	Alarm history details (Internal I/O)	Monitors the status of the internal I/O when an alarm was generated. *1*2
2574 (0A0Eh)	2575 (0A0Fh)	Alarm history details (Selection number)	Monitors the operation data number selected when an alarm was generated. *1
2580 (0A14h)	2581 (0A15h)	Alarm history details (Elapsed time from Boot)	Monitors the elapsed time until an alarm was generated from when the power was turned on. (1=1 ms)*1
2582 (0A16h)	2583 (0A17h)	Alarm history details (Elapsed time from starting operation)	Monitors the elapsed time until an alarm was generated from the start of operation if operation was being performed when an alarm was generated. (1=1 ms)*1
2584 (0A18h)	2585 (0A19h)	Alarm history details (Main power supply time)	Monitors the cumulative elapsed time until an alarm was generated from when the main power supply was first time turned on in minute. (1=1 min)*1
2586 (0A1Ah)	2587 (0A1Bh)	Alarm history details (Command speed)	Monitors the command speed when an alarm was generated. (1=1 r/min)*1
2588 (0A1Ch)	2589 (0A1Dh)	Alarm history details (Feedback speed)	Monitors the feedback speed when an alarm was generated. (1=1 r/min)*1
2590 (0A1Eh)	2591 (0A1Fh)	Alarm history details (Load factor)	Monitors the load factor when an alarm was generated. (1=1%)*1*3
2658 (0A62h)	2659 (0A63h)	Alarm history details (Remote input)	Monitors the status of the remote input when an alarm was generated. *1*2

- *1 It indicates the description of the alarm history specified by the "Alarm history details" of the maintenance command. Refer to p.136 for details about the alarm history. When the "Alarm history details" is not executed, the present alarm status can be checked. (If an alarm is not generated, the data is "0.")
- *2 Refer to p.136 for the bit arrangement.
- *3 It is a value based on the rated torque being 100%.

■ Information related commands

These are monitor commands related to information.

Modbus communication Register address		Name	Description
Upper	Lower		
246 (00F6h)	247 (00F7h)	Information	Monitors the information code presently being generated. *
2592 (0A20h)	2593 (0A21h)	Information history 1	Monitors the latest information history. When information is being generated, the information code presently being generated is indicated.
2594 (0A22h)	2595 (0A23h)	Information history 2	Monitors the information history.
2596 (0A24h)	2597 (0A25h)	Information history 3	
2598 (0A26h)	2599 (0A27h)	Information history 4	
2600 (0A28h)	2601 (0A29h)	Information history 5	
2602 (0A2Ah)	2603 (0A2Bh)	Information history 6	
2604 (0A2Ch)	2605 (0A2Dh)	Information history 7	
2606 (0A2Eh)	2607 (0A2Fh)	Information history 8	
2608 (0A30h)	2609 (0A31h)	Information history 9	
2610 (0A32h)	2611 (0A33h)	Information history 10	
2612 (0A34h)	2613 (0A35h)	Information history 11	
2614 (0A36h)	2615 (0A37h)	Information history 12	
2616 (0A38h)	2617 (0A39h)	Information history 13	
2618 (0A3Ah)	2619 (0A3Bh)	Information history 14	
2620 (0A3Ch)	2621 (0A3Dh)	Information history 15	
2622 (0A3Eh)	2623 (0A3Fh)	Information history 16	Monitors the oldest information history.
2624 (0A40h)	2625 (0A41h)	Information time history 1	Monitors the time when the latest information was generated. When information is being generated, the time when the present information was generated is indicated. (1=1 ms)
2626 (0A42h)	2627 (0A43h)	Information time history 2	Monitors the time when information was generated. (1=1 ms)
2628 (0A44h)	2629 (0A45h)	Information time history 3	
2630 (0A46h)	2631 (0A47h)	Information time history 4	
2632 (0A48h)	2633 (0A49h)	Information time history 5	
2634 (0A4Ah)	2635 (0A4Bh)	Information time history 6	
2636 (0A4Ch)	2637 (0A4Dh)	Information time history 7	
2638 (0A4Eh)	2639 (0A4Fh)	Information time history 8	

* Refer to p.142 for details about the information code.

Modbus communication Register address		Name	Description
Upper	Lower		
2640 (0A50h)	2641 (0A51h)	Information time history 9	Monitors the time when information was generated. (1=1 ms)
2642 (0A52h)	2643 (0A53h)	Information time history 10	
2644 (0A54h)	2645 (0A55h)	Information time history 11	
2646 (0A56h)	2647 (0A57h)	Information time history 12	
2648 (0A58h)	2649 (0A59h)	Information time history 13	
2650 (0A5Ah)	2651 (0A5Bh)	Information time history 14	
2652 (0A5Ch)	2653 (0A5Dh)	Information time history 15	
2654 (0A5Eh)	2655 (0A5Fh)	Information time history 16	Monitors the time when the oldest information was generated. (1=1 ms)

■ Operation data related commands

These are monitor commands related to operation data.

Modbus communication Register address		Name	Description
Upper	Lower		
196 (00C4h)	197 (00C5h)	Selection number	Monitors the operation data number presently selected. When an operation such as teaching/remote operation that does not use the operation data is being executed, "-1" is indicated.
3236 (0CA4h)	3237 (0CA5h)	Rotation speed setting value	Monitors the setting value of the rotation speed for the operation data number presently selected. (1=1 r/min)
3238 (0CA6h)	3239 (0CA7h)	Acceleration time setting value	Monitors the setting value of the acceleration time for the operation data number presently selected. (1=0.1 s)
3240 (0CA8h)	3241 (0CA9h)	Deceleration time setting value	Monitors the setting value of the deceleration time for the operation data number presently selected. (1=0.1 s)
3242 (0CAAh)	3243 (0CABh)	Torque limiting setting value	Monitors the setting value of the torque limiting function for the operation data number presently selected. (1=1%)

■ Driver status

These are monitor commands related to driver status.

Modbus communication Register address		Name	Description
Upper	Lower		
200 (00C8h)	201 (00C9h)	Command Speed	Monitors the present command speed. (1=1 r/min)
206 (00CEh)	207 (00CFh)	Feedback speed	Monitors the present feedback speed. (1=1 r/min)
216 (00D8h)	217 (00D9h)	Load factor	Monitors the present load factor. (1=1%)*
248 (00F8h)	249 (00F9h)	Driver temperature	Monitors the present driver temperature. (1=0.1 °C)
252 (00FCh)	253 (00FDh)	Odometer	Monitors the cumulative rotation amount inside the driver. (1=0.1 kRev) This cannot be cleared on the customer side.
254 (00FEh)	255 (00FFh)	Tripmeter	Monitors the cumulative rotation amount inside the driver. (1=0.1 kRev) This can be cleared on the customer side.
314 (013Ah)	315 (013Bh)	Rotation amount meter	Monitors the rotation amount meter. (1=1 rev)
320 (0140h)	321 (0141h)	Main power supply count	Monitors the number of times when the main power supply was turned on. (1=1 time)
322 (0142h)	323 (0143h)	Main power supply time	Monitors the cumulative time that has elapsed since the main power supply was turned on first time. (1=1 min)
326 (0146h)	327 (0147h)	Inverter voltage	Monitors the present voltage value inside the driver. (1=0.1 V)
338 (0152h)	339 (0153h)	Elapsed time from BOOT	Monitors the time that has elapsed since the power supply was turned on. (1=1 ms)

* It indicates based on the rated torque being 100%.

■ I/O related commands

These are monitor commands related to I/O. Refer to p.103 for checking the setting value of the remote input. Refer to the "I/O signals assignment list" (p.124) when checking the bit based on the signal name.

Modbus communication Register address		Name	Description
Upper	Lower		
126 (007Eh)	127 (007Fh)	Remote output	Monitors the output status of the remote output.
212 (00D4h)	213 (00D5h)	Direct I/O	Monitors the output status of the direct I/O.
368 (0170h)	369 (0171h)	I/O status 1	Monitors the ON-OFF status of the internal I/O.
370 (0172h)	371 (0173h)	I/O status 2	
372 (0174h)	373 (0175h)	I/O status 3	
374 (0176h)	375 (0177h)	I/O status 4	
376 (0178h)	377 (0179h)	I/O status 5	
378 (017Ah)	379 (017Bh)	I/O status 6	
380 (017Ch)	381 (017Dh)	I/O status 7	
382 (017Eh)	383 (017Fh)	I/O status 8	

● Remote output (upper): 126 (007Eh)

bit15	bit14	bit13	bit12	bit11	bit10	bit9	bit8
-	-	-	-	-	-	-	-
bit7	bit6	bit5	bit4	bit3	bit2	bit1	bit0
-	-	-	-	-	-	-	-

● Remote output (lower): 127 (007Fh)

bit15	bit14	bit13	bit12	bit11	bit10	bit9	bit8
R-OUT15 [TLC]	R-OUT14 [VA]	R-OUT13 [MOVE]	R-OUT12 [Not used]	R-OUT11 [Not used]	R-OUT10 [MPS]	R-OUT9 [DIR]	R-OUT8 [SYS-BSY]
bit7	bit6	bit5	bit4	bit3	bit2	bit1	bit0
R-OUT7 [ALM-A]	R-OUT6 [INFO]	R-OUT5 [FWD/REV_R]	R-OUT4 [RUN/BRAKE_R]	R-OUT3 [START/STOP_R]	R-OUT2 [M2_R]	R-OUT1 [M1_R]	R-OUT0 [M0_R]

Values in brackets [] are initial values.

● Direct I/O status (upper): 212 (00D4h)

bit15	bit14	bit13	bit12	bit11	bit10	bit9	bit8
-	-	-	-	-	-	-	-
bit7	bit6	bit5	bit4	bit3	bit2	bit1	bit0
-	-	-	-	-	-	D-OUT1	D-OUT0

● Direct I/O status (lower): 213 (00D5h)

bit15	bit14	bit13	bit12	bit11	bit10	bit9	bit8
-	-	-	-	-	-	-	-
bit7	bit6	bit5	bit4	bit3	bit2	bit1	bit0
-	-	-	D-IN4	D-IN3	D-IN2	D-IN1	D-IN0

● I/O status 1 (upper): 368 (0170h)

bit15	bit14	bit13	bit12	bit11	bit10	bit9	bit8
-	-	-	-	-	-	EXT-ERROR	-
bit7	bit6	bit5	bit4	bit3	bit2	bit1	bit0
-	TL	-	-	-	-	-	HMI

● I/O status 1 (lower): 369 (0171h)

bit15	bit14	bit13	bit12	bit11	bit10	bit9	bit8
-	INFO-CLR	-	-	-	-	-	ALM-RST
bit 7	bit6	bit5	bit4	bit3	bit2	bit1	bit0
-	-	-	-	-	-	-	-

● I/O status 2 (upper): 370 (0172h)

bit15	bit14	bit13	bit12	bit11	bit10	bit9	bit8
-	-	-	-	REV (RUN/BRAKE)	FWD (START/STOP)	-	-
bit7	bit6	bit5	bit4	bit3	bit2	bit1	bit0
-	-	-	-	-	-	-	-

● I/O status 2 (lower): 371 (0173h)

bit15	bit14	bit13	bit12	bit11	bit10	bit9	bit8
-	-	-	-	-	-	-	-
bit7	bit6	bit5	bit4	bit3	bit2	bit1	bit0
-	-	-	-	-	-	-	-

● I/O status 3 (upper): 372 (0174h)

bit15	bit14	bit13	bit12	bit11	bit10	bit9	bit8
Reserved	Reserved	Reserved	Reserved	Reserved	Reserved	Reserved	Reserved
bit7	bit6	bit5	bit4	bit3	bit2	bit1	bit0
Reserved	Reserved	Reserved	Reserved	R3	R2	R1	R0

"0" is entered in the reserved field.

● I/O status 3 (lower): 373 (0175h)

bit15	bit14	bit13	bit12	bit11	bit10	bit9	bit8
-	-	-	-	-	H-FREE	Reserved	STOP-MODE (FWD/REV)
bit7	bit6	bit5	bit4	bit3	bit2	bit1	bit0
-	-	-	-	-	M2	M1	M0

"0" is entered in the reserved field.

● I/O status 4 (upper): 374 (0176h)

bit15	bit14	bit13	bit12	bit11	bit10	bit9	bit8
-	-	-	-	-	-	-	-
bit7	bit6	bit5	bit4	bit3	bit2	bit1	bit0
-	-	-	-	-	-	-	-

● I/O status 4 (lower): 375 (0177h)

bit15	bit14	bit13	bit12	bit11	bit10	bit9	bit8
-	-	-	-	-	-	-	-
bit7	bit6	bit5	bit4	bit3	bit2	bit1	bit0
-	-	-	-	-	-	-	-

● I/O status 5 (upper): 376 (0178h)

bit15	bit14	bit13	bit12	bit11	bit10	bit9	bit8
-	-	-	-	-	-	-	-
bit7	bit6	bit5	bit4	bit3	bit2	bit1	bit0
-	-	-	DIR	SPEED-OUT*	-	-	-

* The SPEED-OUT output is a signal to be turned ON and OFF repeatedly. Therefore, it may not match the internal I/O status depending on the acquisition timing.

● I/O status 5 (lower): 377 (0179h)

bit15	bit14	bit13	bit12	bit11	bit10	bit9	bit8
-	-	VA	TLC	-	-	-	SYS-BSY
bit 7	bit6	bit5	bit4	bit3	bit2	bit1	bit0
INFO	MOVE	-	-	-	ALM-B	ALM-A	-

● I/O status 6 (upper): 378 (017Ah)

bit15	bit14	bit13	bit12	bit11	bit10	bit9	bit8
-	-	-	-	-	-	-	-
bit7	bit6	bit5	bit4	bit3	bit2	bit1	bit0
-	-	-	-	-	-	-	-

● I/O status 6 (lower): 379 (017Bh)

bit15	bit14	bit13	bit12	bit11	bit10	bit9	bit8
-	-	-	-	-	-	-	MPS
bit7	bit6	bit5	bit4	bit3	bit2	bit1	bit0
-	-	-	-	-	-	-	-

● I/O status 7 (upper): 380 (017Ch)

bit15	bit14	bit13	bit12	bit11	bit10	bit9	bit8
-	-	-	-	-	-	-	-
bit7	bit6	bit5	bit4	bit3	bit2	bit1	bit0
-	-	-	-	-	-	-	-

● I/O status 7 (lower): 381 (017Dh)

bit15	bit14	bit13	bit12	bit11	bit10	bit9	bit8
-	-	-	-	-	-	-	-
bit7	bit6	bit5	bit4	bit3	bit2	bit1	bit0
-	-	-	-	-	-	-	-

● I/O status 8 (upper): 382 (017Eh)

bit15	bit14	bit13	bit12	bit11	bit10	bit9	bit8
INFO-RBT	INFO-CFG	INFO-IOTEST	INFO-DSLMTD	INFO-PCOUNT	INFO-PTIME	INFO-SPD-DE	INFO-TRQ-DE
bit7	bit6	bit5	bit4	bit3	bit2	bit1	bit0
-	-	INFO-ODO	INFO-TRIP	INFO-REV	-	-	-

● I/O status 8 (lower): 383 (017Fh)

bit15	bit14	bit13	bit12	bit11	bit10	bit9	bit8
INFO-NET-E	-	-	INFO-DRV	-	-	INFO-SET-E	INFO-SPD
bit7	bit6	bit5	bit4	bit3	bit2	bit1	bit0
INFO-LOAD	-	INFO-UVOLT	INFO-OVOLT	-	INFO-DRVTMP	-	Reserved

"0" is entered in the reserved field.

■ Communication related commands

These are monitor commands related to communication.

Modbus communication Register address		Name	Description
Upper	Lower		
172 (00ACh)	173 (00ADh)	Communication error	Monitors the communication error code received last time.
174 (00AEh)	175 (00AFh)	Communication error history 1	Monitors the latest communication error code history.
176 (00B0h)	177 (00B1h)	Communication error history 2	Monitors the communication error code history.
178 (00B2h)	179 (00B3h)	Communication error history 3	
180 (00B4h)	181 (00B5h)	Communication error history 4	
182 (00B6h)	183 (00B7h)	Communication error history 5	
184 (00B8h)	185 (00B9h)	Communication error history 6	
186 (00BAh)	187 (00BBh)	Communication error history 7	
188 (00BCh)	189 (00BDh)	Communication error history 8	
190 (00BEh)	191 (00BFh)	Communication error history 9	
192 (00C0h)	193 (00C1h)	Communication error history 10	Monitors the oldest communication error code history.
332 (014Ch)	333 (014Dh)	Address number setting switch	Monitors the status of the address number setting switch (ID).
336 (0150h)	337 (0151h)	RS-485 communication Reception frame counter	Monitors the number of frames received. The target to count the number of frames received can be selected using the "RS-485 Receive packet monitor" parameter.
344 (0158h)	345 (0159h)	RS-485 communication Normal reception frame counter (All)	Monitors the number of normal frames received.
346 (015Ah)	347 (015Bh)	RS-485 communication Normal reception frame counter (Only own address)	Monitors the number of normal frames received to own address.
348 (015Ch)	349 (015Dh)	RS-485 communication Abnormal reception frame counter (All)	Monitors the number of abnormal frames received.
350 (015Eh)	351 (015Fh)	RS-485 communication Transmission frame counter	Monitors the number of frames transmitted.
340 (0154h)	341 (0155h)	RS-485 communication Reception byte counter	Monitors the number of bytes received.
342 (0156h)	343 (0157h)	RS-485 communication Transmission byte counter	Monitors the number of bytes transmitted.
352 (0160h)	353 (0161h)	RS-485 communication Register write abnormal counter	Monitors the number of times that the received data is abnormal (outside setting range, command execute disable, etc.).

■ External setting device related commands

These are monitor commands related to the external setting device.

Modbus communication Register address		Name	Description
Upper	Lower		
302 (012Eh)	303 (012Fh)	External analog voltage	Monitors the input voltage of the external analog setting device presently input. (1=0.1 V)
310 (0136h)	311 (0137h)	PWM signal input duty cycle	Monitors the duty cycle of the PWM signal presently input. (1=0.1%)
312 (0138h)	313 (0139h)	PWM signal input frequency	Monitors the frequency of the PWM signal presently input. (1=0.1 kHz)

12.7 Operation data commands

Operation data that can be set is four items, rotation speed, torque limiting value, acceleration time, and deceleration time.

Addresses are grouped for each setting item. Check the indirect reference function if summarized based on the operation data number. (p.87)

Modbus communication Register address		Name	Setting range	Initial value	Update
Upper	Lower				
1152 (0480h)	1153 (0481h)	Operation data No.0 rotation speed	0, 80 to 3150 r/min	0	
1154 (0482h)	1155 (0483h)	Operation data No.1 rotation speed			
1156 (0484h)	1157 (0485h)	Operation data No.2 rotation speed			
1158 (0486h)	1159 (0487h)	Operation data No.3 rotation speed			
1160 (0488h)	1161 (0489h)	Operation data No.4 rotation speed			
1162 (048Ah)	1163 (048Bh)	Operation data No.5 rotation speed			
1164 (048Ch)	1165 (048Dh)	Operation data No.6 rotation speed			
1166 (048Eh)	1167 (048Fh)	Operation data No.7 rotation speed			
1792 (0700h)	1793 (0701h)	Operation data No.0 torque limiting value	0 to 200%	200	A
1794 (0702h)	1795 (0703h)	Operation data No.1 torque limiting value			
1796 (0704h)	1797 (0705h)	Operation data No.2 torque limiting value			
1798 (0706h)	1799 (0707h)	Operation data No.3 torque limiting value			
1800 (0708h)	1801 (0709h)	Operation data No.4 torque limiting value			
1802 (070Ah)	1803 (070Bh)	Operation data No.5 torque limiting value			
1804 (070Ch)	1805 (070Dh)	Operation data No.6 torque limiting value			
1806 (070Eh)	1807 (070Fh)	Operation data No.7 torque limiting value			
1536 (0600h)	1537 (0601h)	Operation data No.0 acceleration time	1 to 150 (1=0.1 s)	5	
1538 (0602h)	1539 (0603h)	Operation data No.1 acceleration time			
1540 (0604h)	1541 (0605h)	Operation data No.2 acceleration time			
1542 (0606h)	1543 (0607h)	Operation data No.3 acceleration time			
1544 (0608h)	1545 (0609h)	Operation data No.4 acceleration time			
1546 (060Ah)	1547 (060Bh)	Operation data No.5 acceleration time			
1548 (060Ch)	1549 (060Dh)	Operation data No.6 acceleration time			
1550 (060Eh)	1551 (060Fh)	Operation data No.7 acceleration time			

Modbus communication Register address		Name	Setting range	Initial value	Update
Upper	Lower				
1664 (0680h)	1665 (0681h)	Operation data No.0 deceleration time	1 to 150 (1=0.1 s)	5	A
1666 (0682h)	1667 (0683h)	Operation data No.1 deceleration time			
1668 (0684h)	1669 (0685h)	Operation data No.2 deceleration time			
1670 (0686h)	1671 (0687h)	Operation data No.3 deceleration time			
1672 (0688h)	1673 (0689h)	Operation data No.4 deceleration time			
1674 (068Ah)	1675 (068Bh)	Operation data No.5 deceleration time			
1676 (068Ch)	1677 (068Dh)	Operation data No.6 deceleration time			
1678 (068Eh)	1679 (068Fh)	Operation data No.7 deceleration time			

The setting method for the rotation speed and the torque limiting value can be changed to the external analog setting device or PWM signal input.

Modbus communication Register address		Name	Setting range	Initial value	Update
Upper	Lower				
1920 (0780h)	1921 (0781h)	Operation data No.0 rotation speed setting method	0: Digital setting 3: External analog setting device/PWM signal input	0	B
1922 (0782h)	1923 (0783h)	Operation data No.1 rotation speed setting method			
1924 (0784h)	1925 (0785h)	Operation data No.2 rotation speed setting method			
1926 (0786h)	1927 (0787h)	Operation data No.3 rotation speed setting method			
1928 (0788h)	1929 (0789h)	Operation data No.4 rotation speed setting method			
1930 (078Ah)	1931 (078Bh)	Operation data No.5 rotation speed setting method			
1932 (078Ch)	1933 (078Dh)	Operation data No.6 rotation speed setting method			
1934 (078Eh)	1935 (078Fh)	Operation data No.7 rotation speed setting method			
2304 (0900h)	2305 (0901h)	Operation data No.0 torque limiting value setting method	0: Digital setting 3: External analog setting device/PWM signal input	0	B
2306 (0902h)	2307 (0903h)	Operation data No.1 torque limiting value setting method			
2308 (0904h)	2309 (0905h)	Operation data No.2 torque limiting value setting method			
2310 (0906h)	2311 (0907h)	Operation data No.3 torque limiting value setting method			
2312 (0908h)	2313 (0909h)	Operation data No.4 torque limiting value setting method			
2314 (090Ah)	2315 (090Bh)	Operation data No.5 torque limiting value setting method			
2316 (090Ch)	2317 (090Dh)	Operation data No.6 torque limiting value setting method			
2318 (090Eh)	2319 (090Fh)	Operation data No.7 torque limiting value setting method			

12.8 Parameter commands

These commands are used to read or write parameters. All commands can be read and written (READ/WRITE). Refer to p.32 for details about parameters.

12.8.1 Operation data extended setting

Modbus communication Register address		Name	Setting range	Initial value	Update
Upper	Lower				
4170 (104Ah)	4171 (104Bh)	Speed upper limit	80 to 3150 r/min	3150	B
4172 (104Ch)	4173 (104Dh)	Speed lower limit	80 to 3150 r/min	80	
3652 (0E44h)	3653 (0E45h)	Torque limiting maximum value	0 to 200%	200	
3688 (0E68h)	3689 (0E69h)	External setting method	0: External analog setting device 1: PWM signal input	0	C
3642 (0E3Ah)	3643 (0E3Bh)	External analog operation speed command gain	0 to 3150 r/min/V	640	A
3644 (0E3Ch)	3645 (0E3Dh)	External analog operation speed command offset	-1500 to +1500 r/min	0	
3646 (0E3Eh)	3647 (0E3Fh)	External analog torque limiting gain	0 to 200 %/V	43	
3648 (0E40h)	3649 (0E41h)	External analog torque limiting offset	-100 to +100%	0	

12.8.2 Operation and I/O action

Modbus communication Register address		Name	Setting range	Initial value	Update
Upper	Lower				
660 (0294h)	661 (0295h)	Impact softening filter	0: No filter 1: Filter 1 2: Filter 2	0	B
3668 (0E54h)	3669 (0E55h)	Deceleration mode selection	0: Deceleration stop 1 1: Deceleration stop 2 2: Deceleration stop 3	0	C
900 (0384h)	901 (0385h)	Motor rotation direction	0: +=CCW 1: +=CW	1	
3638 (0E36h)	3639 (0E37h)	Operation input mode selection	0: 2-Wire mode 1: 3-Wire mode	1	
3634 (0E32h)	3635 (0E33h)	VA detection width	1 to 400 r/min	200	A
4138 (102Ah)	4139 (102Bh)	Load holding function selection	0: Disable 1: Enable	0	C
4144 (1030h)	4145 (1031h)	Load holding torque limiting setting value	-1 to +50%	-1	A

12.8.3 Alarm and information settings

Modbus communication Register address		Name	Setting range	Initial value	Update
Upper	Lower				
768 (0300h)	769 (0301h)	Overload alarm detection time	1 to 100 (1=0.1 s)	100	A
828 (033Ch)	829 (033Dh)	Prevention of operation at power-on alarm	0: Disable 1: Enable	1	C
894 (037Eh)	895 (037Fh)	Information auto clear	0: Disable 1: Enable	1	A
832 (0340h)	833 (0341h)	Driver temperature information	40 to 85 °C	85	
854 (0356h)	855 (0357h)	Overvoltage information	180 to 380 (1=0.1 V)	380	
856 (0358h)	857 (0359h)	Undervoltage information	180 to 380 (1=0.1 V)	180	
844 (034Ch)	845 (034Dh)	Load information	0: Disable 1 to 200%	0	
836 (0344h)	837 (0345h)	Speed information	0: Disable 1 to 5200 r/min	0	
846 (034Eh)	847 (034Fh)	RS-485 communication error information	0: Disable 1 to 10 times	3	A
862 (035Eh)	863 (035Fh)	Tripmeter information	0: Disable 1 to 999,999,999 (1=0.1 kRev)	0	
864 (0360h)	865 (0361h)	Odometer information	0: Disable 1 to 999,999,999 (1=0.1 kRev)	0	
876 (036Ch)	877 (036Dh)	Main power supply time information	0: Disable 1 to 999,999,999 min	0	
878 (036Eh)	879 (036Fh)	Main power supply count information	0: Disable 1 to 999,999,999 time	0	
880 (0370h)	881 (0371h)	Rotation amount meter information (positive side)	-2,147,483,648 to +2,147,483,647 rev	+2,147,483,647	
882 (0372h)	883 (0373h)	Rotation amount meter information (negative side)	-2,147,483,648 to +2,147,483,647 rev	-2,147,483,648	
3908 (0F44h)	3909 (0F45h)	INFO action (Driver temperature information (INFO-DRVTMP))	0: INFO action is not applied • Information bit output: Applied • INFO output: Not applied • LED: Not applied 1: INFO action is applied • Information bit output: Applied • INFO output: Applied • LED: Applied	1	
3912 (0F48h)	3913 (0F49h)	INFO action (Overvoltage information (INFO-OVOLT))		1	
3914 (0F4Ah)	3915 (0F4Bh)	INFO action (Undervoltage information (INFO-UVOLT))		1	
3918 (0F4Eh)	3919 (0F4Fh)	INFO action (Load information (INFO-LOAD))		1	
3920 (0F50h)	3921 (0F51h)	INFO action (Speed information (INFO-SPD))		1	
3922 (0F52h)	3923 (0F53h)	INFO action (Operation data setting error information (INFO-SET-E))		1	
3928 (0F58h)	3929 (0F59h)	INFO action (Operation prohibited information (INFO-DRV))		1	
3934 (0F5Eh)	3935 (0F5Fh)	INFO action (RS-485 communication error information (INFO-NET-E))		1	
3942 (0F66h)	3943 (0F67h)	INFO action (Rotation amount meter information (INFO-REV))		1	
3944 (0F68h)	3945 (0F69h)	INFO action (Tripmeter information (INFO-TRIP))		1	
3946 (0F6Ah)	3947 (0F6Bh)	INFO action (Odometer information (INFO-ODO))		1	
3952 (0F70h)	3953 (0F71h)	INFO action (Torque limiting value setting error information (INFO-TRQ-DE))		1	
3954 (0F72h)	3955 (0F73h)	INFO action (Rotation speed setting error information (INFO-SPD-DE))		1	

Modbus communication Register address		Name	Setting range	Initial value	Update
Upper	Lower				
3956 (0F74h)	3957 (0F75h)	INFO action (Main power supply time information (INFO-PTIME))	0: INFO action is not applied • Information bit output: Applied • INFO output: Not applied • LED: Not applied 1: INFO action is applied • Information bit output: Applied • INFO output: Applied • LED: Applied	1	A
3958 (0F76h)	3959 (0F77h)	INFO action (Main power supply count information (INFO-PCOUNT))		1	
3960 (0F78h)	3961 (0F79h)	INFO action (Operation start limit mode information (INFO-DSLMTD))		1	
3962 (0F7Ah)	3963 (0F7Bh)	INFO action (I/O test mode information (INFO-IOTEST))		1	
3964 (0F7Ch)	3965 (0F7Dh)	INFO action (Configuration request information (INFO-CFG))		1	
3966 (0F7Eh)	3967 (0F7Fh)	INFO action (Power cycling request information (INFO-RBT))		1	

12.8.4 Monitor setting

Modbus communication Register address		Name	Setting range	Initial value	Update
Upper	Lower				
4066 (0FE2h)	4067 (0FE3h)	Speed reduction ratio	100 to 9999	100	A
4076 (0FECh)	4077 (0FEDh)	Speed reduction ratio digit setting	0: ×1 1: ×0.1 2: ×0.01	2	
4078 (0FEEh)	4079 (0FEFh)	Speed increasing ratio	100 to 200 (1=0.01)	100	

12.8.5 Direct-IN function selection (D-IN)

Modbus communication Register address		Name	Setting range	Initial value	Update
Upper	Lower				
4224 (1080h)	4225 (1081h)	D-IN0 input function selection	Refer to "Input signals list." (p.124)	58: FWD (START/STOP)*	C
4226 (1082h)	4227 (1083h)	D-IN1 input function selection		59: REV (RUN/BRAKE)*	
4228 (1084h)	4229 (1085h)	D-IN2 input function selection		72: STOP-MODE (FWD/REV)*	
4230 (1086h)	4231 (1087h)	D-IN3 input function selection		64: M0	
4232 (1088h)	4233 (1089h)	D-IN4 input function selection		8: ALM-RST	
4256 (10A0h)	4257 (10A1h)	D-IN0 input logic level setting		0: Not invert 1: Invert	
4258 (10A2h)	4259 (10A3h)	D-IN1 input logic level setting	0		
4260 (10A4h)	4261 (10A5h)	D-IN2 input logic level setting	0		
4262 (10A6h)	4263 (10A7h)	D-IN3 input logic level setting	0		
4264 (10A8h)	4265 (10A9h)	D-IN4 input logic level setting	0		

* If the "3-wire mode" is set with the "Operation input mode selection" parameter, the signal in the parentheses () will be applied.

12.8.6 Direct-OUT function setting (D-OUT)

Modbus communication Register address		Name	Setting range	Initial value	Update
Upper	Lower				
4288 (10C0h)	4289 (10C1h)	D-OUT0 output function selection	Refer to "Output signals list." (p.125)	147: SPEED-OUT	C
4290 (10C2h)	4291 (10C3h)	D-OUT1 output function selection		130: ALM-B	
4320 (10E0h)	4321 (10E1h)	D-OUT0 output logic level setting	0: Not invert 1: Invert	0	
4322 (10E2h)	4323 (10E3h)	D-OUT1 output logic level setting		0	

12.8.7 Remote-IN function setting (R-IN)

Modbus communication Register address		Name	Setting range	Initial value	Update
Upper	Lower				
4608 (1200h)	4609 (1201h)	R-IN0 input function selection	Refer to "Input signals list." (p.124)	64: M0	C
4610 (1202h)	4611 (1203h)	R-IN1 input function selection		65: M1	
4612 (1204h)	4613 (1205h)	R-IN2 input function selection		66: M2	
4614 (1206h)	4615 (1207h)	R-IN3 input function selection		58: FWD (START/STOP)*	
4616 (1208h)	4617 (1209h)	R-IN4 input function selection		59: REV (RUN/BRAKE)*	
4618 (120Ah)	4619 (120Bh)	R-IN5 input function selection		72: STOP-MODE (FWD/REV)*	
4620 (120Ch)	4621 (120Dh)	R-IN6 input function selection		0: Not used	
4622 (120Eh)	4623 (120Fh)	R-IN7 input function selection		8: ALM-RST	
4624 (1210h)	4625 (1211h)	R-IN8 input function selection		0: Not used	
4626 (1212h)	4627 (1213h)	R-IN9 input function selection		0: Not used	
4628 (1214h)	4629 (1215h)	R-IN10 input function selection		0: Not used	
4630 (1216h)	4631 (1217h)	R-IN11 input function selection		0: Not used	
4632 (1218h)	4633 (1219h)	R-IN12 input function selection		0: Not used	
4634 (121Ah)	4635 (121Bh)	R-IN13 input function selection		0: Not used	
4636 (121Ch)	4637 (121Dh)	R-IN14 input function selection		0: Not used	
4638 (121Eh)	4639 (121Fh)	R-IN15 input function selection	0: Not used		

* If the "3-wire mode" is set with the "Operation input mode selection" parameter, the signal in the parentheses () will be applied.

12.8.8 Remote-OUT function setting (R-OUT)

Modbus communication Register address		Name	Setting range	Initial value	Update
Upper	Lower				
4640 (1220h)	4641 (1221h)	R-OUT0 output function selection	Refer to "Output signals list." (p.125)	64: M0_R	C
4642 (1222h)	4643 (1223h)	R-OUT1 output function selection		65: M1_R	
4644 (1224h)	4645 (1225h)	R-OUT2 output function selection		66: M2_R	
4646 (1226h)	4647 (1227h)	R-OUT3 output function selection		58: FWD (START/STOP)_R*	
4648 (1228h)	4649 (1229h)	R-OUT4 output function selection		59: REV (RUN/BRAKE)_R*	
4650 (122Ah)	4651 (122Bh)	R-OUT5 output function selection		72: STOP-MODE (FWD/REV)_R*	
4652 (122Ch)	4653 (122Dh)	R-OUT6 output function selection		135: INFO	
4654 (122Eh)	4655 (122Fh)	R-OUT7 output function selection		129: ALM-A	
4656 (1230h)	4657 (1231h)	R-OUT8 output function selection		136: SYS-BSY	
4658 (1232h)	4659 (1233h)	R-OUT9 output function selection		148: DIR	
4660 (1234h)	4661 (1235h)	R-OUT10 output function selection		168: MPS	
4662 (1236h)	4663 (1237h)	R-OUT11 output function selection		0: Not used	
4664 (1238h)	4665 (1239h)	R-OUT12 output function selection		0: Not used	
4666 (123Ah)	4667 (123Bh)	R-OUT13 output function selection		134: MOVE	
4668 (123Ch)	4669 (123Dh)	R-OUT14 output function selection		141: VA	
4670 (123Eh)	4671 (123Fh)	R-OUT15 output function selection		140: TLC	

* If the "3-wire mode" is set with the "Operation input mode selection" parameter, the signal in the parentheses () will be applied.

12.8.9 Communication and I/F function

Modbus communication Register address		Name	Setting range	Initial value	Update
Upper	Lower				
996 (03E4h)	997 (03E5h)	USB-ID enable	0: Disable 1: Enable	1	D
998 (03E6h)	999 (03E7h)	USB-ID	0 to 999,999,999	0	
5110 (13F6h)	5111 (13F7h)	USB-PID	0 to 31	0	
5056 (13C0h)	5057 (13C1h)	RS-485 Receive packet monitor	0: All 1: Only own address	0	A
4992 (1380h)	4993 (1381h)	Communication ID	–1: The switch setting of the driver is followed 1 to 15: Slave address 1 to 15 ※ Do not use 0.	–1	D
4994 (1382h)	4995 (1383h)	Baudrate	0: 9,600 bps 1: 19,200 bps 2: 38,400 bps 3: 57,600 bps 4: 115,200 bps 5: 230,400 bps	4	
4996 (1384h)	4997 (1385h)	Communication order	0: Even Address-High Word & Big-Endian 1: Even Address-Low Word & Big-Endian 2: Even Address-High Word & Little-Endian 3: Even Address-Low Word & Little-Endian	0	
4998 (1386h)	4999 (1387h)	Communication parity	0: None 1: Even parity 2: Odd parity	1	
5000 (1388h)	5001 (1389h)	Communication stop bit	0: 1 bit 1: 2 bits	0	
5002 (138Ah)	5003 (138Bh)	RS-485 communication timeout	0: Not monitored 1 to 10000 ms	0	
5004 (138Ch)	5005 (138Dh)	RS-485 communication error alarm	0 to 10 times	3	
5006 (138Eh)	5007 (138Fh)	Transmission waiting time	0 to 10000 (1=0.1 ms)	30	D
5008 (1390h)	5009 (1391h)	Silent interval	0.0: Set automatically 1 to 100 (1=0.1 ms)	0.0	
5010 (1392h)	5011 (1393h)	Slave error response mode	0: Normal response is returned 1: Exception response is returned	1	A
5012 (1394h)	5013 (1395h)	Initial group ID	–1: Disable (no group transmission) 1 to 15: Group ID ※ Do not use 0.	–1	C

12.8.10 Indirect reference setting (address)

Modbus communication Register address		Name	Setting range	Initial value	Update
Upper	Lower				
4864 (1300h)	4865 (1301h)	Indirect reference address setting (0)	0 to 65,535 (0 to FFFFh)	576: Operation data No.0 rotation speed	A
4866 (1302h)	4867 (1303h)	Indirect reference address setting (1)		896: Operation data No.0 torque limiting value	
4868 (1304h)	4869 (1305h)	Indirect reference address setting (2)		768: Operation data No.0 acceleration time	
4870 (1306h)	4871 (1307h)	Indirect reference address setting (3)		832: Operation data No.0 deceleration time	
4872 (1308h)	4873 (1309h)	Indirect reference address setting (4)		62: Driver input command	
4874 (130Ah)	4875 (130Bh)	Indirect reference address setting (5)		98: Selection number	
4876 (130Ch)	4877 (130Dh)	Indirect reference address setting (6)		103: Feedback speed	
4878 (130Eh)	4879 (130Fh)	Indirect reference address setting (7)		108: Load factor	
4880 (1310h)	4881 (1311h)	Indirect reference address setting (8)		63: Remote output	
4882 (1312h)	4883 (1313h)	Indirect reference address setting (9)		64: Present alarm	
4884 (1314h)	4885 (1315h)	Indirect reference address setting (10)		123: Information	
4886 (1316h)	4887 (1317h)	Indirect reference address setting (11)		124: Driver temperature	
4888 (1318h)	4889 (1319h)	Indirect reference address setting (12)		163: Inverter voltage	
4890 (131Ah)	4891 (131Bh)	Indirect reference address setting (13)		157: Rotation amount meter	
4892 (131Ch)	4893 (131Dh)	Indirect reference address setting (14)		127: Tripmeter	
4894 (131Eh)	4895 (131Fh)	Indirect reference address setting (15)		126: Odometer	
4896 (1320h)	4897 (1321h)	Indirect reference address setting (16)		160: Main power supply count	
4898 (1322h)	4899 (1323h)	Indirect reference address setting (17)		161: Main power supply time	
4900 (1324h)	4901 (1325h)	Indirect reference address setting (18)		184: I/O status 1	
4902 (1326h)	4903 (1327h)	Indirect reference address setting (19)		185: I/O status 2	
4904 (1328h)	4905 (1329h)	Indirect reference address setting (20)		186: I/O status 3	
4906 (132Ah)	4907 (132Bh)	Indirect reference address setting (21)		187: I/O status 4	
4908 (132Ch)	4909 (132Dh)	Indirect reference address setting (22)		188: I/O status 5	
4910 (132Eh)	4911 (132Fh)	Indirect reference address setting (23)		189: I/O status 6	
4912 (1330h)	4913 (1331h)	Indirect reference address setting (24)		190: I/O status 7	
4914 (1332h)	4915 (1333h)	Indirect reference address setting (25)		191: I/O status 8	
4916 (1334h)	4917 (1335h)	Indirect reference address setting (26)		0: Not assigned	
4918 (1336h)	4919 (1337h)	Indirect reference address setting (27)	0: Not assigned		

Modbus communication Register address		Name	Setting range	Initial value	Update
Upper	Lower				
4920 (1338h)	4921 (1339h)	Indirect reference address setting (28)	0 to 65,535 (0 to FFFFh)	0: Not assigned	A
4922 (133Ah)	4923 (133Bh)	Indirect reference address setting (29)		0: Not assigned	
4924 (133Ch)	4925 (133Dh)	Indirect reference address setting (30)		0: Not assigned	
4926 (133Eh)	4927 (133Fh)	Indirect reference address setting (31)		0: Not assigned	

12.8.11 Indirect reference setting (area)

Modbus communication Register address		Name
Upper	Lower	
4928 (1340h)	4929 (1341h)	Indirect reference area (0)
4930 (1342h)	4931 (1343h)	Indirect reference area (1)
4932 (1344h)	4933 (1345h)	Indirect reference area (2)
4934 (1346h)	4935 (1347h)	Indirect reference area (3)
4936 (1348h)	4937 (1349h)	Indirect reference area (4)
4938 (134Ah)	4939 (134Bh)	Indirect reference area (5)
4940 (134Ch)	4941 (134Dh)	Indirect reference area (6)
4942 (134Eh)	4943 (134Fh)	Indirect reference area (7)
4944 (1350h)	4945 (1351h)	Indirect reference area (8)
4946 (1352h)	4947 (1353h)	Indirect reference area (9)
4948 (1354h)	4949 (1355h)	Indirect reference area (10)
4950 (1356h)	4951 (1357h)	Indirect reference area (11)
4952 (1358h)	4953 (1359h)	Indirect reference area (12)
4954 (135Ah)	4955 (135Bh)	Indirect reference area (13)
4956 (135Ch)	4957 (135Dh)	Indirect reference area (14)
4958 (135Eh)	4959 (135Fh)	Indirect reference area (15)

Modbus communication Register address		Name
Upper	Lower	
4960 (1360h)	4961 (1361h)	Indirect reference area (16)
4962 (1362h)	4963 (1363h)	Indirect reference area (17)
4964 (1364h)	4965 (1365h)	Indirect reference area (18)
4966 (1366h)	4967 (1367h)	Indirect reference area (19)
4968 (1368h)	4969 (1369h)	Indirect reference area (20)
4970 (136Ah)	4971 (136Bh)	Indirect reference area (21)
4972 (136Ch)	4973 (136Dh)	Indirect reference area (22)
4974 (136Eh)	4975 (136Fh)	Indirect reference area (23)
4976 (1370h)	4977 (1371h)	Indirect reference area (24)
4978 (1372h)	4979 (1373h)	Indirect reference area (25)
4980 (1374h)	4981 (1375h)	Indirect reference area (26)
4982 (1376h)	4983 (1377h)	Indirect reference area (27)
4984 (1378h)	4985 (1379h)	Indirect reference area (28)
4986 (137Ah)	4987 (137Bh)	Indirect reference area (29)
4988 (137Ch)	4989 (137Dh)	Indirect reference area (30)
4990 (137Eh)	4991 (137Fh)	Indirect reference area (31)

12.9 I/O signals assignment list

To assign signals via RS-485 communication, use the "Assignment number" in the table instead of the signal names.

12.9.1 Input signals list

Assignment number	Signal name	Monitor target	Address	Corresponding bit
0	Not used	–	–	–
8	ALM-RST	I/O status 1 (lower)	369 (0171h)	bit8
14	INFO-CLR			bit14
16	HMI	I/O status 1 (upper)	368 (0170h)	bit0
22	TL			bit6
25	EXT-ERROR*1			bit9
58	FWD (START/STOP)*2	I/O status 2 (upper)	370 (0172h)	bit10
59	REV (RUN/BRAKE)*2			bit11
64	M0	I/O status 3 (lower)	373 (0175h)	bit0
65	M1			bit1
66	M2			bit2
72	STOP-MODE (FWD/REV)*2			bit8
74	H-FREE			bit10
80	R0	I/O status 3 (upper)	372 (0174h)	bit0
81	R1			bit1
82	R2			bit2
83	R3			bit3

*1 The EXT-ERROR input cannot be assigned to the remote input.

*2 If the 3-wire mode is selected with the "Operation input mode selection" parameter, the signal in the parentheses () will be applied.

12.9.2 Output signals list

Assignment number	Signal name	Monitor target	Address	Corresponding bit
0	Not used	-	-	-
8	ALM-RST_R	I/O status 1 (lower)	369 (0171h)	bit8
14	INFO-CLR_R			bit14
16	HMI_R	I/O status 1 (upper)	368 (0170h)	bit0
22	TL_R			bit6
25	EXT-ERROR_R			bit9
58	FWD (START/STOP)_R*1	I/O status 2 (upper)	370 (0172h)	bit10
59	REV (RUN/BRAKE)_R*1			bit11
64	M0_R	I/O status 3 (lower)	373 (0175h)	bit0
65	M1_R			bit1
66	M2_R			bit2
72	STOP-MODE (FWD/REV)_R*1			bit8
74	H-FREE_R			bit10
80	R0_R	I/O status 3 (upper)	372 (0174h)	bit0
81	R1_R			bit1
82	R2_R			bit2
83	R3_R			bit3
129	ALM-A	I/O status 5 (lower)	377 (0179h)	bit1
130	ALM-B			bit2
134	MOVE			bit6
135	INFO			bit7
136	SYS-BSY			bit8
140	TLC			bit12
141	VA			bit13
147	SPEED-OUT*2	I/O status 5 (upper)	376 (0178h)	bit3
148	DIR			bit4
168	MPS	I/O status 6 (lower)	379 (017Bh)	bit8
226	INFO-DRVTMP	I/O status 8 (lower)	383 (017Fh)	bit2
228	INFO-OVOLT			bit4
229	INFO-UVOLT			bit5
231	INFO-LOAD			bit7
232	INFO-SPD			bit8
233	INFO-SET-E			bit9
236	INFO-DRV			bit12
239	INFO-NET-E			bit15
243	INFO-REV	I/O status 8 (upper)	382 (017Eh)	bit3
244	INFO-TRIP			bit4
245	INFO-ODO			bit5
248	INFO-TRQ-DE			bit8
249	INFO-SPD-DE			bit9
250	INFO-PTIME			bit10
251	INFO-PCOUNT			bit11
252	INFO-DSLMTD			bit12
253	INFO-IOTEST			bit13
254	INFO-CFG			bit14
255	INFO-RBT			bit15

*1 If the 3-wire mode is selected with the "Operation input mode selection" parameter, the signal in the parentheses () will be applied.

*2 The SPEED-OUT output cannot be assigned to the remote output.

13 MEXE02

The **MEXE02** is software to set the data required to operate the motor using a PC. Refer to the operating manual of the **MEXE02** for how to use such as data editing method and others. This chapter explains details about the **BLH** Series RS-485 communication type.

13.1 Starting MEXE02

Select the product.

Series: BLH

Product: BLH RS-485 communication type

13.2 Monitor

■ Unit information monitor

The unit information monitor is provided in the **MEXE02**.

If this monitor function is used, the driver information such as the number of times the main power supply is turned on and the cumulative time of power-on in addition to the product information such as the product name can be checked. The set values of parameters related to operation or communication can also be checked.

● How to view the unit information monitor window

Item	Description
Driver user name	A desired name can be given with the "Driver user name" parameter.
Product name	Monitors the driver model being connected to the MEXE02 .
Main power count	Monitors the number of times that the main power supply of the driver is turned on.
Main power supply time	Monitors the cumulative time that has elapsed since the main power supply was turned on first time.
Address number setting (ID)	Monitors the switch setting state.
Communication function	Monitors the descriptions of communication parameters set in the driver.
Driver setting value	Monitors the parameter values set in the driver.

■ Status monitor

The present status of the driver can be monitored.

● How to view the status monitor window

Main monitored items	Description
Command speed (motor shaft)	Monitors the present command speed.
Command speed (gearhead shaft)	Monitors the present command speed as a value converted by the set speed reduction ratio.
Actual speed (motor shaft)	Monitors the present feedback speed.
Actual speed (gearhead shaft)	Monitors the present feedback speed as a value converted by the set speed reduction ratio.
Inverter voltage	Monitors the present voltage value inside the driver.
Elapsed time from BOOT	Monitors the time that has elapsed since the power supply was turned on.
Load factor	Monitors the present motor output torque as a load factor. The load factor is a value based on the rated torque being 100%.
Driver temperature	Monitors the present driver temperature.
Selection number	Monitors the operation data number presently selected.
Operation data setting method	Monitors the setting method of each operation data (rotation speed, acceleration time, deceleration time, torque limiting value) presently selected.
Load holding torque limiting setting method	Monitors the setting method of the load holding torque limiting presently set.
External analog setting device (input voltage)*	Monitors the voltage value of the external analog setting device presently input.
Operation data setting value	Monitors the setting value of each operation data (rotation speed, acceleration time, deceleration time, torque limiting) presently selected.
Load holding torque limiting setting value	Monitors the load holding torque limiting value presently set.
PWM signal input (duty cycle)*	Monitors the duty cycle of the PWM signal presently input.
Tripmeter	Monitors the cumulative rotation amount inside the driver. The value of the tripmeter can be cleared by executing "Clear tripmeter."
Odometer	Monitors the cumulative rotation amount inside the driver since the driver was started operating.
Rotation amount meter	Monitors the rotation amount inside the driver. The value of the rotation amount meter can be cleared by executing "Clear rotation amount meter" or turning on the power again.
LED output	Monitors the output status of the LED.
Alarm	Monitors the present alarm status. Details of the alarm generated and the driver status when the alarm was generated can be checked using the alarm monitor.
Information	Monitors the present information status. Details of the information can be checked using the information monitor.
Communication error	Monitors the present communication error status. Details of the communication error can be checked using the RS-485 communication monitor.
Sequence history	Monitors the operation data numbers executed previously (the latest 16 data). "-" is displayed when the motor is stopped, and the value same as the selection number is displayed during operation. The sequence history can be cleared by executing "Clear sequence history."

* "-" is displayed if not selected in the "External setting method" parameter.

■ D-I/O, R-I/O monitor

D-I/O represents direct I/O, and R-I/O represents remote I/O.

In addition to the status of I/O signals of the driver, the setting values for the external analog setting device and the PWM signal input can be monitored.

● How to view the D-I/O, R-I/O monitor window

Monitored items	Description
Direct-I/O (D-I/O)	Monitors I/O signal names assigned to the direct I/O and the status of input/output to the direct I/O.
Remote-I/O (R-I/O)	Monitors I/O signal names assigned to the remote I/O and the status of input/output to the remote I/O.
External analog setting device *	Monitors the input voltage value of the external analog setting device.
PWM signal input *	Monitors the duty cycle and the frequency of the PWM signal input.

* "-" is displayed if not selected in the "External setting method" parameter.

■ Internal I/O monitor

All I/O signals of the driver and the hall sensor signal detected in the driver can be monitored.

Signals that are not assigned to direct I/O and remote I/O can also be checked.



Hall sensor signals (HA, HB, HC) cannot be assigned to direct I/O and remote I/O.

■ Alarm monitor

The alarm history of the driver can be checked, and also resetting the alarm and clearing the alarm history can be executed.

The alarm history can be checked up to 10 items in order of the latest to oldest.

● Items that can be checked in the alarm history

Item	Description
Code (Hex)	This is a code to represent the content of the generated alarm.
Alarm message	This is the content of the generated alarm.
Driver temperature	This is the driver temperature when an alarm was generated.
Inverter voltage	This is the internal voltage of the driver when an alarm was generated.
Selection Number	This is the operation data number selected when an alarm was generated.
Load factor	This is the load factor when an alarm was generated.
Command Speed	This is the command speed when an alarm was generated.
Feedback speed	This is the feedback speed when an alarm was generated.
Elapsed time from BOOT	This is the elapsed time until an alarm was generated from when the power was turned on.
Elapsed time from Motor move	This is the elapsed time until an alarm was generated from the start of operation.
Main power supply time	This is the cumulative elapsed time until an alarm was generated from when the main power supply was first time turned on.
Direct input*	This is the input status of the direct inputs (D-IN0 to D-IN4) when an alarm was generated. It is indicated in hexadecimal.
Remote input*	This is the input status of the remote inputs (R-IN0 to R-IN15) when an alarm was generated. It is indicated in hexadecimal.
Internal I/O*	This is the internal status of I/O signals when an alarm was generated. It is indicated in hexadecimal.
Sub code*	This is our code for checking.

* Details of each bit can be checked at the bottom of the alarm monitor window. (ON: green, OFF: white)

When the sensor error at power-on and the EEPROM error shortly after power-on are generated, "0" is shown in all fields. (Except for code, alarm message, main power supply time, internal I/O, and sub code)



Clearing the alarm history cannot be executed in a state where the HMI input is OFF (non-active state).

■ Information monitor

Information generation status and information history of the driver can be checked.



- Information history is saved in the RAM, so they are cleared when the power supply of the driver is turned off.
- Clearing the information history cannot be executed in a state where the HMI input is OFF (non-active state).

■ RS-485 communication monitor

Received data via RS-485 communication can be checked, and also communication error history can be monitored. The communication error history can be checked up to 10 items in order of the latest to oldest. All packets are monitored by the RS-485 communication monitor at the factory setting, but the target to be monitored can be restricted by changing the "RS-485 Receive packet monitor" parameter to "Only own address."

Item	Description
RS-485 Receive packet monitor	Monitors the target to perform the RS-485 communication monitor. The target to be monitored can be changed with the parameter setting.
Reception frame counter	Monitors the number of frames that the driver recognized to receive. The method to count the number of frames varies according to the target to be monitored. The target to be monitored can be changed with the parameter setting.
Communication packet	Monitors communication data. (Up to 64 bytes)
Reception byte	Monitors the number of bytes received via RS-485 communication.
Register write abnormal	Monitors the number of times that the received data was outside the setting range or the command was unable to execute.
Normal reception frame (All)	Monitors the number of normal frames that the driver recognized to receive.
Normal reception frame (Only own address)	Monitors the number of normal frames that the driver recognized to receive to own address.
Transmission byte	Monitors the number of bytes transmitted via RS-485 communication.
Abnormal reception frame (All)	Monitors the number of frames that the driver recognized to receive and judged to be abnormal.
Transmission frame	Monitors the number of frames that the driver transmitted.
COM Error Condition	Monitors the present communication error status.
Communication Error History	Monitors error codes and messages of communication errors occurred in the past, or causes and remedial actions of communication errors.

■ Waveform monitor

The motor rotation speed or the status of I/O signals can be checked in a waveform format.

Refer to the operating manual of the **MEXE02** for the procedures to operate the applicable products using the **MEXE02**.

● CH1 to CH4 (analog CH)

The rotation speed or the detected torque (actual torque), etc. can be checked. Using the waveform monitor can check successive changes.

Monitored items	Unit	Range selection
Command speed (motor shaft)	r/min	100, 200, 500, 1000, 2000, 5000
Actual speed (motor shaft)	r/min	100, 200, 500, 1000, 2000, 5000
Inverter voltage	V	1, 2, 5, 10, 20, 50
Actual torque	%	10, 20, 50, 100, 200
Selection number	–	1, 2, 5, 10

● CH5 to CH12 (digital CH)

The ON/OFF status of signals can be checked. There is no setting for range and offset in the digital CH.

Monitored items	Monitored items	Monitored items	Monitored items	Monitored items
ALM-A	INFO-CLR	INFO-TRQ-DE	R-IN10	R-OUT11
ALM-B	INFO-DRV	INFO-UVOLT	R-IN11	R-OUT12
ALM-RST	INFO-DRVTMP	M0	R-IN12	R-OUT13
D-IN0	INFO-DSLMTD	M1	R-IN13	R-OUT14
D-IN1	INFO-IOTEST	M2	R-IN14	R-OUT15
D-IN2	INFO-LOAD	MOVE	R-IN15	R0
D-IN3	INFO-NET-E	MPS	R-OUT0	R1
D-IN4	INFO-ODO	R-IN0	R-OUT1	R2
DIR	INFO-OVOLT	R-IN1	R-OUT2	R3
D-OUT0	INFO-REV	R-IN2	R-OUT3	REV (RUN/BRAKE)
D-OUT1	INFO-PCOUNT	R-IN3	R-OUT4	SPEED-OUT
EXT-ERROR	INFO-PTIME	R-IN4	R-OUT5	STOP-MODE (FWD/REV)
FWD (START/STOP)	INFO-RBT	R-IN5	R-OUT6	SYS-BSY
H-FREE	INFO-SET-E	R-IN6	R-OUT7	TL
HMI	INFO-SPD	R-IN7	R-OUT8	TLC
INFO	INFO-SPD-DE	R-IN8	R-OUT9	VA
INFO-CFG	INFO-TRIP	R-IN9	R-OUT10	

● Time scale

The following time scales can be set.

5, 10, 20, 50, 100, 200, 500, 1000, 2000, 5000 [Unit: ms]

13.3 Test operation

■ Teaching/remote operation

A motor can be operated using the **MEXE02**. The motor operation can be checked before connecting to a host controller.

Also, the teaching function of the operation data can be performed.

The PWR/ALM LED on the driver blinks in orange when teaching/remote operation is started.



- While teaching/remote operation is performed, the motor is operated based on the data set in the teaching data. If the motor is used in a state where the output torque is limited, check the setting of the teaching data before performing teaching/remote operation.
- If the communication is disconnected while the motor rotates, the motor stops instantaneously.
- If the operation input signal was ON (active state) when teaching/remote operation is completed, the operation prohibited information is generated. The operation prohibited information can be cleared by turning the operation input signal OFF.

■ I/O test

I/O signals of D-I/O or R-I/O can be tested.

Input signals can be monitored, and output signals can forcibly be turned ON or OFF to check the connection with a host controller.

The rotation speed or torque limiting value set by the external setting device etc. can be checked before operating the motor.

The PWR/ALM LED on the driver blinks in orange when I/O test is started.

Refer to the operating manual of the **MEXE02** for the operating method and others.



Output signals can forcibly be turned ON or OFF with I/O test. Therefore, other devices connected to the applicable product may operate. Before operation, check the condition of the surrounding area to ensure safety.

● Items possible to check on the I/O test monitor window

Monitored items	Description
Direct-I/O (D-I/O)	Monitors I/O signal names assigned to the direct I/O and the status of input/output to the direct I/O. The direct output can forcibly be turned ON or OFF.
Remote-I/O (R-I/O)	Monitors I/O signal names assigned to the remote I/O and the status of input/output to the remote I/O. The remote output can forcibly be turned ON or OFF.
External analog setting device *	Monitors the input voltage of the external analog setting device input to the driver. The values converted from the input voltage to the rotation speed and the torque limiting value are also monitored.
PWM signal input *	Monitors the duty cycle and the frequency of the PWM signal input to the driver. The values converted from the duty cycle and the frequency to the rotation speed and the torque limiting value are also monitored.

* "-" is displayed if not selected in the "External setting method" parameter.

Values before applying the limiter function such as the speed upper limit, speed lower limit, and torque limiting maximum value are shown for the converted values.



If the operation input signal was ON (active state) when I/O test is completed, the operation prohibited information is generated. The operation prohibited information can be cleared by turning the operation input signal OFF.

14 Maintenance and inspection

14.1 Inspection

It is recommended that periodic inspections are conducted for the items listed below after each operation of the motor. If an abnormal condition is noted, discontinue any use and contact your nearest Oriental Motor sales office.



- Do not conduct the insulation resistance measurement or the dielectric strength test with the motor and driver connected. Doing so may cause damage to the product.
- The driver uses semiconductor elements, so be extremely careful when handling them. Static electricity may damage the driver.

■ Inspection item

- Check if any of the mounting screws of the motor and gearhead is loose.
- Check if the bearing part (ball bearings) of the motor generates unusual noises.
- Check if the bearing part (ball bearings) or gear meshing part of the gearhead generates unusual noises.
- Check if the output shaft of the motor and gearhead and a load shaft are out of alignment.
- Check if a damage or stress is applied on the cable or the connection part between the cable and driver is loose.
- Check if dust is deposited on the driver.

14.2 Warranty

Check on the Oriental Motor Website for the product warranty.

14.3 Disposal

Dispose the product correctly in accordance with laws and regulations, or instructions of local governments.

15 Troubleshooting

The motor or driver may not operate properly if the rotation speed is wrongly set or the connection is wrong. If the motor cannot operate properly, refer to the contents provided in this chapter and take appropriate action. If the problem persists, contact your nearest Oriental Motor sales office.



Check the alarm contents when an alarm is generated. Check the motor movement using teaching/remote operation. If the motor rotates, there may be a mistake occurred either in the setting methods. I/O signal status and others can be checked using monitors of the **MEXE02** or RS-485 communication. Use when checking the wiring condition of the I/O signals and others.

<p>The motor does not operate.</p>	<ul style="list-style-type: none"> ● The power supply is not connected correctly or it is improper connection. ▷ Check the connection of the power supply. ● The operation input signal is not turned ON. ▷ Check the connection and the ON-OFF status of signal. The signal input status can be checked using the internal I/O monitor or D-I/O, R-I/O monitor. ● The operation data number is selected wrongly. Or the motor connector is not connected properly. ▷ Check the connection and the ON-OFF status of signal. The signal input status can be checked using the internal I/O monitor or D-I/O, R-I/O monitor. ● An alarm is present. ▷ Check if an alarm is generated. The PWR/ALM LED blinks in red while an alarm is present. The alarm content can be checked by counting the number of times the LED blinks or by using the MEXE02 or RS-485 communication. Refer to p.135, and reset the alarm after removing the cause of the alarm. ● The operation data is set wrongly. ▷ Check how to set the operation data. The setting method and the setting value of the operation data selected can be checked using the status monitor.
<p>The motor does not move according to the set operation data.</p>	<ul style="list-style-type: none"> ● The operation data number is selected wrongly. Or the motor connector is not connected properly. ▷ Check the connection and the ON-OFF status of signal. The signal input status can be checked using the internal I/O monitor or D-I/O, R-I/O monitor. ● The setting method or the setting value is wrong. ▷ Check the setting method. The setting method and the setting value presently set can be checked using the status monitor. ● A load is too large. ▷ Check if the torque is enough. ● An external analog setting device or PWM signal input is set wrongly. ▷ Check the setting value of the "External setting method" parameter. The setting of the "External setting method" parameter can be checked using the unit information monitor.
<p>The rotation speed cannot be increased.</p>	<ul style="list-style-type: none"> ● The rotation speed equal to or higher than the value set in the "Speed upper limit" parameter is set. ▷ Reconsider the setting value of the "Speed upper limit" parameter or operation data.
<p>The rotation speed cannot be decreased.</p>	<ul style="list-style-type: none"> ● The rotation speed lower than the value set in the "Speed lower limit" parameter is set. ▷ Reconsider the setting value of the "Speed lower limit" parameter or operation data.

<ul style="list-style-type: none"> • A time for stopping is long. • The stopping method is wrong. 	<ul style="list-style-type: none"> ● The stopping method is selected wrongly. <ul style="list-style-type: none"> ▷ Check the stopping method. In the case of the 3-wire mode of the operation input mode, the stop movement by turning the RUN/BRAKE input OFF is different from that by turning the START/STOP input OFF. In the case of the 2-wire mode of the operation input mode, the stop movement when the STOP-MODE input is ON is different from that when it is OFF. Refer to p.64 and p.65 for details. ▷ Check the deceleration stop with the value set in the "Deceleration mode selection" parameter. Check the setting value of the parameter using the unit information monitor. ● Load inertia is too large. <ul style="list-style-type: none"> ▷ Check by increasing the frictional load or reducing the load inertia.
<p>Torque limiting value is not increased.</p>	<ul style="list-style-type: none"> ● The value set in the "Torque limiting maximum value" parameter is exceeded. <ul style="list-style-type: none"> ▷ Reconsider the setting value of the "Torque limiting maximum value" parameter or operation data.
<p>Torque cannot be limited.</p>	<ul style="list-style-type: none"> ● If the TL input is turned OFF, the torque limiting function is disabled. <ul style="list-style-type: none"> ▷ Check the connection and the ON-OFF status of signal. The signal input status can be checked using the internal I/O monitor or D-I/O, R-I/O monitor.
<p>The PWR/ALM LED blinks in orange.</p>	<ul style="list-style-type: none"> ● Information is present. <ul style="list-style-type: none"> ▷ Information is present because of some kind of reason. Check the generated information using the information monitor or internal I/O monitor, and clear the cause of generation or disable the "INFO action" parameter.
<p>The motor rotates in the opposite direction to the specified one.</p>	<ul style="list-style-type: none"> ● The FWD/REV input is used wrongly or otherwise not connected correctly. <ul style="list-style-type: none"> ▷ Check the connection and the ON-OFF status of signal. The signal input status can be checked using the internal I/O monitor or D-I/O, R-I/O monitor. ● The "Motor rotation direction" parameter has been changed. <ul style="list-style-type: none"> ▷ The motor rotates in the forward direction when the FWD/REV input is turned ON. The setting for rotating in the forward direction can be set with the "Motor rotation direction" parameter. (Initial value: Positive (+) = CW) ● The gearhead with a reduction ratio which rotation direction is opposite to the motor output shaft is used. (Refer to p.27 for the rotation direction of the gearhead output shaft) <ul style="list-style-type: none"> ▷ Reverse the ON-OFF status of the FWD/REV input or invert the logic level setting of the input. Change the setting for the "Motor rotation direction" parameter. ● A hollow shaft flat gearhead is used. <ul style="list-style-type: none"> ▷ The hollow shaft flat gearhead rotates in the opposite direction to the motor when viewed from the front face of the gearhead, and rotates in the same direction to the motor when viewed from the rear face (motor mounting side).
<ul style="list-style-type: none"> • The motor movement is not stable. • Motor vibration is too large. 	<ul style="list-style-type: none"> ● The motor and gearhead output shaft and a load shaft are out of alignment. <ul style="list-style-type: none"> ▷ Check the coupling condition of the motor and gearhead output shaft and the load shaft. ● The motor output power and the driver output power are not matched. <ul style="list-style-type: none"> ▷ Check if the motor output power and the driver output power are the same. The driver output power can be checked by the driver model name in the unit information monitor. ● The product is affected by electrical noise. <ul style="list-style-type: none"> ▷ Check the operation only with the motor, the driver, and a minimum of external equipment required for operation. If an effect of noise has been confirmed, implement the following countermeasures: [Keep away from the noise sources.] [Reconsider the wiring.]

16 Alarms

This driver has the alarm function to protect from temperature rise, poor connection, error in operation, and others. If an alarm is generated, the ALM-A output is turned ON (in the case of normally open), or the ALM-B output is turned OFF (in the case of normally closed).

At the same time, the motor stops, and the PWR/ALM LED blinks in red.

The generated alarm content can be checked by counting the number of times the LED blinks or by using the **MEXE02** or RS-485 communication.

16.1 Alarm reset

Before resetting an alarm by one of the following methods, be sure to remove the cause of the alarm and ensure safety.

- Turn the ALM-RST input ON. (The alarm will be reset at the ON edge of the input.)
- Turn on the power again.
- Execute the alarm reset using the **MEXE02**.
- Execute the alarm reset by the maintenance command via RS-485 communication.



- Some alarms cannot be reset with other than turning on the power again. Refer to "16.4 Alarm list" on the next page.
- Continuing the operation without removing the cause of the alarm may cause damage to equipment.
- Perform the ALM-RST input after the motor (gearhead) output shaft is stopped completely.

Turn the operation input signal OFF, and remove the cause of the alarm before resetting the alarm.

The alarm reset is disabled while the operation input signal is being ON. Operation cannot be performed until the alarm is reset.

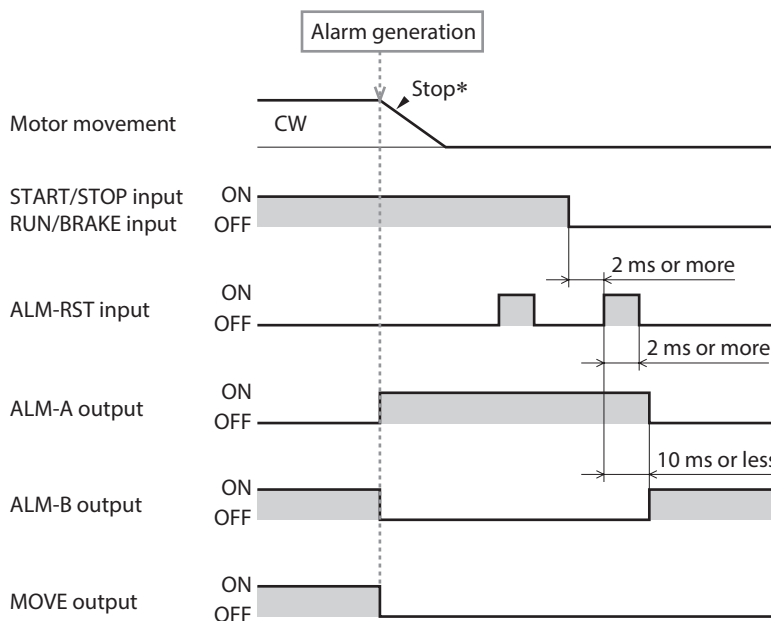

* If an alarm is generated while the motor rotates, the motor will coast to a stop.

If the RS-485 communication error or the RS-485 communication timeout alarm is generated, the motor will decelerate to stop. If the external stop alarm is generated, the motor will stop instantaneously.

The stopping method when an alarm is generated varies depending on the alarm type.

16.2 Alarm history

Up to 10 generated alarms are saved in the non-volatile memory in order of the latest to oldest.

Exceeding 10 alarm records will overwrite the data in order from the oldest recorded data.

Alarm history is not cleared even if the power is shut off.

Alarm history stored in the non-volatile memory can be read and cleared when any of the following items is performed.

- Read and clear the alarm history using the **MEXE02**.
- Read the alarm history with the monitor command of RS-485 communication.
- Clear the alarm history with the maintenance command of RS-485 communication.

The driver status when an alarm was generated is also stored in the alarm history. Items to be stored are shown in the table below.

Item	Description
Code (Hex)	This is a code to represent the content of the generated alarm.
Driver temperature	This is the driver temperature when an alarm was generated.
Inverter voltage	This is the internal voltage of the driver when an alarm was generated.
Selection Number	This is the operation data number selected when an alarm was generated.
Load factor	This is the load factor when an alarm was generated.
Command Speed	This is the command speed when an alarm was generated.
Feedback speed	This is the feedback speed when an alarm was generated.
Elapsed time from BOOT	This is the elapsed time until an alarm was generated from when the power was turned on.
Elapsed time from Motor move	This is the elapsed time until an alarm was generated from the start of operation.
Main power supply time	This is the cumulative elapsed time until an alarm was generated from when the main power supply was first time turned on.
Direct input*	This is the input status of the direct inputs (D-IN0 to D-IN4) when an alarm was generated. It is indicated in hexadecimal.
Remote input*	This is the input status of the remote inputs (R-IN0 to R-IN15) when an alarm was generated. It is indicated in hexadecimal.
Internal I/O*	This is the internal status of I/O signals when an alarm was generated. It is indicated in hexadecimal.
Sub code	This is our code for checking.

* Refer to the tables below for bit arrangements.

When the Initial sensor error and the EEPROM error shortly after power-on are generated, "0" is shown in all fields. (Except for code, alarm message, main power supply time, internal I/O, and sub code)



Clearing the alarm history cannot be executed in a state where the HMI input is OFF (non-active state).

● Direct input

bit 7	bit 6	bit 5	bit 4	bit 3	bit 2	bit 1	bit 0
-	-	-	D-IN4 [ALM-RST]	D-IN3 [M0]	D-IN2 [FWD/REV]	D-IN1 [RUN/BRAKE]	D-IN0 [START/STOP]

● Remote input

bit 15	bit 14	bit 13	bit 12	bit 11	bit 10	bit 9	bit 8
R-IN15 [Not used]	R-IN14 [Not used]	R-IN13 [Not used]	R-IN12 [Not used]	R-IN11 [Not used]	R-IN10 [Not used]	R-IN9 [Not used]	R-IN8 [Not used]
bit 7	bit 6	bit 5	bit 4	bit 3	bit 2	bit 1	bit 0
R-IN7 [ALM-RST]	R-IN6 [Not used]	R-IN5 [FWD/REV]	R-IN4 [RUN/BRAKE]	R-IN3 [START/STOP]	R-IN2 [M2]	R-IN1 [M1]	R-IN0 [M0]

Values in brackets [] are initial values.

● Internal I/O

bit 15	bit 14	bit 13	bit 12	bit 11	bit 10	bit 9	bit 8
-	-	-	TL	HMI	STOP-MODE (FWD/REV)	REV (RUN/BRAKE)	FWD (START/STOP)
bit 7	bit 6	bit 5	bit 4	bit 3	bit 2	bit 1	bit 0
-	-	SYS-BSY	VA	MOVE	DIR	TLC	SPEED-OUT

16.3 Generation condition of alarms

Alarms shown in the table will be generated if the generation condition is satisfied.

Alarm code	Alarm name	Generation condition
22h	Overvoltage	The driver internal voltage value exceeds 38 V.
25h	Undervoltage	The driver internal voltage value falls below 18 V.
31h	Overspeed	The feedback speed exceeds 5200 r/min.
21h	Main circuit overheat	The driver internal temperature exceeds 85°C (185°F).

16.4 Alarm list

Alarm code	Number of times PWR/ALM LED blinks	Alarm name	Cause	Remedial action	Alarm reset
20h	7	Overcurrent	<ul style="list-style-type: none"> Excessive current was flow through the driver due to ground fault, etc. The motor, the cable, and the driver output circuit were short-circuited. The driver was malfunctioned due to noise. 	<ul style="list-style-type: none"> Turn off the power, and turn on the power again after checking if the product is not damaged. If the alarm is still generated, the motor, the cable, or the driver may be damaged. Contact your nearest Oriental Motor sales office. Reconsider wirings and the like, and take measures to eliminate noise. 	Not possible
21h	9	Main circuit overheat	The internal temperature of the driver exceeded 85°C (185°F).	<ul style="list-style-type: none"> Reconsider the ambient temperature. Reconsider the ventilation condition. Reconsider the operating condition. 	Possible
22h	4	Overvoltage	<ul style="list-style-type: none"> The internal voltage of the driver exceeded 38 VDC. A large load inertia was stopped abruptly. 	<ul style="list-style-type: none"> Check the input voltage of the power supply. If the alarm is generated during operation, decrease a load or increase the deceleration time. If the motor is rotated by external force, reconsider how to use or environment. 	Possible
25h	5	Undervoltage	The internal voltage of the driver fell below 18 VDC.	<ul style="list-style-type: none"> Check the input voltage of the power supply. Check the connection between the driver and the power supply. 	Possible
28h	3	Sensor error	<ul style="list-style-type: none"> The sensor line in the motor cable was disconnected. Or the motor cable was come off. The driver failed to recognize the hall signals due to noise. The sensor of the motor is not operated properly. 	<ul style="list-style-type: none"> Check the connection between the driver and the motor. Reconsider wirings and the like, and take measures to eliminate noise. The motor may be damaged. Contact your nearest Oriental Motor sales office. 	Possible
30h	2	Overload	<ul style="list-style-type: none"> A load exceeding the rated torque was applied to the motor for 10 seconds or more. *1 An operation was performed in a state of connecting a motor and a driver which combination was not allowed. An operation was performed in a state where the motor power line was disconnected. 	<ul style="list-style-type: none"> Decrease a load. Reconsider operating conditions such as the acceleration time and deceleration time. If the alarm is generated at a low temperature, warm up. Check if the motor and driver combination is correct. Check if the motor power line is disconnected. 	Possible
31h	6	Overspeed	The motor feedback speed was exceeded 5200 r/min.	<ul style="list-style-type: none"> Decrease a load. Reconsider operating conditions such as the acceleration time and deceleration time. If the motor is rotated by external force, reconsider how to use or environment. 	Possible

*1 The time until the overload alarm is generated can be changed using the "Overload alarm detection time" parameter.

Alarm code	Number of times PWR/ALM LED blinks	Alarm name	Cause	Remedial action	Alarm reset
41h	8	EEPROM error	The data stored in the driver was damaged.	Execute either of the following operations, and turn on the power again. <ul style="list-style-type: none"> Execute "Restored to the factory setting" with the MEXE02. Execute initialization via RS-485 communication. If the alarm is still generated, the driver may be damaged. Contact your nearest Oriental Motor sales office.	Not possible
42h	3	Sensor error at power-on	<ul style="list-style-type: none"> The sensor line in the motor cable was disconnected. Or the power supply of the driver was turned on in a state where the motor cable was come off. The power supply was turned on in a state where the sensor of the motor is not operated properly. 	<ul style="list-style-type: none"> Check the connection between the driver and the motor. The motor may be damaged. Contact your nearest Oriental Motor sales office. 	Possible
46h	11	Prevention of operation at power-on	The power supply of the driver was turned on in the following conditions. <ul style="list-style-type: none"> The "Prevention of operation at power-on alarm" parameter was set to "Enable." The operation input signal is in an ON state.*2 	Turn off the operation input signal before turning on the power supply.	Possible
6Eh	10	External stop	<ul style="list-style-type: none"> The EXT-ERROR input signal was turned OFF.*3 "External stop" was executed using the MEXE02. "External stop" was executed via RS-485 communication. 	Check the status of the EXT-ERROR input signal.	Possible
84h	12	RS-485 communication error	The number of consecutive generated RS-485 communication errors reached the value set in the "RS-485 communication error alarm" parameter.	<ul style="list-style-type: none"> Check the connection between the driver and the host controller . Check the setting of RS-485 communication. 	Possible
85h	12	RS-485 communication timeout	The time set in the "RS-485 communication timeout alarm" parameter has elapsed, and yet the communication could not be established with the host controller.	Check the connection between the driver and the host controller .	Possible
F0h	Lit	CPU error	The CPU is not operated properly.	Turn on the power again. If the alarm is still generated, the driver may be damaged. Contact your nearest Oriental Motor sales office.	Not possible

*2 When the operation input mode is 3-wire mode: Both the START/STOP input and the RUN/BRAKE input are in an ON state
When the operation input mode is 2-wire mode: Either of the FWD input or the REV input is in an ON state

*3 It is always ON in a state where the EXT-ERROR input is not assigned.

17 Information

The driver is equipped with a function to generate information output before an alarm is generated. This function can be utilized for periodic maintenance of equipment by setting a suitable value in the parameter of each information.

■ Status when information is generated

● Information bit output

If information is generated, a bit output (INFO-** output) of the corresponding information is turned ON. Each bit output of information can be assigned to direct output or remote output. Also, the output state can be checked with the internal I/O monitor and waveform monitor of the **MEXE02**, or the maintenance command via RS-485 communication.

● INFO output

If any of information is generated, the INFO output will be turned ON.

● LED indicator

If information is generated, the PWR/ALM LED will blink twice in orange.

● Motor operation

The motor continues to operate during information unlike in the case of an alarm.

■ Related parameters

A generation condition for some information can be adjusted by parameter setting. Each information has a corresponding "INFO action" parameter. If the parameter is set to "INFO action is not applied," only the bit output of information is turned ON, and the INFO output and LED are not changed. Also, by setting the "INFO auto clear" parameter, you can select whether the INFO output or the bit output of the corresponding information is automatically turned OFF when the cause of information is cleared.

■ Clear information

At the factory setting, the generated information will automatically be cleared if the release condition is satisfied ("Information auto clear" parameter: "Enable").

If the generated state is required to keep, set the "Information auto clear" parameter to "Disable." Setting to "Disable" will continue the generated state of the information even if the release condition is satisfied.

17.1 Information history

Up to 16 generated information are saved in the RAM in order of the latest to oldest.

Information items stored as the information history are the information code, generation time, and contents of information.

The information history stored can be read and cleared when one of the following items is performed.

- Read and clear the information history using the information monitor of the **MEXE02**.
- Read the information history by the monitor command via RS-485 communication.
- Clear the information history by the maintenance command via RS-485 communication.

Note

- Information history will be cleared if the power supply of the driver is turned OFF because it is saved in the RAM.
- Clearing the information history cannot be executed in a state where the HMI input is OFF (non-active state).

17.2 Information lists

bit	Information	Information bit output signal	Cause	Condition to reset and clear
2	Driver temperature	INFO-DRVTMP	The internal temperature of the driver increased to the value set in the "Driver temperature information" parameter or higher.	The internal temperature of the driver fell below the value set in the "Driver temperature information" parameter by 5°C.
4	Overvoltage	INFO-OVOLT	The internal voltage of the driver increased to the value set in the "Overvoltage information" parameter or higher.	The internal voltage of the driver fell below the value set in the "Overvoltage information" parameter by 0.5 V.
5	Undervoltage	INFO-UVOLT	The internal voltage of the driver dropped to the value set in the "Undervoltage information" parameter or lower.	The internal voltage of the driver exceeded the value set in the "Undervoltage information" parameter by 0.5 V.
7	Load	INFO-LOAD	The detected torque of the motor increased to the value set in the "Load information" parameter or larger.	The detected torque of the motor fell below the value set in the "Load information" parameter.
8	Speed	INFO-SPD	The detected speed of the motor increased to the value set in the "Speed information" parameter or higher.	The detected speed of the motor fell below the value set in the "Speed information" parameter by 5 r/min.
9	Operation data setting error	INFO-SET-E	There is an error in the combination of parameters set in the operation data. Setting method ⇒ p.22	The data was set again so that the combination of parameters set in the operation data was correct.
12	Operation prohibited	INFO-DRV	Any of the following operations was performed and caused a state of operation prohibition. *1 <ul style="list-style-type: none"> • The operation input signal is being ON when "I/O test" or "teaching/remote operation" of the MEXE02 was completed. *2 • Configuration was executed in a state where the motor would immediately rotate by changing the assignment or the logic level setting of input terminals. • An operation of the operation data number, which setting method of operation data was a state of abnormal combination, was executed. 	Any of the following operations was performed, and the state of operation prohibition was released. <ul style="list-style-type: none"> • The operation input signal was turned OFF. *2 • The operation data setting method was set again. • The operation data number was changed to an operation data number that the setting is correct.
15	RS-485 communication error	INFO-NET-E	The number of consecutive RS-485 communication errors reached the value set in the "RS-485 communication error information" parameter.	RS-485 communication was performed properly.
19	Rotation amount meter*3	INFO-REV	The rotation amount inside the driver was out of the range of the "Rotation amount meter information" parameter.	Any of the following operations was performed, and the rotation amount was brought within the setting range of the "Rotation amount meter information" parameter. <ul style="list-style-type: none"> • The "Rotation amount meter information" parameter was set again. • "Clear rotation amount meter" was executed with the MEXE02. • "Clear rotation amount meter" was executed via RS-485 communication.

*1 The motor does not move if the driver is in a state of operation prohibition.

*2 A condition to turn the operation input signal ON varies depending on the setting of the "Operation input mode selection" parameter.

*3 The rotation amount is reset when the power supply is turned off because it is saved in the RAM. It can also be reset with the **MEXE02** or the maintenance command via RS-485 communication.

If a value in the "Rotation amount meter information" parameter is set so that the negative side is larger than the positive side or the positive side is smaller than the negative side, the information will be a state of always being generated.

bit	Information	Information bit output signal	Cause	Condition to reset and clear
20	Tripmeter*4	INFO-TRIP	The cumulative rotation amount inside the driver (tripmeter) increased to the value set in the "Tripmeter information" parameter or more.	One of the following operations was performed, and cumulative rotation amount inside the driver (tripmeter) fell below the value set in the "Tripmeter information" parameter. <ul style="list-style-type: none"> • The "Tripmeter information" parameter was set again. • "Clear tripmeter" was executed with the MEXE02. • "Clear tripmeter" was executed via RS-485 communication.
21	Odometer*5	INFO-ODO	The cumulative rotation amount inside the driver (odometer) increased to the value set in the "Odometer information" parameter or more.	The "Odometer information" parameter was set again, and the cumulative rotation amount inside the driver (odometer) fell below the value set in the "Odometer information" parameter.
24	Torque limiting value setting error	INFO-TRQ-DE	The data exceeding the torque limiting value set in the "Torque limiting maximum value" parameter is set.	<ul style="list-style-type: none"> • The torque limiting value having set was set again so that it was lower than the value set in the "Torque limiting maximum value" parameter. • The value set in the "Torque limiting maximum value" parameter was set again so that it was larger than the torque limiting value having set.
25	Rotation speed setting error	INFO-SPD-DE	Data larger than the rotation speed in the "Speed upper limit" parameter or smaller than that in the "Speed lower limit" parameter is set.	<ul style="list-style-type: none"> • The rotation speed below the value set in the "Speed upper limit" parameter was set again. Or the rotation speed exceeding the value set in the "Speed lower limit" parameter was set again. • The value exceeding the motor rotation speed was set in the "Speed upper limit" parameter again. Or the value below the motor rotation speed was set in the "Speed lower limit" parameter again.
26	Main power supply time	INFO-PTIME	A time period having supplied the power to the main power supply of the driver increased to the value set in the "Main power supply time information" parameter or more.	The "Main power supply time information" parameter was set again, and the time period having supplied the power to the main power supply of the driver fell below the value set in the "Main power supply time information" parameter.
27	Main power count	INFO-PCOUNT	The number of times to turn on the main power supply of the driver increased to the value set in the "Main power supply count information" parameter or more.	The "Main power supply count information" parameter was set again, and the number of times to turn on the main power supply of the driver fell below the value set in the "Main power supply count information" parameter.
28	Operation start limit mode	INFO-DSLMTD	<ul style="list-style-type: none"> • "Teaching/remote operation" was executed. • "Configuration" was executed. • "Data writing" was executed with the MEXE02. • "Restored to the factory setting" was executed. 	<ul style="list-style-type: none"> • "Teaching/remote operation" was complete. • "Configuration" was complete. • "Data writing" with the MEXE02 was complete. • "Restored to the factory setting" was complete.
29	I/O test mode	INFO-IOTEST	<ul style="list-style-type: none"> • "I/O test" was executed. • "Configuration" was executed. 	<ul style="list-style-type: none"> • "I/O test" was complete. • "Configuration" was complete.
30	Configuration request	INFO-CFG	A parameter that required "Configuration" was changed. (Update timing: C)	"Configuration" was executed.
31	Power cycling request	INFO-RBT	A parameter that required to turn on the driver power again was changed. (Update timing: D)	The driver power was turned on again.

*4 The tripmeter is saved in the non-volatile memory in the driver at intervals of one minute. If the power supply is turned off before saving in the driver, the rotation amount for one minute is not applied.

*5 The odometer is saved in the non-volatile memory in the driver at intervals of one minute. If the power supply is turned off before saving in the driver, the rotation amount for one minute is not applied.

17.3 Information codes

The information codes represents the generation status of information in a 8-digit hexadecimal number (it is possible to read in 32-bit via RS-485 communication). If multiple information items are generated, they are represented in the OR value of the information code.

Example) When information items of the overvoltage and the driver temperature are generated

Information code of overvoltage: 0000 0010h

Information code of driver temperature: 0000 0004h

OR value of two information codes: 0000 0014h

Information code	Display in 32 bits								Information item
	bit 31 to bit 28	bit 27 to bit 24	bit 23 to bit 20	bit 19 to bit 16	bit 15 to bit 12	bit 11 to bit 8	bit 7 to bit 4	bit 3 to bit 1	
00000004h	0000	0000	0000	0000	0000	0000	0000	0100	Driver temperature
00000010h	0000	0000	0000	0000	0000	0000	0001	0000	Overvoltage
00000020h	0000	0000	0000	0000	0000	0000	0010	0000	Undervoltage
00000080h	0000	0000	0000	0000	0000	0000	1000	0000	Load
00000100h	0000	0000	0000	0000	0000	0001	0000	0000	Speed
00000200h	0000	0000	0000	0000	0000	0010	0000	0000	Operation data setting error
00001000h	0000	0000	0000	0000	0001	0000	0000	0000	Operation prohibited
00008000h	0000	0000	0000	0000	1000	0000	0000	0000	RS-485 communication error
00080000h	0000	0000	0000	1000	0000	0000	0000	0000	Rotation amount meter
00100000h	0000	0000	0001	0000	0000	0000	0000	0000	Tripmeter
00200000h	0000	0000	0010	0000	0000	0000	0000	0000	Odometer
01000000h	0000	0001	0000	0000	0000	0000	0000	0000	Torque limiting value setting error
02000000h	0000	0010	0000	0000	0000	0000	0000	0000	Rotation speed setting error
04000000h	0000	0100	0000	0000	0000	0000	0000	0000	Main power supply time
08000000h	0000	1000	0000	0000	0000	0000	0000	0000	Main power supply count
10000000h	0001	0000	0000	0000	0000	0000	0000	0000	Operation start limit mode
20000000h	0010	0000	0000	0000	0000	0000	0000	0000	I/O test mode
40000000h	0100	0000	0000	0000	0000	0000	0000	0000	Configuration request
80000000h	1000	0000	0000	0000	0000	0000	0000	0000	Power cycling request

18 Specifications

18.1 Specifications

Values in the rated torque, peak torque, rated rotation speed, and speed control range represent those in a state where the gearhead is not combined. For details about the motor, refer to the operating manual of the motor. Check on the Oriental Motor Website for the product specifications.

■ Applicable motor: BLHM motor

Model	Driver	BLH2D15-KR	BLH2D30-KR	BLH2D50-KR
	Motor	BLHM015	BLHM230	BLHM450
Rated output power (Continuous)		15 W	30 W	50 W
Power supply input	Rated voltage	24 VDC		
	Permissible voltage range	-10 to +10%		
	Rated input current	0.93 A	1.9 A	2.9 A
	Maximum input current*1	2.3 A (2.4 A)	4.1 A (4.2 A)	5.4 A (6.1 A)
Rated torque		0.048 N·m (6.8 oz-in)	0.115 N·m (16.3 oz-in)	0.191 N·m (27 oz-in)
Peak torque		0.072 N·m (10.2 oz-in)	0.173 N·m (24 oz-in)	0.287 N·m (40 oz-in)
Rated rotation speed		3000 r/min	2500 r/min	
Speed control range		80 (100 *2) to 3000 r/min		

*1 () in parentheses are for 3 m (9.8 ft.) and 5 m (16.4 ft.) between motor and driver

*2 Analog setting

■ Applicable motor: BLM motor

Model	Driver	BLH2D15H-KR	BLH2D30DH-KR	BLH2D30H-KR
	Motor	BLM015HK	BLM030DHK	BLM230HK
Rated output power (Continuous)		15 W	30 W	
Power supply input	Rated voltage	24 VDC		
	Permissible voltage range	-10 to +10%		
	Rated input current	0.96 A	1.8 A	
	Maximum input current*1	2.5 A (2.7 A)	4.4 A (4.5 A)	3.9 A (3.9 A)
Rated torque		0.048 N·m (6.8 oz-in)	0.096 N·m (13.6 oz-in)	0.115 N·m (16.3 oz-in)
Peak torque		0.072 N·m (10.2 oz-in)	0.144 N·m (20 oz-in)	0.173 N·m (24 oz-in)
Rated rotation speed		3000 r/min		2500 r/min
Speed control range		80 (100 *2) to 3000 r/min		

Model	Driver	BLH2D50DH-KR	BLH2D50H-KR
	Motor	BLM250DHK	BLM450HK
Rated output power (Continuous)		50 W	
Power supply input	Rated voltage	24 VDC	
	Permissible voltage range	-10 to +10%	
	Rated input current	2.9 A	
	Maximum input current*1	5.8 A (7.0 A)	5.9 A (6.9 A)
Rated torque		0.191 N·m (27 oz-in)	
Peak torque		0.287 N·m (40 oz-in)	
Rated rotation speed		2500 r/min	
Speed control range		80 (100 *2) to 3000 r/min	

*1 () in parentheses are for 3 m (9.8 ft.) and 5 m (16.4 ft.) between motor and driver

*2 Analog setting

18.2 General specifications

Operating environment	Ambient temperature	Driver: 0 to +50 °C [+32 to +122 °F] (non-freezing)
	Ambient humidity	85% or less (non-condensing)
	Altitude	Up to 1000 m (3300 ft.) above sea level
	Surrounding atmosphere	No corrosive gas, dust. Cannot be used in radioactive materials, magnetic field, vacuum or other special environment. (Details about the installation location are described on p.10.)
	Vibration	Not subject to continuous vibrations or excessive impact. In conformance with JIS C 60068-2-6 "Sine-wave vibration test method" Frequency range: 10 to 55 Hz Pulsating amplitude: 0.15 mm (0.006 in.) Sweep direction: 3 directions (X, Y, Z) Number of sweeps: 20 times
Storage environment Shipping environment	Ambient temperature	Driver: -25 to +70 °C [-13 to +158 °F] (non-freezing)
	Ambient humidity	85% or less (non-condensing)
	Altitude	Up to 3000 m (10000 ft.) above sea level
	Surrounding atmosphere	No corrosive gas, dust, water or oil. Cannot be used in radioactive materials, magnetic field, vacuum or other special environment.
Degree of protection		IP00

18.3 Dimensions

Mass: 46 g (1.62 oz.)

[Unit: mm (in.)]

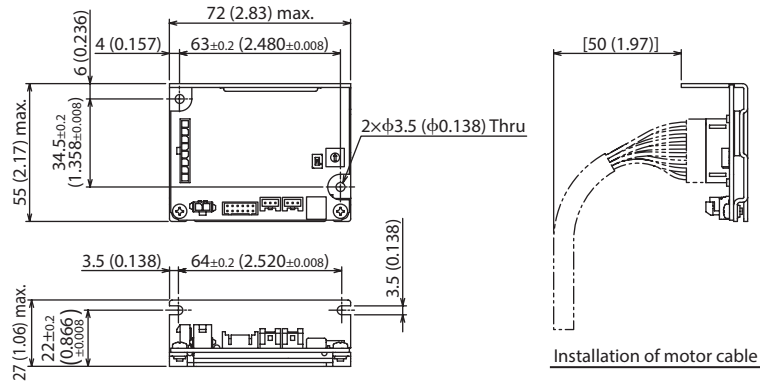

19 Regulations and standards

19.1 UL Standards, CSA Standards

This product is recognized by UL under the UL and CSA Standards.

19.2 CE Marking/UKCA Marking

This product is affixed with the marks under the following directives/regulations.

EU EMC Directive/UK EMC Regulation

Refer to "6.11 Conformity to EMC" on p.20 for details about conformity.

19.3 EU RoHS Directive/UK RoHS Regulation

This product does not contain the substances exceeding the restriction values.

19.4 Republic of Korea, Radio Waves Act

KC Mark is affixed to this product under the Radio Waves Act, the republic of Korea.

- Unauthorized reproduction or copying of all or part of this manual is prohibited.
If a new copy is required to replace an original manual that has been damaged or lost, please contact your nearest Oriental Motor branch or sales office.
- Oriental Motor shall not be liable whatsoever for any problems relating to industrial property rights arising from use of any information, circuit, equipment or device provided or referenced in this manual.
- Characteristics, specifications and dimensions are subject to change without notice.
- While we make every effort to offer accurate information in the manual, we welcome your input. Should you find unclear descriptions, errors or omissions, please contact the nearest office.
- **Oriental motor** is a registered trademark or trademark of Oriental Motor Co., Ltd., in Japan and other countries.
Modbus is a registered trademark of Schneider Automation Inc.
Other product names and company names mentioned in this manual may be registered trademarks or trademarks of their respective companies and are hereby acknowledged. The third-party products mentioned in this manual are recommended products, and references to their names shall not be construed as any form of performance guarantee. Oriental Motor is not liable whatsoever for the performance of these third-party products.

© Copyright ORIENTAL MOTOR CO., LTD. 2019

Published in July 2023

- Please contact your nearest Oriental Motor office for further information.

ORIENTAL MOTOR U.S.A. CORP.
Technical Support Tel:800-468-3982
8:30am EST to 5:00pm PST (M-F)
www.orientalmotor.com

ORIENTAL MOTOR (EUROPA) GmbH
Schiessstraße 44, 40549 Düsseldorf, Germany
Technical Support Tel:00 800/22 55 66 22
www.orientalmotor.de

ORIENTAL MOTOR (UK) LTD.
Unit 5 Faraday Office Park, Rankine Road,
Basingstoke, Hampshire RG24 8QB UK
Tel:+44-1256347090
www.oriental-motor.co.uk

ORIENTAL MOTOR (FRANCE) SARL
Tel:+33-1 47 86 97 50
www.orientalmotor.fr

ORIENTAL MOTOR ITALIA s.r.l.
Tel:+39-02-93906347
www.orientalmotor.it

ORIENTAL MOTOR ASIA PACIFIC PTE. LTD.
Singapore
Tel:1800-842-0280
www.orientalmotor.com.sg

ORIENTAL MOTOR (MALAYSIA) SDN. BHD.
Tel:1800-806-161
www.orientalmotor.com.my

ORIENTAL MOTOR (THAILAND) CO., LTD.
Tel:1800-888-881
www.orientalmotor.co.th

ORIENTAL MOTOR (INDIA) PVT. LTD.
Tel:1800-120-1995 (For English)
1800-121-4149 (For Hindi)
www.orientalmotor.co.in

TAIWAN ORIENTAL MOTOR CO., LTD.
Tel:0800-060708
www.orientalmotor.com.tw

SHANGHAI ORIENTAL MOTOR CO., LTD.
Tel:400-820-6516
www.orientalmotor.com.cn

INA ORIENTAL MOTOR CO., LTD.
Korea
Tel:080-777-2042
www.inaom.co.kr

ORIENTAL MOTOR CO., LTD.
4-8-1 Higashiueno, Taito-ku, Tokyo
110-8536 Japan
Tel:+81-3-6744-0361
www.orientalmotor.co.jp