

OPERATING MANUAL

Brushless Motor BLHM Motor



Introduction

■ Before using the product

Only qualified personnel of electrical and mechanical engineering should work with the product.

Use the product correctly after thoroughly reading the section "Safety precautions." In addition, be sure to observe the contents described in warning, caution, and note in this manual. The product described in this document has been designed and manufactured to be incorporated in general industrial equipment. Do not use for any other purpose. For the power supply, use a DC power supply with reinforced insulation on its primary and secondary sides. Oriental Motor Co., Ltd. is not responsible for any damage caused through failure to observe this warning.

■ Related operating manuals

Operating manuals for this product are listed below. Operating manuals are not included with the product. Download from Oriental Motor Website Download Page or contact your nearest Oriental Motor sales office.

	Operating manual name	
Motor	BLHM Motor OPERATING MANUAL (this document)	
Driver	BLH Series	Analog Setting Type OPERATING MANUAL
		Analog Setting Type 100 W OPERATING MANUAL
		Digital Setting Type OPERATING MANUAL
		RS-485 Communication Type OPERATING MANUAL

Refer to the operating manuals of the driver for details about connections and operations.

Safety precautions

The precautions described below are intended to ensure the safe and correct use of the product, and to prevent the customer and others from exposure to the risk of injury. Use the product only after carefully reading and fully understanding these instructions.

WARNING	Handling the product without observing the instructions that accompany a "WARNING" symbol may result in serious injury or death.
CAUTION	Handling the product without observing the instructions that accompany a "CAUTION" symbol may result in injury or property damage.
Note	The items under this heading contain important handling instructions that the user should observe to ensure safe use of the product.

[Description of graphic symbols]

: Indicates "prohibited" actions that must not be performed.

: Indicates "compulsory" actions that must be performed.

WARNING

- Do not use the product in explosive or corrosive environments, in the presence of flammable gases, or near combustibles. Doing so may result in fire or injury.
- Do not move, install, connect or inspect the product while the power is supplied. Always turn off the power before carrying out these operations. Damage to equipment may result.
- Do not use a motor in a vertical application. If the driver protective function is activated, the motor will stop and the moving part may drop, thereby causing injury or damage to equipment.
- Do not machine or modify the motor cable or connection cable. Doing so may result in fire or damage to equipment.
- Do not forcibly bend, pull or pinch the cable. Doing so may result in fire or damage to equipment.
- Do not touch the motor and driver when conducting the insulation resistance measurement or dielectric strength test. Accidental contact may result in electric shock.

Thank you for purchasing an Oriental Motor product.

This Operating Manual describes product handling procedures and safety precautions.

- Please read it thoroughly to ensure safe operation.
- Always keep the manual where it is readily available.

WARNING

- Do not disassemble or modify the motor and gearhead. Doing so may result in injury or damage to equipment. Refer all such internal inspections and repairs to the branch or sales office from which you purchased the product.
- Only qualified and educated personnel should be allowed to perform installation, connection, operation and inspection/troubleshooting of the product. Handling by unqualified and uneducated personnel may result in fire, injury or damage to equipment.
- Use a motor, gearhead, and driver only in the specified combination. An incorrect combination may cause fire or damage to equipment.
- Install the motor, gearhead and driver in an enclosure. Failure to do so may result in injury.

CAUTION

- Do not use the motor and gearhead beyond the specifications. Doing so may result in fire, injury or damage to equipment.
- Do not touch the motor and gearhead while operating or immediately after stopping. The surfaces of the motor and gearhead are hot, and it may cause a skin burn(s).
- Do not leave anything around the motor that would obstruct ventilation. Doing so may result in damage to equipment.
- Do not lift up the product by holding the output shaft or the motor cable. Doing so may result in injury.
- Do not touch the motor output shaft (end or pinion) with bare hands. Doing so may cause injury.
- When assembling the motor (pinion shaft) with the gearhead, exercise caution not to pinch your fingers or other parts of your body between the motor and gearhead. Injury may result.
- When installing the motor or gearhead in the equipment, exercise caution not to pinch your fingers or other parts of your body between the equipment and motor or gearhead. Injury may result.
- Do not touch the rotating part (output shaft) while operating the motor. Doing so may cause injury.
- Securely install the motor and gearhead to the mounting plate. Inappropriate installation may cause the motor and gearhead to detach and fall, resulting in injury or damage to equipment.
- Provide a cover over the rotating part (output shaft) of the motor or gearhead. Failure to do so may result in injury.
- Securely install a load on the output shaft of the motor or gearhead. Inappropriate installation may result in injury.
- Be sure to ground the motor and driver to prevent them from being damaged by static electricity. Failure to do so may result in fire or damage to equipment.
- The motor surface temperature may exceed 70°C (158°F) even under normal operating conditions. If the operator is allowed to approach the motor in operation, attach a warning label in a conspicuous position as shown in the figure. Failure to do so may result in a skin burn(s).



Warning label

Precautions for use

This section explains restrictions and requirements the user should consider when using the product.

- Be sure to match the motor output power with the driver output power.**

- Connecting the motor and driver**

Use a connection cable (sold separately) when extending the wiring distance between the motor and the driver. The maximum extension distance including the length of the motor cable should be 5 m (16.4 ft.).

- Do not perform gravitational operation (vertical drive).**

If this product is performed operation (i.e. gravitational operation) in which the motor output shaft is turned from the load side, the motor speed cannot be controlled. In addition, gravitational operation will cause the internal voltage of the driver to exceed the permissible value, thereby triggering the protective function and causing the motor to coast to a stop. If this happens, there is a possibility that the load will drop.

● Grease measures

On rare occasions, grease may ooze out from the gearhead. If there is concern over possible environmental contamination resulting from the leakage of grease, check for grease stains during regular inspections. Alternatively, install an oil pan or other device to prevent damage resulting from contamination.

Grease leakage may lead to problems in the user's equipment or products.

● Apply grease to the hollow output shaft of a hollow shaft flat gearhead.

Apply grease (molybdenum disulfide grease, etc.) on the surface of the load shaft and inner walls of the hollow output shaft to prevent seizure.

● Note when using in low temperature environment

When an ambient temperature is low, since the load torque may increase by the oil seal or viscosity increment of grease used in the gearhead, the output torque may decrease or the overload alarm may generate. However, as time passes, the oil seal or grease is warmed up, and the motor can be operated without generating the overload alarm.

● Rotation direction of the gearhead output shaft

● Geared type, combination type-parallel shaft gearhead

The rotation direction of the gearhead output shaft may vary with that of the motor output shaft depending on the gear ratio of the gearhead.

Geared type (15 W)

Gear ratio	Rotation direction of the gearhead output shaft
5, 10, 15, 50, 100	Same direction as the motor output shaft
20, 30	Opposite direction to the motor output shaft

Combination type-parallel shaft gearhead

Gear ratio	Rotation direction of the gearhead output shaft
5, 10, 15, 20, 200	Same direction as the motor output shaft
30, 50, 100	Opposite direction to the motor output shaft

● Combination type-hollow shaft flat gearhead

The rotation directions of the gearhead output shaft relative to the motor output shaft are as shown in the figures below.

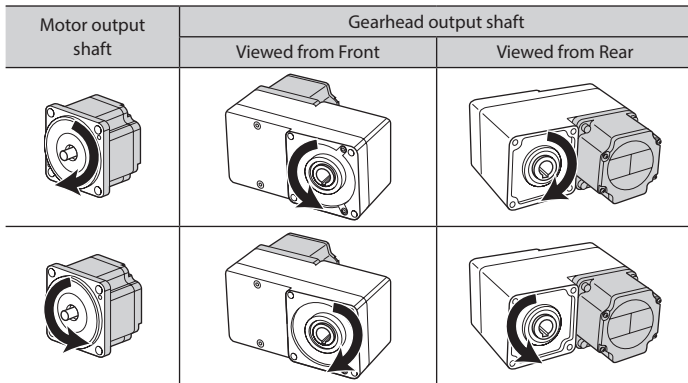

Check the operating manual of the driver for the rotation direction of the gearhead output shaft relative to the operation input signals of the driver.

Checking the product

This section explains the items you should check, as well as the name of each part.

■ Package contents

Verify that the items listed below are included.

Report any missing or damaged items to the branch or sales office from which you purchased the product.

● Geared type, Round shaft type

- Motor 1 unit (a geared type is motor with gearhead)
- Instructions and Precautions for Safe Use 1 copy

● Combination type-parallel shaft gearhead

- Motor 1 unit (a gearhead is pre-assembled)
- Mounting screw 1 set
(hexagonal socket head screw, plain washer, spring washer, nut each 4 pieces, parallel key 1 piece)
- Instructions and Precautions for Safe Use 1 copy

● Combination type-hollow shaft flat gearhead

- Motor 1 unit (a gearhead is pre-assembled)
- Mounting screw 1 set
(hexagonal socket head screw, plain washer, spring washer, nut each 4 pieces, parallel key 1 piece)
- Safety cover 1 set
(safety cover 1 piece, mounting screw for safety cover 2 pieces.)
- Instructions and Precautions for Safe Use 1 copy

■ Model

Verify the model name of the purchased product against the model shown on the package label. Check the motor model and the gearhead model against the model name shown on their nameplates, respectively.

Tell us the model name, product serial number, and manufacturing date when you contact us.

- The box (□) in the model name indicates a number representing the gear ratio.
- For the lead wire type, "KC" of the model is replaced by "K" (except for 15 W type).

Cable type: **BLHM**__**KC**-□, **BLHM**__**KC**-GFS
Lead wire type: **BLHM**__**K**-□, **BLHM**__**K**-GFS

● Geared type

Output power	Model
15 W	BLHM015K -□

For the geared type, the gearhead cannot be removed from the motor.

● Combination type-parallel shaft gearhead

Output power	Model	Motor model	Gearhead model
30 W	BLHM230KC -□	BLHM230KC-GFS	GFS2G□
50 W	BLHM450KC -□	BLHM450KC-GFS	GFS4G□
100 W	BLHM5100KC -□	BLHM5100KC-GFS	GFS5G□

● Combination type-hollow shaft flat gearhead

Output power	Model	Motor model	Gearhead model
30 W	BLHM230KC -□FR	BLHM230KC-GFS	GFS2G□FR
50 W	BLHM450KC -□FR	BLHM450KC-GFS	GFS4G□FR
100 W	BLHM5100KC -□FR	BLHM5100KC-GFS	GFS5G□FR

● Round shaft type

Output power	Model
15 W	BLHM015K -A
30 W	BLHM230K -A
50 W	BLHM450K -A
100 W	BLHM5100K -A

■ Information about nameplate

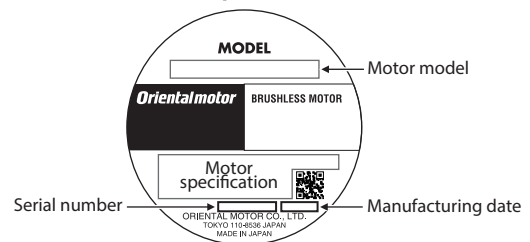

■ Drivers possible to combine

Products with which the motors can be combined are listed below.

The box (■) in the driver model name indicates a code representing the driver type.

Blank: Analog setting type **D**: Digital setting type **R**: RS-485 communication type

● BLH Series

Output power	Motor model	Driver model
15 W	BLHM015	BLH2D15 -K■
30 W	BLHM230	BLH2D30 -K■
50 W	BLHM450	BLH2D50 -K■
100 W	BLHM5100	BLHD100K

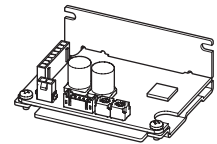

■ Names of parts

The figure shows the combination type-parallel shaft gearhead.

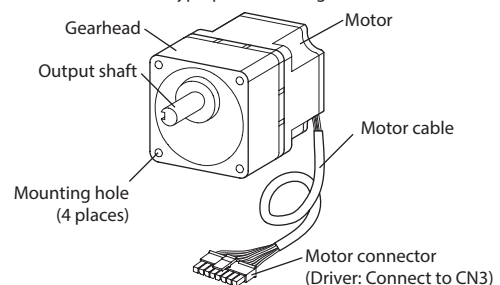

Installation

This section explains the installation method of a load in addition to the installation location and installation method of the product.

■ Installation location

Install the product in a well-ventilated location that provides easy access for inspection. Install it onto an appropriate flat plate having excellent vibration resistance and heat conductivity.

The location must also satisfy the following conditions:

[Common conditions]

- Operating ambient temperature 0 to +50 °C [+32 to 122°F] (non-freezing)
- Operating ambient humidity 85% or less (non-condensing)
- Area that is free of explosive atmosphere or toxic gas (such as sulfuric gas) or liquid
- Area not exposed to direct sun
- Area free of excessive amount of dust, iron particles or the like
- Area free of excessive salt
- Area not subject to continuous vibration or excessive shocks
- Area free of excessive electromagnetic noise (from welders, power machinery, etc.)
- Area free of radioactive materials, magnetic fields or vacuum
- Altitude Up to 1000 m (3300 ft.) above sea level

[Cable type: Degree of protection IP65 rated motor]

- Indoors
 - Not exposed to oil (oil droplets) or chemicals.
- The motor can be used in an environment where it is splashed with water (excluding the connectors and mounting surface of the round shaft type). However, do not use it under water or in high water pressure.

[Lead wire type: Degree of protection IP40 rated motor]

- Inside an enclosure installed indoors (provide a ventilation hole)
- Area not subject to splashing water (rain, water droplets), oil (oil droplets) or other liquids

■ Installation method

● Geared type

Secure the product using hexagonal socket head screws (not included) through the four mounting holes. Do not leave a gap between the product and mounting plate. The effective depth of screw is 8 mm (0.31 in.).

Model	Screw size	Tightening torque [N·m (lb-in)]
BLHM015	M4	1.8 (15.9)

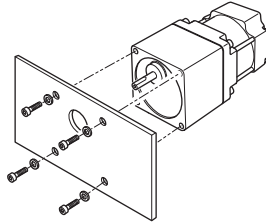

Note Fit the boss section on the gearhead mounting surface into a counterbore or through pilot-receiving hole.

● Combination type-parallel shaft gearhead

Secure the motor and gearhead through four mounting holes using the included hexagonal socket head screws. Do not leave a gap between the product and mounting plate.

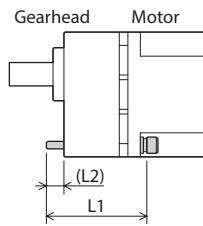
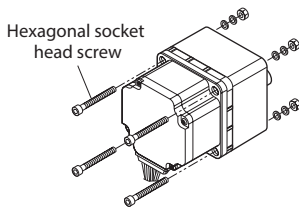

Model	Gear ratio	Hexagonal socket head screw (included)			Tightening torque [N·m (lb-in)]
		Screw size	L1 [mm (in.)]	L2 [mm (in.)]	
BLHM230	5 to 20	M4	50 (1.97)	6 (0.24)	1.8 (15.9)
	30 to 100		55 (2.17)	7 (0.28)	
	200		60 (2.36)	7 (0.28)	
BLHM450	5 to 20	M6	65 (2.56)	13 (0.51)	6.4 (56)
	30 to 100		70 (2.76)	13 (0.51)	
	200		75 (2.95)	13 (0.51)	
BLHM5100	5 to 20	M8	75 (2.95)	16.5 (0.65)	15.5 (137)
	30 to 100		90 (3.54)	18.5 (0.73)	
	200		95 (3.74)	17.5 (0.69)	

Removing and assembling the gearhead

See the following steps to replace the gearhead or to change the cable outlet position.

Removing the gearhead from the motor

Remove the hexagonal socket head screws (2 places) assembling the motor and gearhead, and detach the gearhead from the motor.

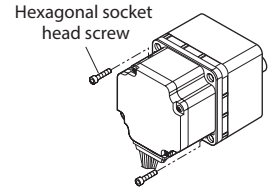

Assembling the gearhead to the motor

1. Keep the pilot sections of the motor and gearhead in parallel, and assemble the gearhead with the motor while slowly rotating it clockwise/counterclockwise.

At this time, note so that the pinion of the motor output shaft does not hit the side panel or gears of the gearhead strongly.

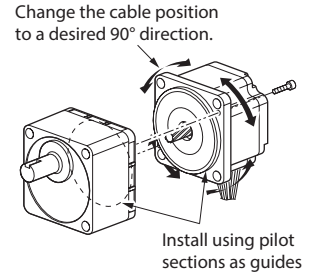

2. Check that there is no gap between the motor and gearhead, and tighten them with hexagonal socket head screws (2 places).

Model	Screw size	Tightening torque [N·m (lb-in)]
BLHM230	M2.6	0.4 (3.5)
BLHM450		
BLHM5100	M3	0.6 (5.3)

- Note**
- Do not forcibly assemble the motor and gearhead. Also, prevent metal objects or foreign substances from entering in the gearhead. The pinion of the motor output shaft or gear may be damaged, resulting in noise or shorter service life.
 - Do not allow dust to attach to the pilot sections of the motor and gearhead. Also, assemble the motor and gearhead carefully by not pinching the O-ring at the motor pilot section. If the O-ring is crushed or severed, grease may leak from the gearhead.

● Round shaft type

Secure the product using hexagonal socket head screws (not included) through the four mounting holes.

Do not leave a gap between the product and mounting plate.

Model	Screw size	Tightening torque [N·m (lb-in)]
BLHM015	M3	1 (8.8)
BLHM230	M4	1.8 (15.9)
BLHM450	M6	6.4 (56)
BLHM5100	M8	15.5 (137)

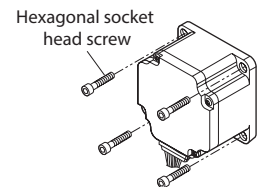

Install the motor to a mounting plate of the following size or larger, so that the motor case temperature will not exceed 90 °C (194 °F)

(The BLH015 has no limitation on the mounting plate size.)

Model	Size of mounting plate	Thickness	Material
BLHM230	115×115 mm (4.53×4.53 in.)	5 mm (0.20 in.)	Aluminum alloy
BLHM450	135×135 mm (5.31×5.31 in.)		
BLHM5100	200×200 mm (7.87×7.87 in.)		

- Note**
- Do not install the motor to the mounting hole diagonally or assemble the motor forcibly. Doing so may cause damage to the flange pilot section, thereby resulting in damage to the motor.

● Combination type-hollow shaft flat gearhead

A combination type-hollow shaft flat gearhead can be installed by using either its front or rear side as the mounting surface.

Secure with the included hexagonal socket head screws through the four mounting holes so as not to leave a gap between the motor and mounting plate. Also, attach the included safety cover to the hollow output shaft on the end opposite from the one where the load shaft is installed.

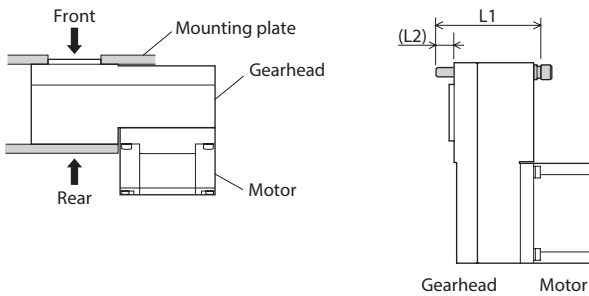

Model	Gear ratio	Hexagonal socket head screw (included)			Tightening torque [N·m (lb-in)]
		Screw size	L1 [mm (in.)]	L2 [mm (in.)]	
BLHM230	5 to 200	M5	65 (2.56)	15 (0.59)	3.8 (33)
BLHM450	5 to 200	M6	70 (2.76)	14 (0.55)	6.4 (56)
BLHM5100	5 to 200	M8	90 (3.54)	21 (0.83)	15.5 (137)

● Using the front side as the mounting surface

When the gearhead is installed by using its front side as the mounting surface, use the boss section of the output shaft to align the center.

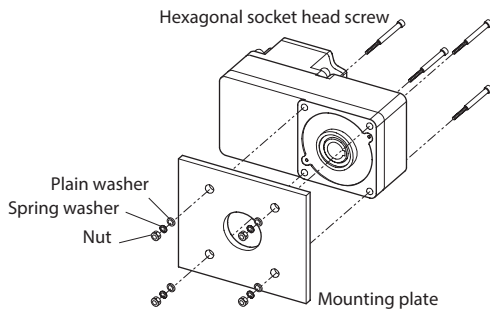

● Using the rear side as the mounting surface

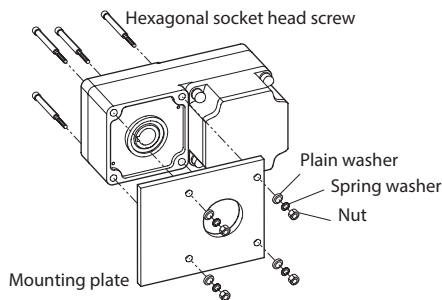

● Installing the safety cover

After installing a load, attach the included safety cover.

The safety cover can be attached to either face.

Tightening torque: 0.45 N·m (3.9 lb-in)

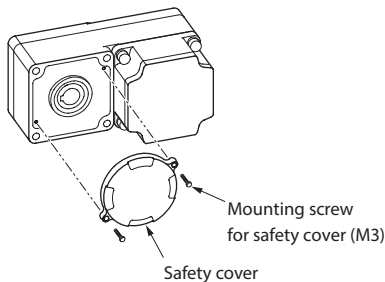

Removing and assembling the gearhead

See the following steps to replace the gearhead or to change the cable outlet position. Note that the motor cable cannot be positioned in the direction where it faces to the gearhead output shaft side.

Removing the gearhead from the motor

Remove the hexagonal socket head screws (4 places) assembling the motor and gearhead, and detach the gearhead from the motor.

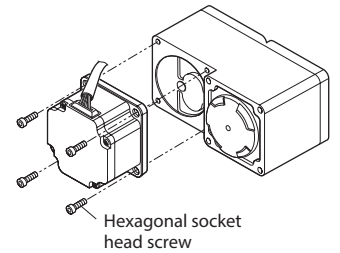

Assembling the gearhead to the motor

1. Keep the pilot sections of the motor and gearhead in parallel, and assemble the gearhead with the motor while slowly rotating it clockwise/counterclockwise. At this time, note so that the pinion of the motor output shaft does not hit the side panel or gears of the gearhead strongly.

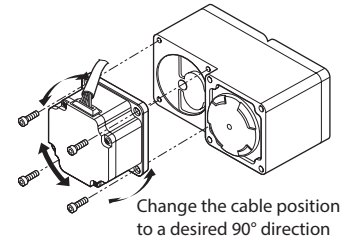

2. Check that there is no gap between the motor and gearhead, and tighten them with hexagonal socket head screws (4 places).

Model	Screw size	Tightening torque [N·m (lb-in)]
BLHM230	M4	1.8 (15.9)
BLHM450	M6	6.4 (56)
BLHM5100	M8	15.5 (137)

Note

- Do not forcibly assemble the motor and gearhead. Also, prevent metal objects or foreign substances from entering in the gearhead. The pinion of the motor output shaft or gear may be damaged, resulting in noise or shorter service life.
- Do not allow dust to attach to the pilot sections of the motor and gearhead. Also, assemble the motor and gearhead carefully by not pinching the O-ring at the motor pilot section. If the O-ring is crushed or severed, grease may leak from the gearhead.

■ Installing a load

Note

- When coupling with a load, pay attention to centering, belt tension, parallelism of pulleys, etc. Also, firmly secure the tightening screws of the coupling or pulleys.
- When installing a load, do not damage the output shaft or bearing. Forcibly inserting the load by driving it with a hammer may damage the bearing. Do not apply any excessive force to the output shaft.
- Do not modify or machine the output shaft. This may damage the bearing, resulting in damage to the motor and gearhead.

● Geared type, combination type-parallel shaft gearhead, round shaft type

When installing a load, align the center of the output shaft with the center of the load shaft.

● Output shaft shape

Combination type-parallel shaft gearhead

A key slot is provided on the output shaft of gearhead. Form a key slot on the load side, and secure the load using the included parallel key.

Model	Parallel key dimension
BLHM230	4 mm (0.1575 in.)
BLHM450	5 mm (0.1969 in.)
BLHM5100	6 mm (0.2362 in.)

Geared type, round shaft type

A flat section is provided on the output shaft of the geared type and round shaft type.

Apply a double-point screw, etc., at the flat section to firmly secure the load and prevent it from spinning.

● How to install a load

Using a coupling

Align the centerline of the output shaft with the centerline of the load shaft.

Using a belt

Adjust the output shaft to lie parallel with the load shaft, and form right angles between the output shaft/load shaft and the line connecting the centers of both pulleys.

Using a gear

Adjust the output shaft to lie parallel with the gear shaft, and allow the output shaft to mesh correctly with the centers of the gear teeth.

When using the output shaft end tapped hole of a gearhead (except for GFS2G)

Use a tap hole provided at the end of the output shaft as an auxiliary means for preventing the transfer mechanism from disengaging.

Gearhead model	Output shaft end tapped hole
GFS4G□	M5, Effective depth 10 mm (0.39 in.)
GFS5G□	M6, Effective depth 12 mm (0.47 in.)

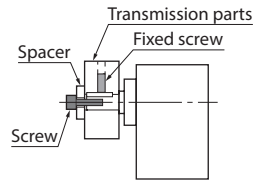

Example of use for output shaft end tapped hole

Combination type-hollow shaft flat gearhead

If a large impact occurs at instantaneous stop or a large radial load is applied, use a stepped load shaft.

Note Apply grease (molybdenum disulfide grease, etc.) on the surface of the load shaft and inner walls of the hollow output shaft to prevent seizure.

Stepped load shaft

Secure the retaining ring to the load shaft by tightening the hexagonal socket head screw over a spacer, plain washer and spring washer.

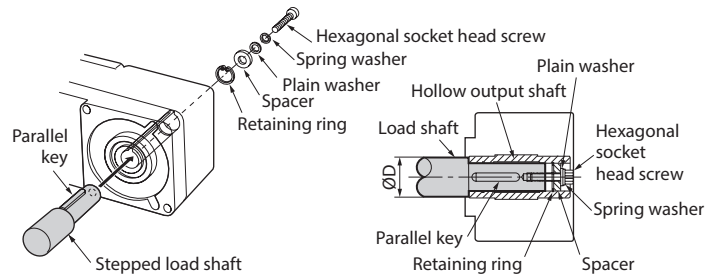

Non-stepped load shaft

Install a spacer on the load shaft side and secure the retaining ring to the load shaft by tightening the hexagonal socket head screw over a spacer, flat washer and spring washer.

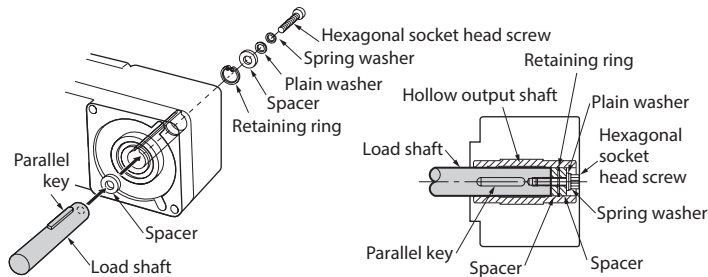

Recommended load shaft installation dimensions [Unit: mm (in.)]

Model	Inner diameter of hollow shaft (H8)	Recommended diameter of load shaft (h7)	Nominal diameter of retaining ring
BLHM230	$\varnothing 12^{+0.027}_0$ ($\varnothing 0.4724^{+0.0011}_0$)	$\varnothing 12^{+0.018}_0$ ($\varnothing 0.4724^{+0.0007}_0$)	$\varnothing 12$ ($\varnothing 0.47$)
BLHM450	$\varnothing 15^{+0.027}_0$ ($\varnothing 0.5906^{+0.0011}_0$)	$\varnothing 15^{+0.018}_0$ ($\varnothing 0.5906^{+0.0007}_0$)	$\varnothing 15$ ($\varnothing 0.59$)
BLHM5100	$\varnothing 20^{+0.033}_0$ ($\varnothing 0.7874^{+0.0013}_0$)	$\varnothing 20^{+0.021}_0$ ($\varnothing 0.7874^{+0.0008}_0$)	$\varnothing 20$ ($\varnothing 0.79$)

Model	Applicable screw	Spacer thickness	Outer diameter of stepped shaft (ØD)
BLHM230	M4	3 (0.12)	20 (0.79)
BLHM450	M5	4 (0.16)	25 (0.98)
BLHM5100	M6	5 (0.20)	30 (1.18)

Permissible radial load and permissible axial load

Make sure a radial load and axial load applied to the output shaft will not exceed the permissible values shown in the table below.

Note Failure due to fatigue may occur when the motor or gearhead bearings and output shaft are subject to repeated loading by a radial or axial load that is in excess of the permissible limit.

Geared type, combination type-parallel shaft gearhead

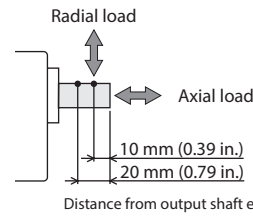

Model	Gear ratio	Permissible radial load [N (lb.)]		Permissible axial load [N (lb.)]
		Distance from output shaft end of the gearhead		
		10 mm (0.39 in.)	20 mm (0.79 in.)	
BLHM015	5 to 100	50 (11.2)	—	30 (6.7)
	5	100 (22)	150 (33)	40 (9)
BLHM230	10 to 20	150 (33)	200 (45)	
	30 to 200	200 (45)	300 (67)	
BLHM450	5	200 (45)	250 (56)	100 (22)
	10 to 20	300 (67)	350 (78)	
BLHM5100	5	300 (67)	400 (90)	150 (33)
	10 to 20	400 (90)	500 (112)	
	30 to 200	500 (112)	650 (146)	

Round shaft type

Model	Permissible radial load [N (lb.)]		Permissible axial load [N (lb.)]
	Distance from output shaft end of the motor		
	10 mm (0.39 in.)	20 mm (0.79 in.)	
BLHM015	50 (11.2)	—	5 (1.12)
BLHM230	70 (15.7)	100 (22)	15 (3.3)
BLHM450	120 (27)	140 (31)	20 (4.5)
BLHM5100	160 (36)	170 (38)	25 (5.6)

Combination type-hollow shaft flat gearhead

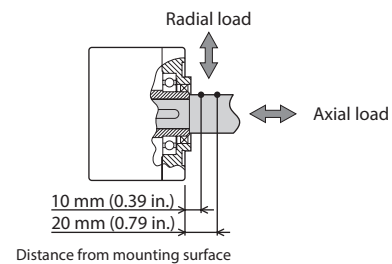

Model	Gear ratio	Permissible radial load [N (lb.)]		Permissible axial load [N (lb.)]
		Distance from gearhead mounting surface		
		10 mm (0.39 in.)	20 mm (0.79 in.)	
BLHM230	5, 10	450 (101)	370 (83)	200 (45)
	15 to 200	500 (112)	400 (90)	
BLHM450	5, 10	800 (180)	660 (148)	400 (90)
	15 to 200	1200 (270)	1000 (220)	
BLHM5100	5, 10	900 (200)	770 (173)	500 (112)
	15, 20	1300 (290)	1110 (240)	
	30 to 200	1500 (330)	1280 (280)	

Grounding

Connect the grounding wire along with a set screw to the grounding point, using a shakeproof washer. For the BLHM015 geared type models, remove the paint from the mounting surface of the geared motor, and install it to a metal surface that has grounded.

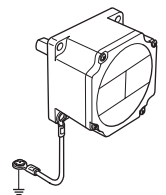

Precautions about static electricity

Static electricity may cause the driver to malfunction or suffer damage. Be sure to ground the motor and driver to prevent them from being damaged by static electricity.

Inspection and maintenance

■ Inspection

It is recommended that periodic inspections would be conducted for the items listed below after each operation of the motor.
If an abnormal condition is noted, discontinue any use and contact your nearest Oriental Motor sales office.



Do not conduct the insulation resistance measurement or dielectric strength test with the motor and driver connected. Conducting the insulation resistance measurement or dielectric strength test with the motor and driver connected may result in damage to the product.

● Inspection item

- Check if any of the mounting screws of the motor and gearhead is loose.
- Check if the bearing part (ball bearings) of the motor generates unusual noises.
- Check if the bearing part (ball bearings) or gear meshing part of the gearhead generates unusual noises.
- Check if the output shaft of the motor and gearhead and a load shaft are out of alignment.
- Check if a damage or stress is applied on the cable or the connection part between the cable and driver is loose.

■ Warranty

Check on the Oriental Motor Website for the product warranty.

■ Disposal

Dispose the product correctly in accordance with laws and regulations, or instructions of local governments.

Specifications

Check on the Oriental Motor Website for the product specifications.

General specifications

Operating environment	Ambient temperature	0 to +50 °C [+32 to +122 °F] (non-freezing)
	Ambient humidity	85% or less (non-condensing)
	Altitude	Up to 1000 m (3300 ft.) above sea level
	Surrounding atmosphere	No corrosive gas, dust or oil. Cannot be used in radioactive materials, magnetic field, vacuum or other special environment.
	Vibration	Not subject to continuous vibrations or excessive impact. In conformance with JIS C 60068-2-6 "Sine-wave vibration test method" Frequency range: 10 to 55 Hz Pulsating amplitude: 0.15 mm (0.006 in.) Sweep direction: 3 directions (X, Y, Z) Number of sweeps: 20 times
Storage environment Shipping environment	Ambient temperature	-25 to +70 °C [-13 to +158 °F] (non-freezing)
	Ambient humidity	85% or less (non-condensing)
	Altitude	Up to 3000 m (10000 ft.) above sea level
	Surrounding atmosphere	No corrosive gas, dust, water or oil. Cannot be used in radioactive materials, magnetic field, vacuum or other special environment.
Degree of protection *	IP65 (Excluding the mounting surface of the round shaft type and connectors)	

* Lead wire type : IP40

Regulations and standards

■ UL Standards, CSA Standards

This product is recognized by UL under the UL and CSA Standards.

■ EU RoHS Directive/UK RoHS Regulation

This product does not contain the substances exceeding the restriction values.

- Unauthorized reproduction or copying of all or part of this manual is prohibited.
- Oriental Motor shall not be liable whatsoever for any problems relating to industrial property rights arising from use of any information, circuit, equipment or device provided or referenced in this manual.
- Characteristics, specifications and dimensions are subject to change without notice.
- While we make every effort to offer accurate information in the manual, we welcome your input. Should you find unclear descriptions, errors or omissions, please contact the nearest office.
- **Orientalmotor** is a registered trademark or trademark of Oriental Motor Co., Ltd., in Japan and other countries.

© Copyright ORIENTAL MOTOR CO., LTD. 2018

Published in November 2022

- Please contact your nearest Oriental Motor office for further information.

ORIENTAL MOTOR U.S.A. CORP.
Technical Support Tel:800-468-3982
8:30am EST to 5:00pm PST (M-F)
www.orientalmotor.com

ORIENTAL MOTOR (EUROPA) GmbH
Schiesstraße 44, 40549 Düsseldorf, Germany
Technical Support Tel:00 800/22 55 66 22
www.orientalmotor.de

ORIENTAL MOTOR (UK) LTD.
Unit 5 Faraday Office Park, Rankine Road,
Basingstoke, Hampshire RG24 8QB UK
Tel:+44-1256347090
www.oriental-motor.co.uk

ORIENTAL MOTOR (FRANCE) SARL
Tel:+33-1 47 86 97 50
www.orientalmotor.fr

ORIENTAL MOTOR ITALIA S.r.l.
Tel:+39-02-93906347
www.orientalmotor.it

ORIENTAL MOTOR CO., LTD.
4-8-1Higashiueno,Taito-ku,Tokyo 110-8536
Japan
Tel:+81-3-6744-0361
www.orientalmotor.co.jp

ORIENTAL MOTOR ASIA PACIFIC PTE. LTD.
Singapore
Tel:1800-842-0280
www.orientalmotor.com.sg

ORIENTAL MOTOR (MALAYSIA) SDN. BHD.
Tel:1800-806-161
www.orientalmotor.com.my

ORIENTAL MOTOR (THAILAND) CO., LTD.
Tel:1800-888-881
www.orientalmotor.co.th

ORIENTAL MOTOR (INDIA) PVT. LTD.
Tel:1800-120-1995 (For English)
1800-121-4149 (For Hindi)
www.orientalmotor.co.in

TAIWAN ORIENTAL MOTOR CO., LTD.
Tel:0800-060708
www.orientalmotor.com.tw

SHANGHAI ORIENTAL MOTOR CO., LTD.
Tel:400-820-6516
www.orientalmotor.com.cn

INA ORIENTAL MOTOR CO., LTD.
Korea
Tel:080-777-2042
www.inaom.co.kr